



PEMERINTAH KOTA SAMARINDA
PROGRAM PEMBANGUNAN DAN PEMBERDAYAAN MASYARAKAT
PRO BEBAYA
RENCANA ANGGARAN BIAYA (RAB)

KEGIATAN :
PEMBERDAYAAN KELURAHAN

SUB KEGIATAN :
PEMBANGUNAN SARANA DAN PRASARANA KELURAHAN

PEKERJAAN :
SEMENISASI JALAN
(9M X 4M X 0,15M = 5,4 M3)

LOKASI :
JL. REEL 10, RT. 25, KELURAHAN SUNGAI KELEDANG,
KECAMATAN SAMARINDA SEBERANG

TAHUN ANGGARAN
2023

REKAPITULASI RAB PRO-BEBAYA 2023**BIDANG INFRASTRUKTUR**

Kota : SAMARINDA

Kegiatan : SEMENISASI JALAN

Kecamatan : SAMARINDA SEBERANG

Volume : 9 m X 4 m X 0,15 m = 5,4 m³

Kelurahan : SUNGAI KELEDANG

Lokasi : RT 25, Jl. Reel 10

No.	URAIAN KEGIATAN	HARGA PEKERJAAN (Rp)
I	SEMENISASI JALAN	10.219.800,00
	Sub Total	10.219.800,00
	Ppn 11%	1.124.178,00
	Jumlah	11.343.978,00
	Dibulatkan	11.343.000,00

Terbilang : "SEBELAS JUTA TIGA RATUS EMPAT PULUH TIGA RIBU RUPIAH"

**RENCANA ANGGARAN DAN BIAYA
BIDANG INFRASTRUKTUR**

Kota : SAMARINDA
Kecamatan : SAMARINDA SEBERANG
Kelurahan : SUNGAI KELEDANG

Kegiatan : SEMENISASI JALAN
Volume : 9 m X 4 m X 0,15 m = 5,4 m³
Lokasi : RT 25, Jl. Reel 10

NO	URAIAN	SATUAN	VOLUME	HARGA SATUAN	TOTAL BIAYA
				Rp	Rp
1	2	3	4	5	6 = 4+5
1	UPAH KERJA				
	1. Tukang	HOK	3,0	150.000,00	450.000,00
	2. Pekerja	HOK	10,0	110.000,00	1.100.000,00
				Jumlah 1	1.550.000,00
2	BAHAN				
	1. Semen 50 Kg	Sak	36,0	68.000,00	2.448.000,00
	2. Pasir Palu	M3	3,5	575.000,00	2.012.500,00
	3. Batu Pecah 2-3	M3	4,5	500.000,00	2.250.000,00
	4. Kayu Perancah	M3	0,11	2.200.000,00	242.000,00
	5. Paku Kayu 0,5"-1,5"	Kg	1,0	26.000,00	26.000,00
	6. Plastik Cor	M2	42,0	2.750,00	115.500,00
	7. Benang Bangunan	Bh	2,0	7.000,00	14.000,00
	8. Plywood 9mm	Lembar	1,0	126.500,00	126.500,00
	9. Obat Cor	Kg	0,8	165.000,00	135.300,00
				Jumlah 2	7.369.800,00
3	ALAT BANTU				
	1. Sewa Molen	Unit/Hari	2,0	350.000,00	700.000,00
	2. Arco	Bh	1,0	600.000,00	600.000,00
				Jumlah 3	1.300.000,00
				Total Biaya (1+2+3)	10.219.800,00

 Mengetahui/menyetujui,
 Lurah Sungai Keledang

 RAHMADI, S.P.
 Nip. 19820831 200502 1 004

Pendamping,

 INDRA PERMANA R.

 Ketua Tim Perencana,

 ARSYAD



PEMERINTAH KOTA SAMARINDA
PROGRAM PEMBANGUNAN DAN PEMBERDAYAAN MASYARAKAT
PRO BEBAYA
GAMBAR RENCANA

KEGIATAN :
PEMBERDAYAAN KELURAHAN
SUB KEGIATAN :
PEMBANGUNAN SARANA DAN PRASARANA KELURAHAN
PEKERJAAN :
SEMENISASI JALAN (9 M X 4 M X 0,15 M = 5,4 M3)
LOKASI :
JL. REEL 10, RT. 25, KEL. SUNGAI KELEDANG, KEC. SAMARINDA SEBERANG
TAHUN ANGGARAN
2023



PEMERINTAH KOTA SAMARINDA

KEGIATAN

PEMBERIDAYAAN KELURAHAN

SUB KEGIATAN

PEMANGUNAN SARANA DAN PRASARANA KELURAHAN

PEKERJAAN

SEMENIASI JALAN
9 M X 4 M X 0.15 M = 6,0 M³

LOKASI

Jl. Reel 10, RT.25,
Kelurahan Sungai Keledang,
Kecamatan Samarinda Seberang

MENGETAHUI/MENYETUJUI

LURAH SINGKAI KEDEWANG

ALMAADI, S.P.
No. 1000001/20092/1/004

TEMAKA PENDAMPING

Incha Permama Kaffadani

TIM PERENCANA

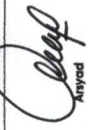

Aryad

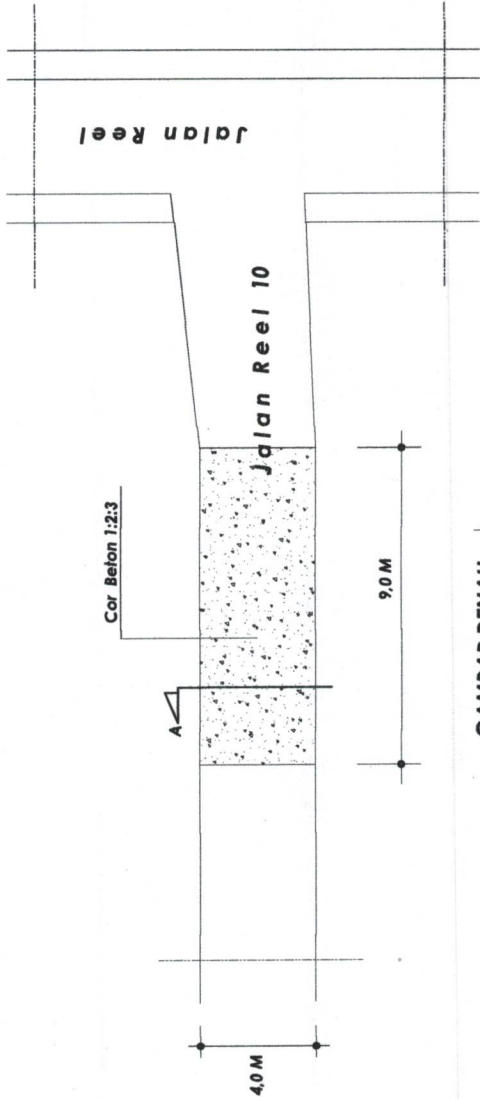
KETERANGAN



GAMBAR DENAH

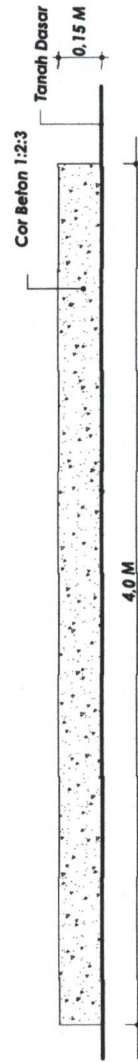



Skala 1 : 100



DETAIL POTONGAN A

Skala 1 : ...



 PEMERINTAH KOTA SAMARINDA
KEGIATAN PEMBERDAYAAN KELURAHAN
SUB KEGIATAN PENGANGKATAN SARANA DAN PRASARANA KELURAHAN
PEREKLEJAAN SEMANGSASI JALAN 9 M. X 4 M X 0.15 M = 6 M3
LOKASI Jl. Reel 10, RT.25, Kelurahan Sungai Keledang, Kecamatan Samarinda Seberang
MENGEHAHUI / MENYETUJUI LURAH SUNGAI KELEDANG  L. HAMADI, S.P. No. P.000001.200001.004
TEMAGA PENDAMPING  Indra Firmansyah (Kamudani)
TIM PERENCANA  Masyud
KETERANGAN

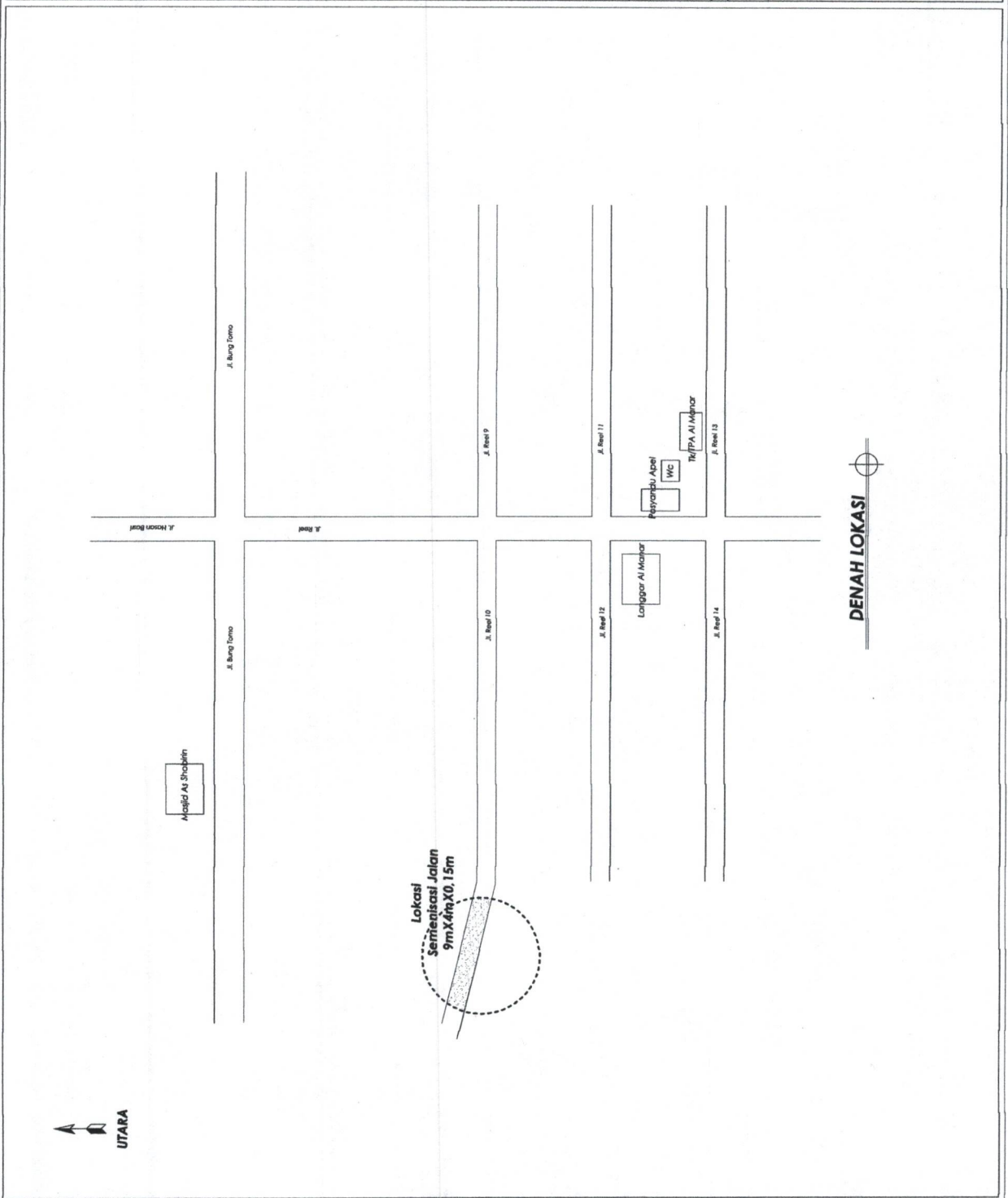

DENAH LOKASI



PEMERINTAH KOTA SAMARINDA
PROGRAM PEMBANGUNAN DAN PEMBERDAYAAN MASYARAKAT
PRO BEBAYA
RENCANA ANGGARAN BIAYA (RAB)

KEGIATAN :
PEMBERDAYAAN KELURAHAN

SUB KEGIATAN :
PEMBANGUNAN SARANA DAN PRASARANA KELURAHAN

PEKERJAAN :
SEMENISASI JALAN
(25M X 1,0M X 0,12M = 3,06 M3)

LOKASI :
JL. REEL 3, RT. 26, GANG PULAU, KEL. SUNGAI KELEDANG, KEC. SAMARINDA SEBERANG
KECAMATAN SAMARINDA SEBERANG

TAHUN ANGGARAN
2023

REKAPITULASI RAB PRO-BEBAYA 2023**BIDANG INFRASTRUKTUR**

Kota : SAMARINDA
Kecamatan : SAMARINDA SEBERANG
Kelurahan : SUNGAI KELEDANG

Kegiatan : SEMENISASI JALAN
Volume : 25 m X 1 m X 0,12 m = 3,0 M3
Lokasi : RT 26, JL. REEL 3, GANG PULAU

No.	URAIAN KEGIATAN	HARGA PEKERJAAN (Rp)
I	SEMENISASI JALAN	7.299.200,00
	Sub Total	7.299.200,00
	Ppn 11%	802.912,00
	Jumlah	8.102.112,00
	Dibulatkan	8.102.000,00

Terbilang : "DELAPAN JUTA SERATUS DUA RIBU RUPIAH"

**RENCANA ANGGARAN DAN BIAYA
BIDANG INFRASTRUKTUR**

Kota : SAMARINDA
Kecamatan : SAMARINDA SEBERANG
Kelurahan : SUNGAI KELEDANG

Kegiatan : SEMENISASI JALAN
Volume : 25 m X 1 m X 0,12 m = 3,0 M3
Lokasi : RT 26, JL. REEL 3, GANG PULAU

NO	URAIAN	SATUAN	VOLUME	HARGA SATUAN	TOTAL BIAYA
				Rp	Rp
1	2	3	4	5	6 = 4+5
1	UPAH KERJA				
	1. Tukang	HOK	3,0	150.000,00	450.000,00
	2. Pekerja	HOK	9,0	110.000,00	990.000,00
				Jumlah 1	1.440.000,00
2	BAHAN				
	1. Semen 50 Kg	Sak	20,00	68.000,00	1.360.000,00
	2. Pasir Palu	M3	2,00	575.000,00	1.150.000,00
	3. Batu Pecah 2-3	M3	2,50	500.000,00	1.250.000,00
	4. Kayu Perancah	M3	0,24	2.200.000,00	528.000,00
	5. Paku Kayu 0,5"-1,5"	Kg	2,40	26.000,00	62.400,00
	6. Plastik Cor	M2	31,00	2.750,00	85.250,00
	7. Plywood 9mm	Lembar	2,50	126.500,00	316.250,00
	8. Obat Cor	Kg	0,82	165.000,00	135.300,00
				Jumlah 2	4.887.200,00
3	ALAT BANTU				
	1. Sewa Molen	Unit/Hari	1,00	350.000,00	350.000,00
	2. Arco	Bh	1,00	600.000,00	600.000,00
	3. Keranjang Rotan	Bh	1,00	22.000,00	22.000,00
				Jumlah 3	972.000,00
				Total Biaya (1+2+3)	7.299.200,00



Mengetahui/menyetujui,
Lurah Sungai Keledang

RAMMADI, S.P.

Nip. 19820831 200502 1 004

Pendamping,

INDRA PERMANA R.



Ketua Tim Perencana,

ARSYAD



PEMERINTAH KOTA SAMARINDA

**PROGRAM PEMBANGUNAN DAN PEMBERDAYAAN MASYARAKAT
PRO BEBAYA**

GAMBAR RENCANA

KEGIATAN :

PEMBERDAYAAN KELURAHAN

SUB KEGIATAN :

PEMBANGUNAN SARANA DAN PRASARANA KELURAHAN





PEKERJAAN :

SEMENISASI JALAN (25 M X 1 M X 0,12 M = 3,0 M3)

LOKASI :

**JL. REEL 3, RT. 26, GANG PULAU, KEL. SUNGAI KELEDANG, KEC. SAMARINDA SEBERANG
TAHUN ANGGARAN**

2023

	PEMERINTAH KOTA SAMARINDA
KEGIATAN	PEMBERIDAYAAN KELURAHAN
SUB KEGIATAN	PEMBANGUNAN SARANA DAN PRASARANA KELURAHAN
PEKERJAAN	SEMENISASI JALAN 25 M X 1 M X 0,12 M = 3,0 M ³
LOKASI	Jl. Reel 3, Gang Pulau, RT.26, Kelurahan Sungai Keledang, Kecamatan Samarinda Seberang
MENGEWAHI / MENYETUJUI	LURAH SUNGAI KELEDANG  M. M. M. M. S. P. No. 12345678901004
TENAGA PEMBANGUNAN	 Indo Permana Hartadanti
TIM PERENCANA	 Andiand
KETERANGAN	

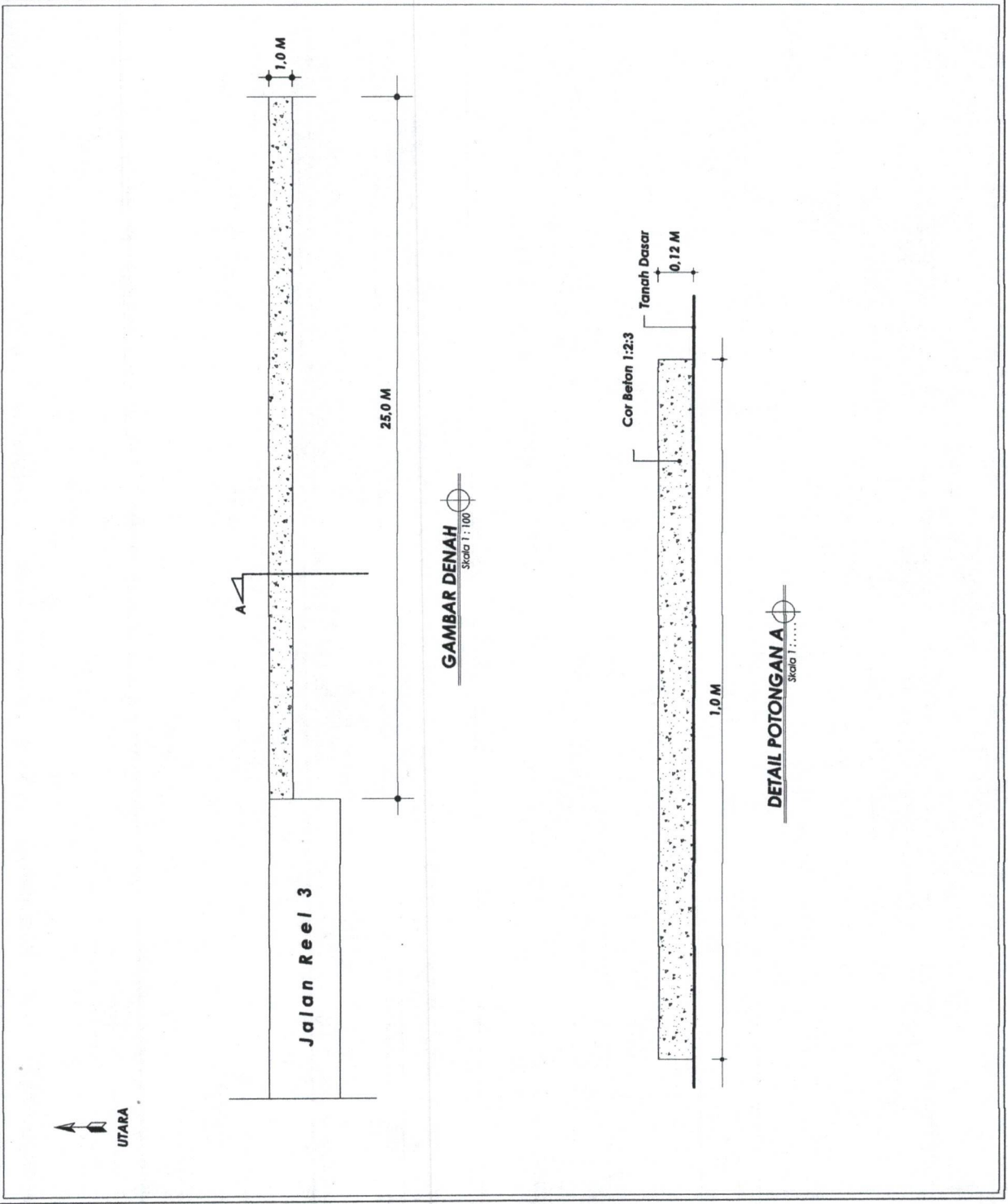



PEMERINTAH KOTA SAMARINDA

KEGIATAN

PEMBERDAYAAN KELURAHAN

SUB KEGIATAN

PENBANGUNAN SARANA DAN PRASARANA KELURAHAN

PEKERJAAN

SEMENBESI JALAN
25 M X 1 M X 0,12 M = 3,0 M³

LOKASI

Jl. Reel 3, Gang Pulau, RT.26,
Kelurahan Sungai Keledang,
Kecamatan Samarinda Seberang

MENGETAHUI / MENYETUJUI

LURAH SUNGAI KELEDANG

[Signature]
R. M. HADI, S.P.
No. 10001/2000/1/004

TENAGA PENDAMPING

[Signature]
Indra Yermans Ramadani

TIM PERENCANA

[Signature]
Atsyad

KETERANGAN

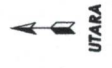
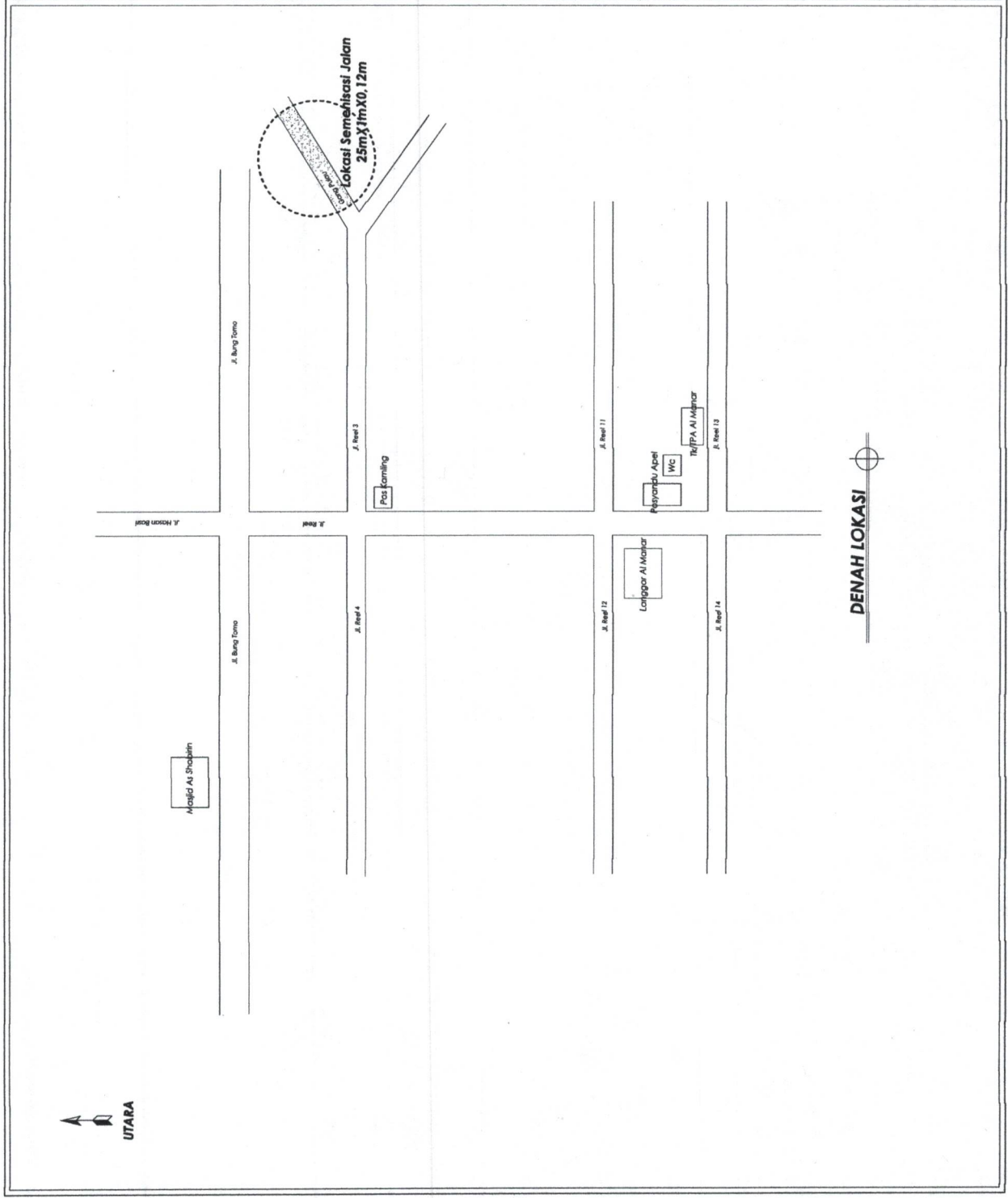

DENAH LOKASI



PEMERINTAH KOTA SAMARINDA
PROGRAM PEMBANGUNAN DAN PEMBERDAYAAN MASYARAKAT
PRO BEBAYA
RENCANA ANGGARAN BIAYA (RAB)

KEGIATAN :
PEMBERDAYAAN KELURAHAN

SUB KEGIATAN :
PEMBANGUNAN SARANA DAN PRASARANA KELURAHAN

PEKERJAAN :
SEMENISASI JALAN
(50M X 3M X 0,15M = 22,5 M3)

LOKASI :
JL. BUNG TOMO, RT.27, GG. SWADAYA, KELURAHAN SUNGAI KELEDANG
KECAMATAN SAMARINDA SEBERANG

TAHUN ANGGARAN
2023

REKAPITULASI RAB PRO-BEBAYA 2023**BIDANG INFRASTRUKTUR**

Kota : SAMARINDA

Kegiatan : SEMENISASI JALAN

Kecamatan : SAMARINDA SEBERANG

Volume : 50 m X 3 m X 0,15 m = 22,5 M3

Kelurahan : SUNGAI KELEDANG

Lokasi : Jl. Bung Tomo, RT 27, Gg. Swadaya 1

No.	URAIAN KEGIATAN	HARGA PEKERJAAN (Rp)
I	SEMENISASI JALAN	40.754.885,00
	Sub Total	40.754.885,00
	Ppn 11%	4.483.037,35
	Jumlah	45.237.922,35
	Dibulatkan	45.237.000,00

Terbilang : "EMPAT PULUH LIMA JUTA DUA RATUS TIGA PULUH TUJUH RIBU RUPIAH"

**RENCANA ANGGARAN DAN BIAYA
BIDANG INFRASTRUKTUR**

Kota : SAMARINDA
Kecamatan : SAMARINDA SEBERANG
Kelurahan : SUNGAI KELEDANG

Kegiatan : SEMENISASI JALAN
Volume : 50 m X 3 m X 0,15 m = 22,5 M3
Lokasi : Jl. Bung Tomo, RT 27, Gg. Swadaya 1

NO	URAIAN	SATUAN	VOLUME	HARGA SATUAN	TOTAL BIAYA
				Rp	Rp
1	2	3	4	5	6 = 4+5
1	UPAH KERJA				
	1. Tukang	HOK	12,00	150.000,00	1.800.000,00
	2. Pekerja	HOK	48,00	110.000,00	5.280.000,00
				Jumlah 1	7.080.000,00
2	BAHAN				
	1. Semen	Sak	147,00	68.000,00	9.996.000,00
	2. Pasir Palu	M3	13,00	575.000,00	7.475.000,00
	3. Batu Pecah 2-3	M3	18,00	500.000,00	9.000.000,00
	4. Kayu Perancah	M3	0,72	2.200.000,00	1.584.000,00
	5. Paku Kayu 0,5"-1,5"	Kg	7,00	26.000,00	182.000,00
	6. Plastik Cor	M2	165,00	2.750,00	453.750,00
	7. Benang Bangunan	Bh	4,00	7.000,00	28.000,00
	8. Plywood 9mm	Lembar	6,00	126.500,00	759.000,00
	9. Obat Cor	Kg	0,82	165.000,00	135.135,00
				Jumlah 2	29.612.885,00
3	ALAT BANTU				
	1. Sewa Molen	Unit/Hari	4,0	350.000,00	1.400.000,00
	2. Arco	Bh	3,0	600.000,00	1.800.000,00
	3. Skop	Bh	4,0	65.000,00	260.000,00
	4. Cangkul + Gagang	Bh	2,0	125.000,00	250.000,00
	5. Keranjang Rotan	Bh	6,0	22.000,00	132.000,00
	6. Cetok	Bh	4,0	15.000,00	60.000,00
	7. Kasutan	Bh	5,0	15.000,00	75.000,00
	8. Gergaji	Bh	1,0	85.000,00	85.000,00
				Jumlah 3	4.062.000,00
				Total Biaya (1+2+3)	40.754.885,00

Mengetahui/menyetujui,
Lurah Sungai Keledang



RAHMADI, S.P.
Nip. 19820831 200502 1 004

Pendamping,

INDRA PERMANA R.

Ketua Tim Perencana,



ARSYAD









PEMERINTAH KOTA SAMARINDA
PROGRAM PEMBANGUNAN DAN PEMBERDAYAAN MASYARAKAT
PRO BEBAYA





GAMBAR RENCANA

KEGIATAN :
PEMBERDAYAAN KELURAHAN
SUB KEGIATAN :
PEMBANGUNAN SARANA DAN PRASARANA KELURAHAN
PEKERJAAN :
SEMENISASI JALAN (50 M X 3 M X 0,15 M = 22,5 M3)

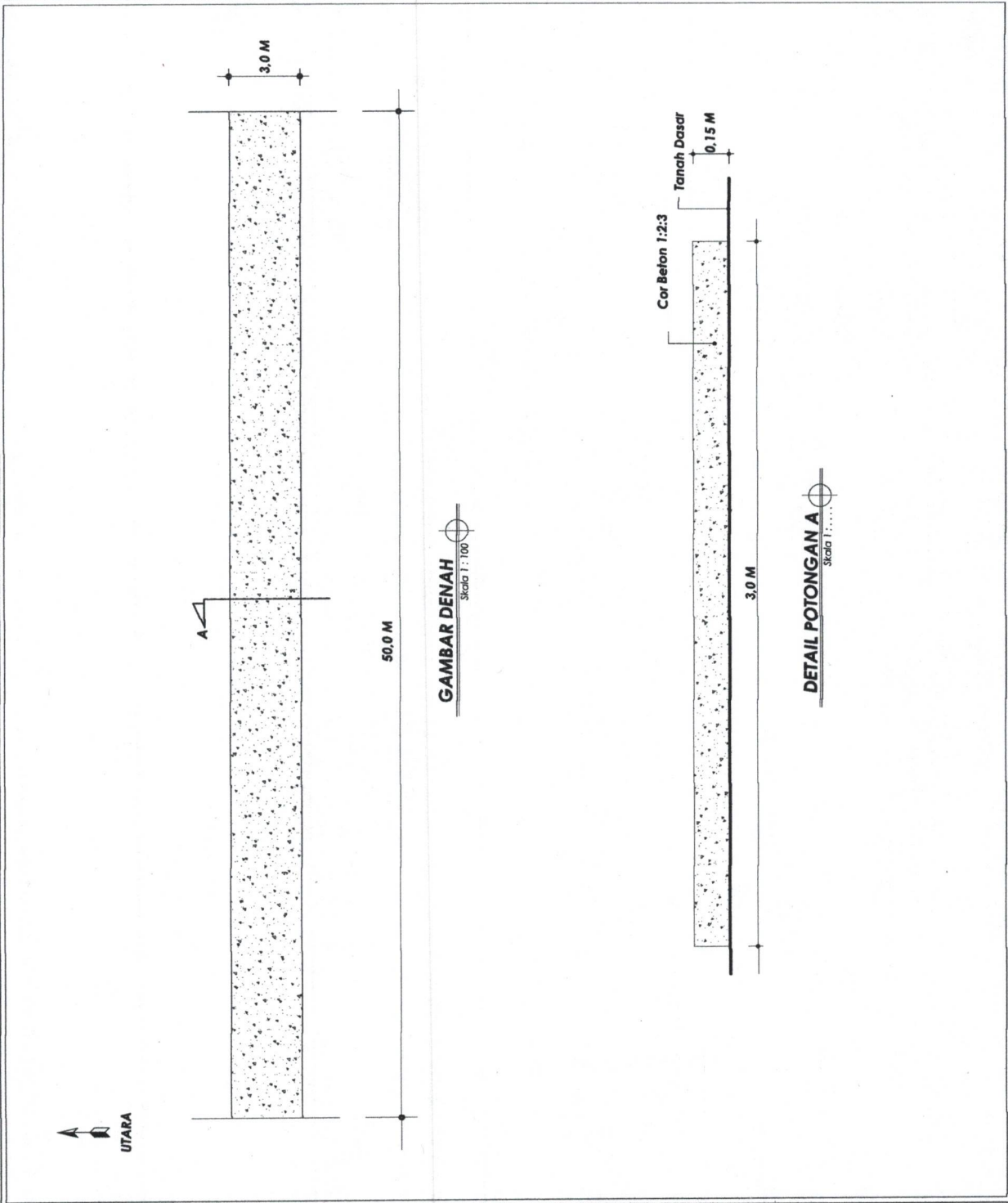
LOKASI :
JL. BUNG TOMO, RT. 27, GANG SWADAYA 1, KEL. SUNGAI KELEDANG, KEC. SAMARINDA SEBERANG
TAHUN ANGGARAN
2023

PEMERINTAH KOTA SAMARINDA
KEGIATAN
PEMBERDAYAAN KELURAHAN
SUB KEGIATAN
PEMBANGUNAN SARANA DAN PRASARANA KELURAHAN
PEREJAJAN
SEMENTASI JALAN 80 M X 3 M X 0,15 M = 22,5 M ³
LOKASI
Jl. Bung Tomo, Gang Swadaya 1, RT.27, Kelurahan Sungai Keledang, Kecamatan Samarinda Seberang
MENGETAHUI/ MENYERUJI
LURAH SUNGAI KELEDANG
 S. H. H. H. S. H. No. P/2020/01/2020/1/04
TENAGA PENDAMPING
 Indra Permata Ramadani
TIM PENGACARA
 Anyad
KETERANGAN



PEMERINTAH KOTA SAMARINDA
KEGIATAN
PEMBERDAYAAN KELURAHAN
SUB KEGIATAN
PEMBANGUNAN SARANA DAN PRASARANA KELURAHAN
PEKERJAAN
SEMENISASI JALAN 50 M X 3 M X 0,15 M = 22,5 M ³
LOKASI
Jl. Bung Tomo, Gang Swadaya 1, Rt.27, Kelurahan Sungai Kledang, Kecamatan Samarinda Seberang
MENGETAHUI/ MENYERJUI
LURAH SUNGAI KLEDANG
 BAHADI, P. No. 12345678901004
TEMA GAMPANG
 Indra Permata Tegadani
TIM PEMBINA
 Anyad
KETERANGAN

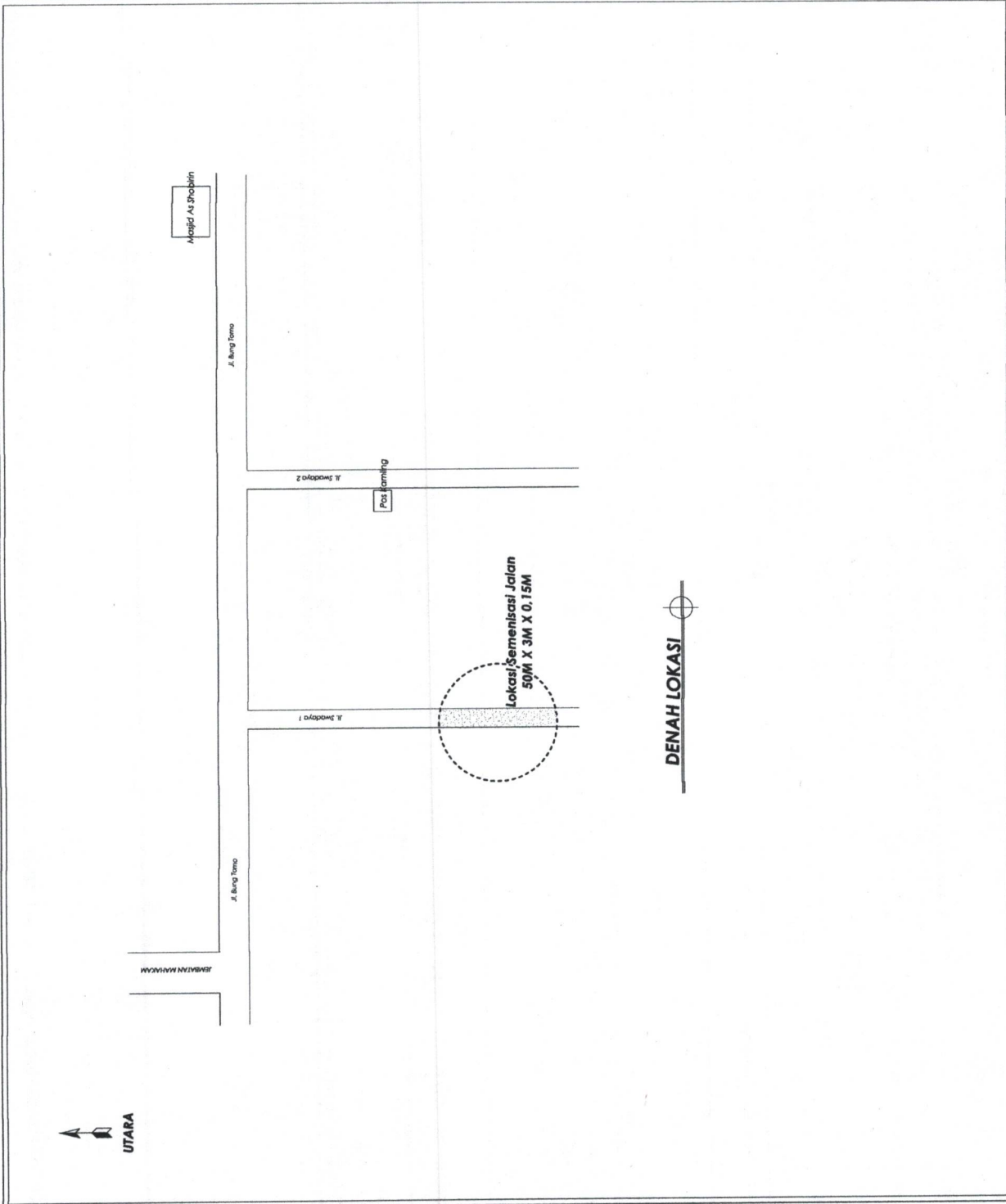



PEMERINTAH KOTA SAMARINDA
PROGRAM PEMBANGUNAN DAN PEMBERDAYAAN MASYARAKAT
PRO BEBAYA
RENCANA ANGGARAN BIAYA (RAB)

KEGIATAN :
PEMBERDAYAAN KELURAHAN

SUB KEGIATAN :
PEMBANGUNAN SARANA DAN PRASARANA KELURAHAN

PEKERJAAN :
SEMENISASI GANG
(15,5M X 3M X 0,15M = 6,93 M3)

LOKASI :
JL. ABDUL SANI GANI, 28, GANG PANDAN WANGI, KELURAHAN SUNGAI KELEDANG
KECAMATAN SAMARINDA SEBERANG

TAHUN ANGGARAN
2023

REKAPITULASI RAB PRO-BEBAYA 2023**BIDANG INFRASTRUKTUR**

Kota : SAMARINDA

Kecamatan : SAMARINDA SEBERANG

Kelurahan : SUNGAI KELEDANG

Kegiatan : Semenisasi Gang

Volume : 15,5 m X 3 m X 0,15 m = 6,98 M3

Lokasi : Jl. Abdul Sani Gani, RT 28, Gang Pandan Wangi

No.	URAIAN KEGIATAN	HARGA PEKERJAAN (Rp)
I	Semenisasi Gang	14.371.118,50
	Sub Total	14.371.118,50
	Ppn 11%	1.580.823,04
	Jumlah	15.951.941,54
	Dibulatkan	15.951.000,00

Terbilang : "LIMA BELAS JUTA SEMBILAN RATUS LIMA PULUH SATU RIBU RUPIAH"

**RENCANA ANGGARAN DAN BIAYA
BIDANG INFRASTRUKTUR**

Kota : SAMARINDA
Kecamatan : SAMARINDA SEBERANG
Kelurahan : SUNGAI KELEDANG

Kegiatan : Semenisasi Gang
Volume : 15,5 m X 3 m X 0,15 m = 6,98 M3
Lokasi : Jl. Abdul Sani Gani, RT 28, Gang Pandan Wangi

NO	URAIAN	SATUAN	VOLUME	HARGA SATUAN	TOTAL BIAYA
				Rp	Rp
1	2	3	4	5	6 = 4+5
1	UPAH KERJA				
	1. Tukang	HOK	4,0	150.000,00	600.000,00
	2. Pekerja	HOK	18,0	110.000,00	1.980.000,00
				Jumlah 1	2.580.000,00
2	BAHAN				
	1. Semen 50 Kg	Sak	46,00	68.000,00	3.128.000,00
	2. Pasir Palu	M3	4,00	575.000,00	2.300.000,00
	3. Batu Pecah 2-3	M3	6,00	500.000,00	3.000.000,00
	4. Kayu Perancah	M3	0,20	2.200.000,00	440.000,00
	5. Paku Kayu 0,5"-1,5"	Kg	3,00	26.000,00	78.000,00
	6. Plastik Cor	M2	60,00	2.750,00	165.000,00
	7. Benang Bangunan	Bh	4,00	7.000,00	28.000,00
	8. Plywood 9mm	Lembar	2,00	126.500,00	253.000,00
	9. Obat Cor	Kg	0,82	165.000,00	135.118,50
				Jumlah 2	9.527.118,50
3	ALAT BANTU				
	1. Sewa Molen	Unit/Hari	1,0	350.000,00	350.000,00
	2. Arco	Bh	2,0	600.000,00	1.200.000,00
	3. Skop	Bh	3,0	65.000,00	195.000,00
	4. Cangkul + Gagang	Bh	2,0	125.000,00	250.000,00
	5. Keranjang Rotan	Bh	7,0	22.000,00	154.000,00
	6. Cetok	Bh	1,0	15.000,00	15.000,00
	7. Kasutan	Bh	1,0	15.000,00	15.000,00
	8. Gergaji	Bh	1,0	85.000,00	85.000,00
				Jumlah 3	2.264.000,00
				Total Biaya (1+2+3)	14.371.118,50

Mengetahui/menyetujui,
Lurah Sungai Keledang



RAHMADI, S.P.
Nip. 19820831 200502 1 004

Pendamping,

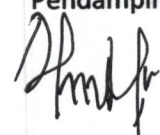

INDRA PERMANA R.

Ketua Tim Perencana,



ARSYAD



PEMERINTAH KOTA SAMARINDA
PROGRAM PEMBANGUNAN DAN PEMBERDAYAAN MASYARAKAT
PRO BEBAYA

GAMBAR RENCANA

KEGIATAN :
PEMBERDAYAAN KELURAHAN
SUB KEGIATAN :
PEMBANGUNAN SARANA DAN PRASARANA KELURAHAN
PEKERJAAN :
SEMENISASI GANG (15,5 M X 3 M X 0,15 M = 6,98 M3)

LOKASI :
JI. ABDUL GANI SANI, GANG PANDAN WANGI, RT. 28, KEL. SUNGAI KELEDANG, KEC. SAMARINDA SEBERANG
TAHUN ANGGARAN
2023



PEMERINTAH KOTA SAMARINDA

KEGIATAN

PEMBERDAYAAN KELURAHAN

SUB KEGIATAN

PEMBANGUNAN SARANA DAN PRASARANA KELURAHAN

PEKERJAAN

SEMENBANGSI JALAN
15,5 M X 3 M X 0,15 M = 6,73 M3

LOKASI

Jl. Abdul Sami Ganti, RT.28, Gang Pandan Wangi,
Kelurahan Sungai Keledang,
Kecamatan Samarinda Seberang

MENGEBAH/ MENYERJUI

LURAH SUNGAI KELEDANG

[Signature]
KAMARUDDIN, S.P.
Korwil Kesra 100

TEKNIK PENYANGKAP

[Signature]
Indra Purnama Kartadani

TIM PERENCANA

[Signature]
Karyadi

KETERANGAN

A
Q
UTARA

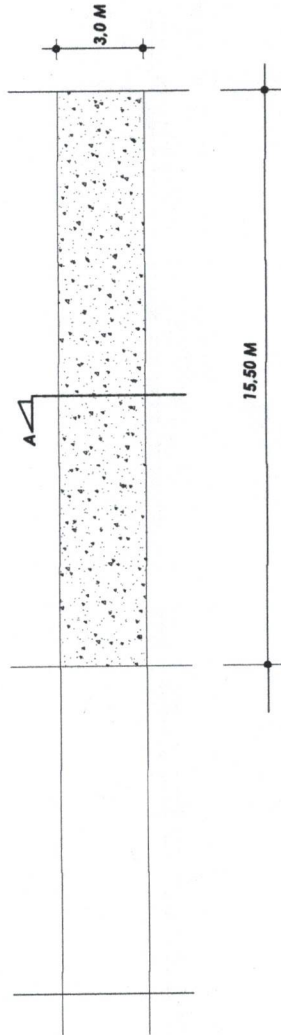

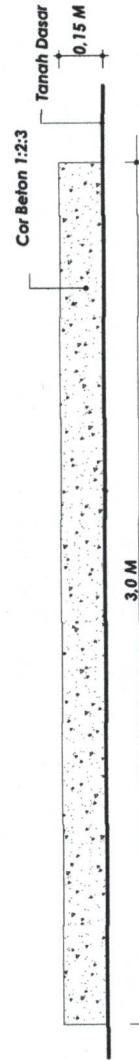

GAMBAR DENAH

Skala 1 : 100



DETAIL POTONGAN A

Skala 1 : 10

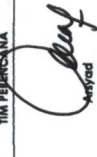
PEMERINTAH KOTA SAMARINDA
KEGIATAN
PEMBERIDAYAAN KELURAHAN
SUB KEGIATAN
PEMBANGUNAN SARANA DAN PRASARANA KELURAHAN
PEKERJAAN
SEMENSIASI JALAN 15,2 M X 3 M X 0,15 M = 6,73 M3
LOKASI
Jl. Abdul Sami Gani, RT.28, Gang Pandan Wangi, Kelurahan Sungai Keledang, Kecamatan Samarinda Seberang
MENGETAHUI/ MENYETUJUI
LURAH SUNGAI KELEDANG  BAHARUDDI, S. NIP. 196301200221004
TEMAGA PENDAMPING  Indra Hermans Kambadani
TIM PEMBERICANA  Harfad
KETERANGAN

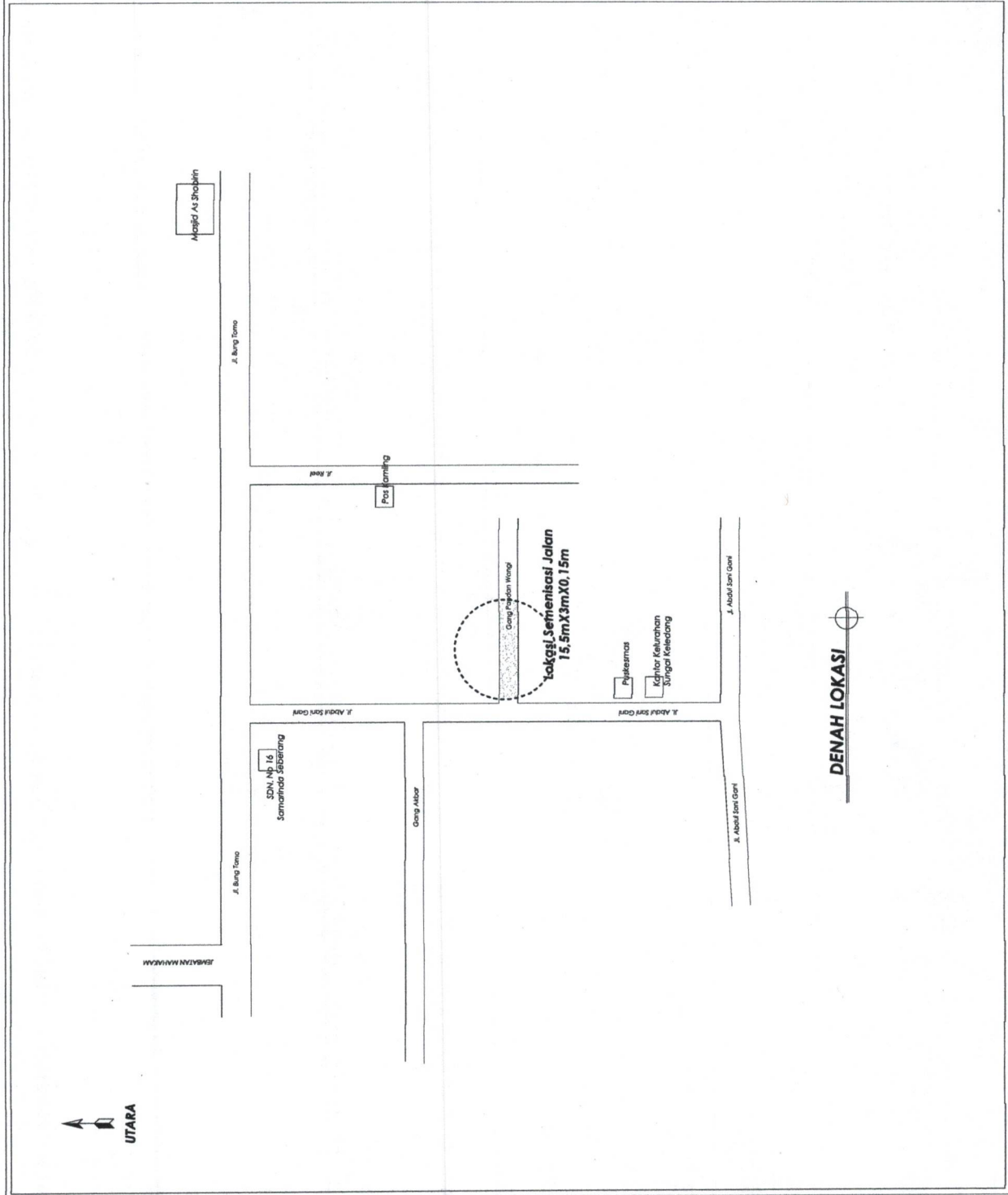



PEMERINTAH KOTA SAMARINDA
PROGRAM PEMBANGUNAN DAN PEMBERDAYAAN MASYARAKAT
PRO BEBAYA
RENCANA ANGGARAN BIAYA (RAB)

KEGIATAN :
PEMBERDAYAAN KELURAHAN

SUB KEGIATAN :
PEMBANGUNAN SARANA DAN PRASARANA KELURAHAN

PEKERJAAN :
SEMENISASI JALAN
(10M X 2M X 0,12M = 2,4 M3)

LOKASI :
JL. ABDUL GANI SANI, RT. 28, KELURAHAN SUNGAI KELEDANG
KECAMATAN SAMARINDA SEBERANG

TAHUN ANGGARAN
2023

REKAPITULASI RAB PRO-BEBAYA 2023**BIDANG INFRASTRUKTUR**

Kota : SAMARINDA

Kegiatan : Semenisasi Jalan

Kecamatan : SAMARINDA SEBERANG

Volume : 10 m X 2 m X 0,12 m = 2,4 M3

Kelurahan : SUNGAI KELEDANG

Lokasi : Jl. Abdul Gani Sani, RT 28

No.	URAIAN KEGIATAN	HARGA PEKERJAAN (Rp)
I	Semenisasi Jalan	5.896.800,00
	Sub Total	5.896.800,00
	Ppn 11%	648.648,00
	Jumlah	6.545.448,00
	Dibulatkan	6.546.000,00

Terbilang : "ENAM JUTA LIMA RATUS EMPAT PULUH ENAM RIBU RUPIAH"

**RENCANA ANGGARAN DAN BIAYA
BIDANG INFRASTRUKTUR**

Kota : SAMARINDA
Kecamatan : SAMARINDA SEBERANG
Kelurahan : SUNGAI KELEDANG

Kegiatan : Semenisasi Jalan
Volume : 10 m X 2 m X 0,12 m = 2,4 M3
Lokasi : Jl. Abdul Gani Sani, RT 28

NO	URAIAN	SATUAN	VOLUME	HARGA SATUAN	TOTAL BIAYA
				Rp	Rp
1	2	3	4	5	6 = 4+5
1	UPAH KERJA				
	1. Tukang	HOK	2,0	150.000,00	300.000,00
	2. Pekerja	HOK	6,0	110.000,00	660.000,00
				Jumlah 1	960.000,00
2	BAHAN				
	1. Semen 50 Kg	Sak	16,00	68.000,00	1.088.000,00
	2. Pasir Palu	M3	1,50	575.000,00	862.500,00
	3. Batu Pecah 2-3	M3	2,00	500.000,00	1.000.000,00
	4. Kayu Perancah	M3	0,10	2.200.000,00	220.000,00
	5. Paku Kayu 0,5"-1,5"	Kg	2,00	26.000,00	52.000,00
	6. Plastik Cor	M2	26,00	2.750,00	71.500,00
	7. Benang Bangunan	Bh	2,00	7.000,00	14.000,00
	8. Plywood 9mm	Lembar	1,00	126.500,00	126.500,00
	9. Obat Cor	Kg	0,82	165.000,00	135.300,00
				Jumlah 2	3.569.800,00
3	ALAT BANTU				
	1. Sewa Molen	Unit/Hari	1,00	350.000,00	350.000,00
	2. Arco	Bh	1,00	600.000,00	600.000,00
	3. Skop	Bh	2,00	65.000,00	130.000,00
	4. Cangkul + Gagang	Bh	1,00	125.000,00	125.000,00
	5. Keranjang Rotan	Bh	6,00	22.000,00	132.000,00
	6. Cetok	Bh	1,00	15.000,00	15.000,00
	7. Kasutan	Bh	1,00	15.000,00	15.000,00
				Jumlah 3	1.367.000,00
				Total Biaya (1+2+3)	5.896.800,00



Mengetahui/menyetujui,
Lurah Sungai Keledang

RAHMADI, S.P.

Nip. 19820831 200502 1 004

Pendamping,

INDRA PERMANA R.



Ketua Tim Perencana,

ARSYAD



PEMERINTAH KOTA SAMARINDA

**PROGRAM PEMBANGUNAN DAN PEMBERDAYAAN MASYARAKAT
PRO BEBAYA**

GAMBAR RENCANA

KEGIATAN :

PEMBERDAYAAN KELURAHAN

SUB KEGIATAN :

PEMBANGUNAN SARANA DAN PRASARANA KELURAHAN

PEKERJAAN :

SEMENISASI JALAN (10 M X 2 M X 0,12 M = 2,4 M³)

LOKASI :

**JL. ABDUL SANI GANI, RT. 28, KELURAHAN SUNGAI KELEDANG, KEC. SAMARINDA SEBERANG
TAHUN ANGGARAN**

2023

UTARA

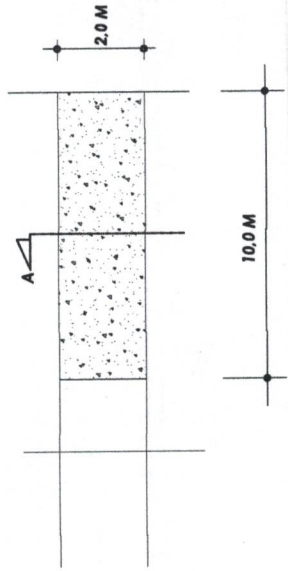

GAMBAR DENAH
Skala 1 : 100

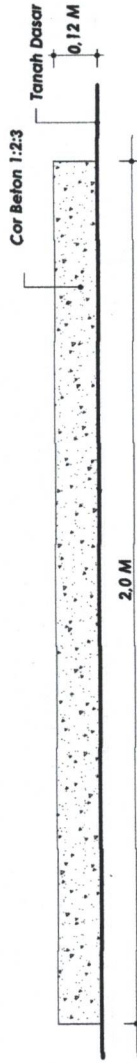

DETAIL POTONGAN A
Skala 1 :



PEMERINTAH KOTA SAMARINDA
KEGIATAN

PEMBERDAYAAN KELURAHAN

SUB KEGIATAN
PMBANGUNAN SARANA DAN
PRASARANA KELURAHAN

PEKERJAAN
SEMENIASI JALAN
10 M X 2 M X 0.12 M = 2.4 M³

LOKASI
Jl. Abdul Sami Gont. RT.28,
Kelurahan Sungai Keladang,
Kecamatan Samarinda Seberang

MENGETAHUI / MENYETUJUI
LURAH SUNGAI KEDELING

[Signature]
SARINDO, S.P
No. 11020001 20002 1 004

TENAGA PENDAMPING

[Signature]
Indra Permata Rospodani

TIM/PERENCANA

[Signature]
Anyad

KETERANGAN



PEMERINTAH KOTA SAMARINDA

KEGIATAN

PEMBERDAYAAN KELURAHAN

SUB KEGIATAN

PEMBANGUNAN SABANA DAN PIASARANA KELURAHAN

PEKERJAAN

SEMENISASI JALAN
10 M X 2 M X 0,12 M = 2,4 M3

LOKASI

Jl. Abdul Sami Gani, RT 28,
Kelurahan Sungai Keledang,
Kecamatan Samarinda Seberang

MENGETAHUI / MENYETUJUI

LURAH SUNGAI KELELANG

[Signature]
EKA WAKILI, S.P.
No. 00100131 20092 1 004

TENAGA PENDAMPING

[Signature]
Indri Permata Permadiani

TIM PEBERKANA

[Signature]
Ansyad

KETERANGAN

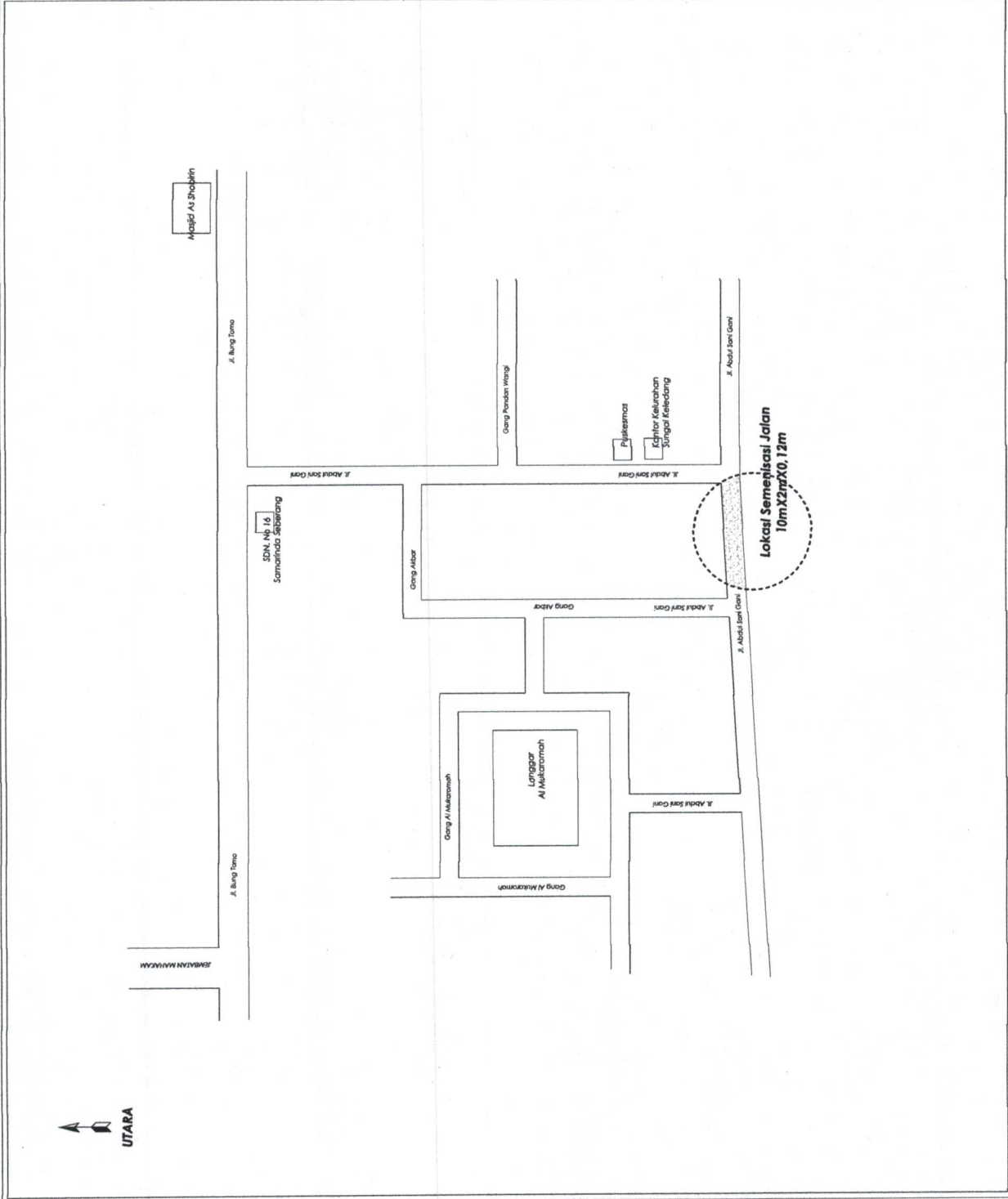

UTARA



PEMERINTAH KOTA SAMARINDA
PROGRAM PEMBANGUNAN DAN PEMBERDAYAAN MASYARAKAT
PRO BEBAYA
RENCANA ANGGARAN BIAYA (RAB)

KEGIATAN :
PEMBERDAYAAN KELURAHAN

SUB KEGIATAN :
PEMBANGUNAN SARANA DAN PRASARANA KELURAHAN

PEKERJAAN :
SEMENISASI GANG
(9,0M X 3M X 0,15M = 4,05 M3)

LOKASI :
JL. ABDUL SANI GANI, RT. 28, GANG AL MUKAROMAH, KELURAHAN SUNGAI KELEDANG
KECAMATAN SAMARINDA SEBERANG

TAHUN ANGGARAN
2023

REKAPITULASI RAB PRO-BEBAYA 2023**BIDANG INFRASTRUKTUR**

Kota : SAMARINDA

Kegiatan : Semenisasi Gang

Kecamatan : SAMARINDA SEBERANG

Volume : 9,0 m X 3 m X 0,15 m = 4,05 M3

Kelurahan : SUNGAI KELEDANG

Lokasi : Jl. Abdul Sani Gani, RT 28, Gang Al Mukaromah

No.	URAIAN KEGIATAN	HARGA PEKERJAAN (Rp)
I	Semenisasi Gang	8.132.618,50
	Sub Total	8.132.618,50
	Ppn 11%	894.588,04
	Jumlah	9.027.206,54
	Dibulatkan	9.027.000,00

Terbilang : "SEMBILA JUTA DUA PULUH TUJUH RIBU RUPIAH"

**RENCANA ANGGARAN DAN BIAYA
BIDANG INFRASTRUKTUR**

Kota : SAMARINDA
Kecamatan : SAMARINDA SEBERANG
Kelurahan : SUNGAI KELEDANG

Kegiatan : Semenisi Gang
Volume : 9,0 m X 3 m X 0,15 m = 4,05 M3
Lokasi : Jl. Abdul Sani Gani, RT 28, Gang Al Mukaromah

NO	URAIAN	SATUAN	VOLUME	HARGA SATUAN	TOTAL BIAYA
				Rp	Rp
1	2	3	4	5	6 = 4+5
1	UPAH KERJA				
	1. Tukang	HOK	2,0	150.000,00	300.000,00
	2. Pekerja	HOK	8,0	110.000,00	880.000,00
				Jumlah 1	1.180.000,00
2	BAHAN				
	1. Semen 50 Kg	Sak	27,00	68.000,00	1.836.000,00
	2. Pasir Palu	M3	2,50	575.000,00	1.437.500,00
	3. Batu Pecah 2-3	M3	3,50	500.000,00	1.750.000,00
	4. Kayu Perancah	M3	0,11	2.200.000,00	242.000,00
	5. Paku Kayu 0,5"-1,5"	Kg	1,00	26.000,00	26.000,00
	6. Plastik Cor	M2	30,00	2.750,00	82.500,00
	7. Benang Bangunan	Bh	1,00	7.000,00	7.000,00
	8. Plywood 9mm	Lembar	1,00	126.500,00	126.500,00
	9. Obat Cor	Kg	0,82	165.000,00	135.118,50
				Jumlah 2	5.642.618,50
3	ALAT BANTU				
	1. Sewa Molen	Unit/Hari	1,0	350.000,00	350.000,00
	2. Arco	Bh	1,0	600.000,00	600.000,00
	3. Skop	Bh	1,0	65.000,00	65.000,00
	4. Cangkul + Gagang	Bh	1,0	125.000,00	125.000,00
	5. Keranjang Rotan	Bh	5,0	22.000,00	110.000,00
	6. Cetok	Bh	2,0	15.000,00	30.000,00
	7. Kasutan	Bh	2,0	15.000,00	30.000,00
				Jumlah 3	1.310.000,00
				Total Biaya (1+2+3)	8.132.618,50

Mengetahui/menyetujui,
Lurah Sungai Keledang



RAHMADI, S.P.
Nip. 19820831 200502 1 004

Pendamping,
INDRA PERMANA R.

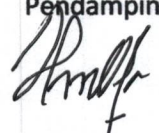

Ketua Tim Perencana,
ARSYAD





PEMERINTAH KOTA SAMARINDA

**PROGRAM PEMBANGUNAN DAN PEMBERDAYAAN MASYARAKAT
PRO BEBAYA**

GAMBAR RENCANA

KEGIATAN :

PEMBERDAYAAN KELURAHAN

SUB KEGIATAN :

PEMBANGUNAN SARANA DAN PRASARANA KELURAHAN

PEKERJAAN :

SEMENISASI GANG (9,0 M X 3 M X 0,15 M = 4,05 M3)

LOKASI :

**JL. ABDUL SANI GANI, RT. 28, GANG AL MUKAROMAH, KEL. SUNGAI KELEDANG, KEC. SAMARINDA SEBERANG
TAHUN ANGGARAN**

2023

UTARA

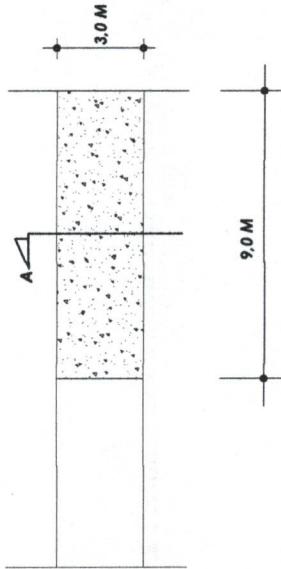

GAMBAR DENAH
Skala 1 : 100

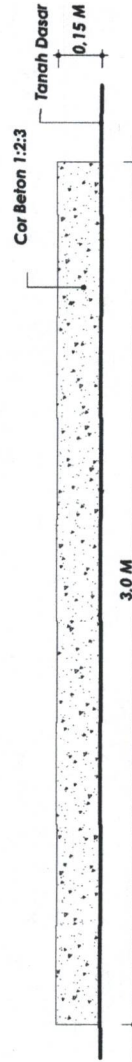

DETAIL POTONGAN A
Skala 1 : ...



PEMERINTAH KOTA SAMARINDA

KEGIATAN

PERBERDAYAAN KELURAHAN

SUB KEGIATAN

PEMBANGUNAN SABANA DAN PRASABANA KELURAHAN

PEKERJAAN

SEMENIASI JALAN

9,0 M X 3 M X 0,15 M = 4,05M³

LOKASI

Jl. Abdul Sani Ganti, RT.28, Gang AL, Mukaramah Kelurahan Sungai Keledang, Kecamatan Samarinda Seberang

MENGETAHUI/ MENYETUJUI

LURAH SUNGAI KELEDANG

[Signature]
KARYAWATI S.P.
No. 12345678901004

TEMAK PENGARIFING

[Signature]
Indra Firmansyah Ramadani

TIM PERENCANA

[Signature]
Ahyada

KETERANGAN



PEMERINTAH KOTA SAMARINDA

KEGIATAN

PEMBERDAYAAN KELURAHAN

SUB KEGIATAN

PEMBERDAYAAN SARANA DAN PRASARANA KELURAHAN

PEKERJAAN

SEMENIASI JALAN
9,0 M X 3 M X 0,15 M = 4,05MS

LOKASI

Jl. Abdul Sami Gani, RT.28, Gang Al Mukaramah
Kelurahan Sungai Keledang,
Kecamatan Samarinda Seberang

MENGEHAHI/ MENYUTUJUI

LURAH SINGAI KELEDANG

[Signature]
A. HADI S.P.
No. 1200001 20003 1 004

TEMAGA PENDAMPING

[Signature]
Indra Ferma Ramadani

TIM PEMBERDAYAAN

[Signature]
Wijaya

KETERANGAN



JERIBATAN MUKYAM

Masjid As Shabirin

Jl. Bung Tamo

Jl. Bung Tamo

SDN. Np 16
Samarinda Seberang

Lokasi Semeniasi Jalan
9,0m x 3m x 0,15m

Langgar
Al Mukaramah

Gang Al Mukaramah

Gang Al Mukaramah

Gang Abdir

Gang Abdir

Gang Pondok Wangi

Paksemas

Kantor Kelurahan
Sungai Keledang

Jl. Abdul Sami Gani

Jl. Abdul Sami Gani



PEMERINTAH KOTA SAMARINDA
PROGRAM PEMBANGUNAN DAN PEMBERDAYAAN MASYARAKAT
PRO BEBAYA
RENCANA ANGGARAN BIAYA (RAB)

KEGIATAN :
PEMBERDAYAAN KELURAHAN

SUB KEGIATAN :
PEMBANGUNAN SARANA DAN PRASARANA KELURAHAN

PEKERJAAN :
SEMENISASI JALAN
(22M X 3,3M X 0,15M = 10,89 M3)

LOKASI :
JL. ABDUL SANI GANI, RT. 29, GG. AKBAR KELURAHAN SUNGAI KELEDANG
KECAMATAN SAMARINDA SEBERANG

TAHUN ANGGARAN
2023

REKAPITULASI RAB PRO-BEBAYA 2023**BIDANG INFRASTRUKTUR**

Kota : SAMARINDA

Kegiatan : Semenisasi Jalan

Kecamatan : SAMARINDA SEBERANG

Volume : 22 m X 3,3 m X 0,15 m = 10,89 M3

Kelurahan : SUNGAI KELEDANG

Lokasi : Jl. Abdul Sani Gani, RT.29, Gang Akbar

No.	URAIAN KEGIATAN	HARGA PEKERJAAN (Rp)
I	Semenisasi Jalan	20.241.550,00
	Sub Total	20.241.550,00
	Ppn 11%	2.226.570,50
	Jumlah	22.468.120,50
	Dibulatkan	22.468.000,00

Terbilang : "DUA PULUH DUA JUTA EMPAT RATUS ENAM PULUH DELAPAN RIBU RUPIAH"

RENCANA ANGGARAN DAN BIAYA
BIDANG INFRASTRUKTUR

Kota : SAMARINDA
Kecamatan : SAMARINDA SEBERANG
Kelurahan : SUNGAI KELEDANG

Kegiatan : Semenisasi Jalan
Volume : 22 m X 3,3 m X 0,15 m = 10,89 M3
Lokasi : Jl. Abdul Sani Gani, RT.29, Gang Akbar

NO	URAIAN	SATUAN	VOLUME	HARGA SATUAN	TOTAL BIAYA
				Rp	Rp
1	2	3	4	5	6 = 4+5
1	UPAH KERJA				
	1. Tukang	HOK	5,0	150.000,00	750.000,00
	2. Pekerja	HOK	24,0	110.000,00	2.640.000,00
				Jumlah 1	3.390.000,00
2	BAHAN				
	1. Semen 50 Kg	Sak	72,0	68.000,00	4.896.000,00
	2. Pasir Palu	M3	6,50	575.000,00	3.737.500,00
	3. Batu Pecah 1-2	M3	9,00	500.000,00	4.500.000,00
	4. Kayu Perancah	M3	0,26	2.200.000,00	572.000,00
	5. Paku Kayu 0,5"-1,5"	Kg	3,00	26.000,00	78.000,00
	6. Plastik Cor	M2	78,00	2.750,00	214.500,00
	7. Benang Bangunan	Bh	3,00	7.000,00	21.000,00
	8. Plywood 9mm	Lembar	2,50	126.500,00	316.250,00
	9. Obat Cor	Kg	0,82	165.000,00	135.300,00
				Jumlah 2	14.470.550,00
3	ALAT BANTU				
	1. Sewa Molen	Unit/Hari	2,0	350.000,00	700.000,00
	2. Arco	Bh	2,0	600.000,00	1.200.000,00
	3. Skop	Bh	1,0	65.000,00	65.000,00
	4. Cangkul + Gagang	Bh	1,0	125.000,00	125.000,00
	5. Keranjang Rotan	Bh	8,0	22.000,00	176.000,00
	6. Cetok	Bh	1,0	15.000,00	15.000,00
	7. Kasutan	Bh	1,0	15.000,00	15.000,00
	8. Gergaji	Bh	1,0	85.000,00	85.000,00
				Jumlah 3	2.381.000,00
				Total Biaya (1+2+3)	20.241.550,00

Mengetahui/menyetujui,
Lurah Sungai Keledang



RAHMADI, S.P.
Nip. 19820831 200502 1 004

Pendamping,



INDRA PERMANA R.

Ketua Tim Perencana,



ARSYAD



PEMERINTAH KOTA SAMARINDA
PROGRAM PEMBANGUNAN DAN PEMBERDAYAAN MASYARAKAT
PRO BEBAYA

GAMBAR RENCANA

KEGIATAN :
PEMBERDAYAAN KELURAHAN
SUB KEGIATAN :
PEMBANGUNAN SARANA DAN PRASARANA KELURAHAN
PEKERJAAN :
SEMENISASI JALAN (22 M X 3,3 M X 0,15 M = 10,89 M3)
LOKASI :

JL. ABDUL SANI GANI, RT. 29, GANG AKBAR, KEL. SUNGAI KELEDANG, KEC. SAMARINDA SEBERANG
TAHUN ANGGARAN
2023



PEMERINTAH KOTA SAMARINDA

KEGIATAN

PEMBERDAYAAN KELURAHAN

SUB KEGIATAN

PEMBANGUNAN SARANA DAN PRASARANA KELURAHAN

PEKERJAAN

SEMENSI JALAN

22 M X 3.3 M X 0.16 M = 10.89 M³

LOKASI

Jl. Abdul Sani Ganj, RT.29,
Kelurahan Sungai Keledang,
Kecamatan Samarinda Seberang

MENGETAHUI / MENYETUJUI

LURAH SUNGAI KELEDANG

[Signature]

INDRA DI...
No. 1000001/2003/1004

TENAGA PENDAMPING

[Signature]

INDRA PERMANA...
No. 1000001/2003/1004

TIM PERENCANA

[Signature]

ANAYOD

KETERANGAN

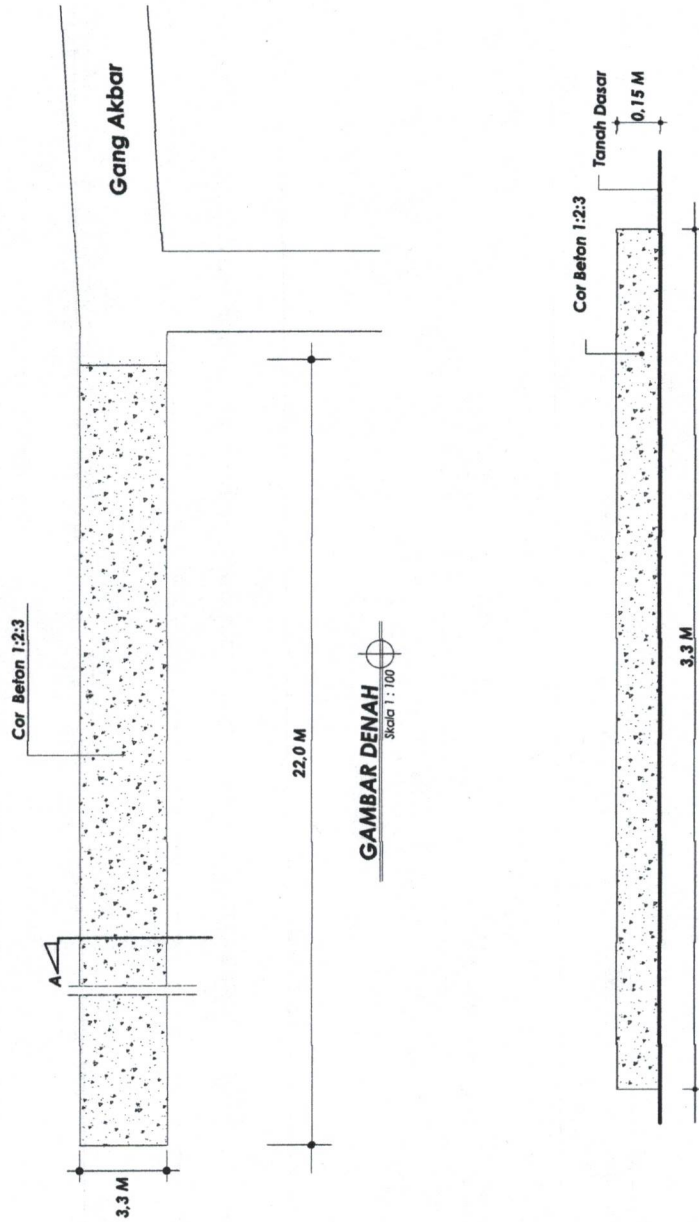



PEMERINTAH KOTA SAMARINDA

KEGIATAN

PEMBERDAYAAN KELUHAHAN

SUB KEGIATAN

PEMBANGUNAN SARANA DAN PRASARANA KELUHAHAN

PEKERJAAN

SEMENISASI JALAN
22 M X 3,3 M X 0,15 M = 10,89 M³

LOKASI

Jl. Abdul Sani Gani, RT.29,
Kelurahan Sungai Keledang,
Kecamatan Samarinda Seberang

MENGETAHUI / MENYERUJI

LURAH SUNGAI KELEDANG

LA IMADI, S.P.
No. Pokok Jabat: 200801104

TEMA / PENDAMPING

Indra Permata Rahmadani

TIM PERENCANA

Anwar

KETERANGAN



Jalan Bung Tomo

SDN. No. 16
Samarinda Seberang

Jalan Abdul Sani Gani

Lokasi Semenisasi Jalan
22mX3,3mX0,15m

Gang akbar

Gang Karet

Kantor Lurah
Sungai Keledang

DENAH LOKASI

Skala 1 : 100



PEMERINTAH KOTA SAMARINDA
PROGRAM PEMBANGUNAN DAN PEMBERDAYAAN MASYARAKAT
PRO BEBAYA
RENCANA ANGGARAN BIAYA (RAB)

KEGIATAN :
PEMBERDAYAAN KELURAHAN

SUB KEGIATAN :
PEMBANGUNAN SARANA DAN PRASARANA KELURAHAN

PEKERJAAN :
SEMENISASI JALAN
(20M X 3,5M X 0,15M = 10,5 M3)

LOKASI :
JL. ABDUL SANI GANI, RT.29, GG. AKBAR, KELURAHAN SUNGAI KELEDANG
KECAMATAN SAMARINDA SEBERANG

TAHUN ANGGARAN
2023

REKAPITULASI RAB PRO-BEBAYA 2023

BIDANG INFRASTRUKTUR

Kota : SAMARINDA

Kegiatan : Semenisasi Jalan

Kecamatan : SAMARINDA SEBERANG

Volume : 20 m X 3,5 m X 0,15 m = 10,5 M3

Kelurahan : SUNGAI KELEDANG

Lokasi : Jl. Abdul Sani Gani, RT.29, Gang Akbar

No.	URAIAN KEGIATAN	HARGA PEKERJAAN (Rp)
I	Semenisasi Jalan	19.443.550,00
	Sub Total	19.443.550,00
	Ppn 11%	2.138.790,50
	Jumlah	21.582.340,50
	Dibulatkan	21.582.000,00

Terbilang : "DUA PULUH SATU JUTA LIMA RATUS DELAPAN PULUH DUA RIBU RUPIAH"

**RENCANA ANGGARAN DAN BIAYA
BIDANG INFRASTRUKTUR**

Kota : SAMARINDA
Kecamatan : SAMARINDA SEBERANG
Kelurahan : SUNGAI KELEDANG

Kegiatan : Semenisasi Jalan
Volume : 20 m X 3,5 m X 0,15 m = 10,5 M3
Lokasi : Jl. Abdul Sani Gani, RT.29, Gang Akbar

NO	URAIAN	SATUAN	VOLUME	HARGA SATUAN	TOTAL BIAYA
				Rp	Rp
1	2	3	4	5	6 = 4x5
1	UPAH KERJA				
	1. Tukang	HOK	5,0	150.000,00	750.000,00
	2. Pekerja	HOK	23,0	110.000,00	2.530.000,00
				Jumlah 1	3.280.000,00
2	BAHAN				
	1. Semen 50 Kg	Sak	69,0	68.000,00	4.692.000,00
	2. Pasir Palu	M3	6,0	575.000,00	3.450.000,00
	3. Batu Pecah 2-3	M3	8,5	500.000,00	4.250.000,00
	4. Kayu Perancah	M3	0,24	2.200.000,00	528.000,00
	5. Paku Kayu 0,5"-1,5"	Kg	2,5	26.000,00	65.000,00
	6. Plastik Cor	M2	76,0	2.750,00	209.000,00
	7. Benang Bangunan	Bh	1,0	7.000,00	7.000,00
	8. Plywood 9mm	Lembar	2,5	126.500,00	316.250,00
	9. Obat Cor	Kg	0,8	165.000,00	135.300,00
				Jumlah 2	13.652.550,00
3	ALAT BANTU				
	1. Sewa Molen	Unit/Hari	2,0	350.000,00	700.000,00
	2. Arco	Bh	2,0	600.000,00	1.200.000,00
	3. Skop	Bh	3,0	65.000,00	195.000,00
	4. Cangkul + Gagang	Bh	1,0	125.000,00	125.000,00
	5. Keranjang Rotan	Bh	8,0	22.000,00	176.000,00
	6. Cetok	Bh	1,0	15.000,00	15.000,00
	7. Kasutan	Bh	1,0	15.000,00	15.000,00
	8. Gergaji	Bh	1,0	85.000,00	85.000,00
				Jumlah 3	2.511.000,00
				Total Biaya (1+2+3)	19.443.550,00



Mengetahui/menyetujui,
Lurah Sungai Keledang

RAHMADI, S.P.

Nip. 19820831 200502 1 004

Pendamping,

INDRA PERMANA R.



Ketua Tim Perencana,

ARSYAD



PEMERINTAH KOTA SAMARINDA
PROGRAM PEMBANGUNAN DAN PEMBERDAYAAN MASYARAKAT
PRO BEBAYA

GAMBAR RENCANA

KEGIATAN :
PEMBERDAYAAN KELURAHAN
SUB KEGIATAN :
PEMBANGUNAN SARANA DAN PRASARANA KELURAHAN
PEKERJAAN :
SEMENISASI JALAN (20 M X 3,5 M X 0,15 M = 10,5 M3)
LOKASI :

JL. ABDUL SANI GANI, RT. 29, GANG AKBAR, KEL. SUNGAI KELEDANG, KEC. SAMARINDA SEBERANG
TAHUN ANGGARAN
2023



PEMERINTAH KOTA SAMARINDA

KEGIATAN

PEMBERDAYAAN KELURAHAN

SUB KEGIATAN

PEMBANGUNAN SARANA DAN PRASARANA KELURAHAN

PEKERJAAN

SEMENSI GANG ARBAR
20 M X 3,5 M X 0,15 M = 10,5 M³

LOKASI

Jl. Abdul Sanjani, RT.29,
Kelurahan Sungai Keledang,
Kecamatan Samarinda Seberang

MENGETAHUI/ MENYETUJUI

LURAH SUNGAI KELEDANG

[Signature]
KARYAWAN, S.
No. 119/2021/2022/1/04

TENAGA PENDAMPING

[Signature]
Indra Firmansyah Samudani

TIM PERENCANA

[Signature]
Rajad

KETERANGAN

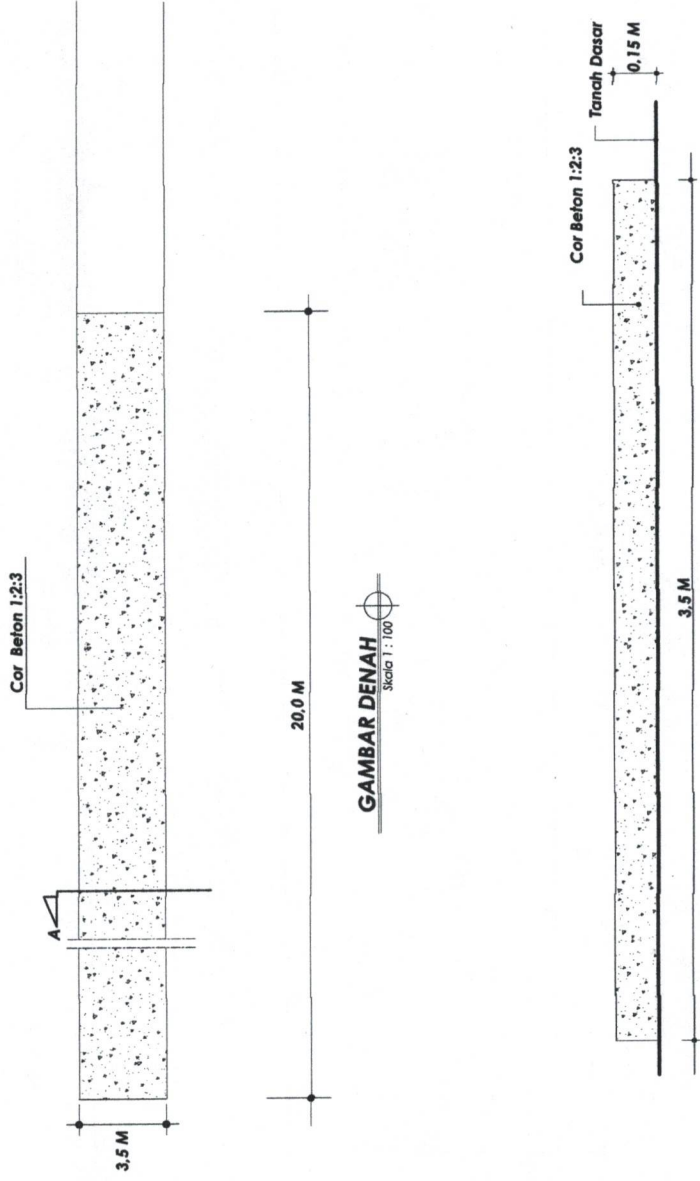

GAMBAR DENAH
Skala 1 : 100

DETAIL POTONGAN A
Skala 1 :



PEMERINTAH KOTA SAMARINDA

KEGIATAN

PEMBERDAYAAN KELURAHAN

SUB KEGIATAN

PEMBANGUNAN SARANA DAN PRASARANA KELURAHAN

PEKERJAAN

SEMENISASI JALAN
20 M X 3,5 M X 0,15 M = 10,5 M³

LOKASI

Jl. Abdul Sani Gani, RT.29,
Kelurahan Sungai Keledang,
Kecamatan Samarinda Seberang

MENGETAHUI/MENYETUJUI

LURAH SUNGAI KELEDANG

I.A. Nurhadi, S.P.
NIP. 32030120021001

TEMAGA PENDAMPING

Indra Permany Ramadani

TIM PELAKSANA

KETERANGAN



Jalan Bung Tomo

SDN. No. 16
Samarinda Seberang

Jalan Abdul Sani Gani

Lokasi Semenisasi Jalan
20mX3,5mX0,15m

Gang akbar

Gang Karet

Kantor Lurah
Sungai Keledang

DENAH LOKASI
Skala 1 : 100



PEMERINTAH KOTA SAMARINDA
PROGRAM PEMBANGUNAN DAN PEMBERDAYAAN MASYARAKAT
PRO BEBAYA
RENCANA ANGGARAN BIAYA (RAB)

KEGIATAN :
PEMBERDAYAAN KELURAHAN

SUB KEGIATAN :
PEMBANGUNAN SARANA DAN PRASARANA KELURAHAN

PEKERJAAN :
PEMBUATAN PONDASI JALAN/ LANTAI ULIN
(29M X 2M X 1M)

LOKASI :
JL. BUNG TOMO, RT. 30, GG. KELUARGA, KELURAHAN SUNGAI KELEDANG
KECAMATAN SAMARINDA SEBERANG

TAHUN ANGGARAN
2023

REKAPITULASI RAB PRO-BEBAYA 2023
BIDANG INFRASTRUKTUR

Kota : SAMARINDA
Kecamatan : SAMARINDA SEBERANG
Kelurahan : SUNGAI KELEDANG

Kegiatan : PEMBUATAN PONDASI JALAN/ LANTAI ULIN
Volume : 29M X 2M X 1M
Lokasi : Jl. Bung Tomo, RT 30, Gg. Keluarga

No.	URAIAN KEGIATAN	HARGA PEKERJAAN (Rp)
I	PEMBUATAN PONDASI JALAN/ LANTAI ULIN	53.692.700,00
	Sub Total	53.692.700,00
	Ppn 11%	5.906.197,00
	Jumlah	59.598.897,00
	Dibulatkan	59.598.000,00

Terbilang : "LIMA PULUH SEMBILAN JUTA LIMA RATUS SEMBILAN PULUH DELAPAN RIBU RUPIAH"

**RENCANA ANGGARAN DAN BIAYA
BIDANG INFRASTRUKTUR**

Kota : SAMARINDA
Kecamatan : SAMARINDA SEBERANG
Kelurahan : SUNGAI KELEDANG

Kegiatan : PEMBUATAN PONDASI JALAN/ LANTAI ULIN
Volume : 29M X 2M X 1M
Lokasi : Jl. Bung Tomo, RT 30, Gg. Keluarga

NO	URAIAN	SATUAN	VOLUME	HARGA SATUAN	TOTAL BIAYA
				Rp	Rp
1	2	3	4	5	6 = 4+5
1	UPAH KERJA				
	1. Tukang	HOK	20,0	150.000,00	3.000.000,00
	2. Pekerja	HOK	45,0	110.000,00	4.950.000,00
				Jumlah 1	7.950.000,00
2	BAHAN				
	1. Semen 50 Kg	Sak	104,0	68.000,00	7.072.000,00
	2. Pasir Mahakam	M3	19,0	198.000,00	3.762.000,00
	3. Batu Padas	M3	41,0	315.700,00	12.943.700,00
	4. Korol	M3	0,5	1.800.000,00	900.000,00
	4. Ulin 5/10x4m	M3	0,5	6.600.000,00	3.300.000,00
	5. Ulin 10/10x40m	M3	1,2	6.600.000,00	7.920.000,00
	6. Papan Ulin 2/20x4m	M3	1,2	6.600.000,00	7.986.000,00
	7. Baut 1/2 x 23cm	Bj	42,0	7.000,00	294.000,00
	8. Paku Ulin	Kg	5,0	22.000,00	110.000,00
				Jumlah 2	44.287.700,00
3	ALAT BANTU				
	1. Arco	Bh	2,0	600.000,00	1.200.000,00
	2. Skop	Bh	1,0	65.000,00	65.000,00
	3. Cangkul	Bh	1,0	75.000,00	75.000,00
	4. Cetok	Bh	1,0	15.000,00	15.000,00
	5. Kasutan	Bh	1,0	15.000,00	15.000,00
	6. Gergaji	Bh	1,0	85.000,00	85.000,00
				Jumlah 3	1.455.000,00
				Total Biaya (1+2+3)	53.692.700,00

Mengetahui/menyetujui,
Lurah Sungai Keledang



RAHMADI, S.P.
Nip. 19820831 200502 1 004

Pendamping,



INDRA PERMANA R.

Ketua Tim Perencana,



ARSYAD F.



PEMERINTAH KOTA SAMARINDA

**PROGRAM PEMBANGUNAN DAN PEMBERDAYAAN MASYARAKAT
PRO BEBAYA**

GAMBAR RENCANA

KEGIATAN :

PEMBERDAYAAN KELURAHAN

SUB KEGIATAN :

PEMBANGUNAN SARANA DAN PRASARANA KELURAHAN





PEKERJAAN :

PEMBUATAN PONDASI JALAN/ LANTAI ULIN (29mX2mX1 m)



LOKASI :

**JL. BUNG TOMO, RT. 30, GG KELUARGA KELURAHAN SUNGAI KELEDANG, KEC. SAMARINDA SEBERANG
TAHUN ANGGARAN**

2023

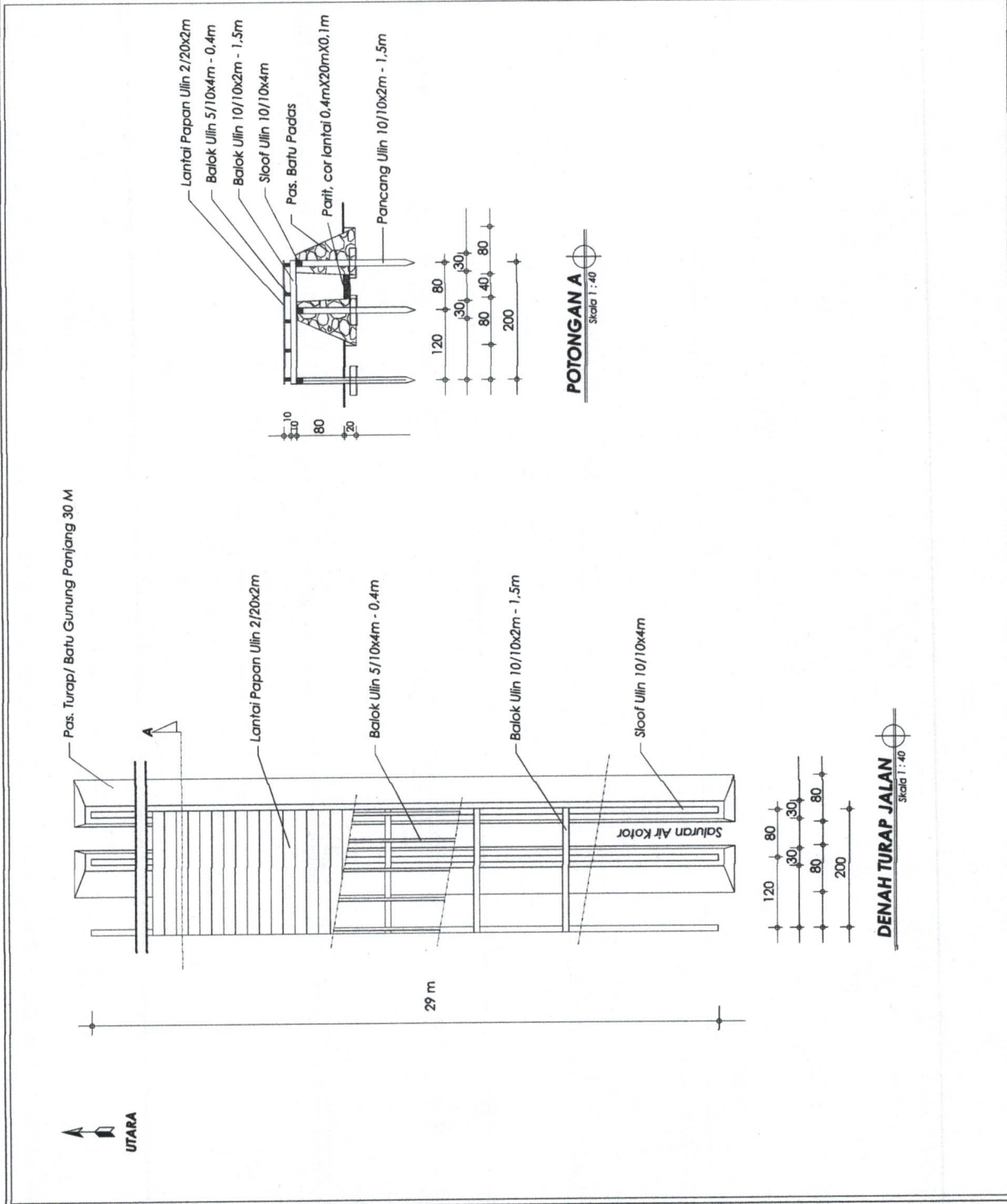
	PEMERINTAH KOTA SAMARINDA
KEGIATAN	PEMBERDAYAAN KEURAHAN
SUB KEGIATAN	PEMBANGUNAN SARANA DAN PRASARANA KEURAHAN
PEKERJAAN	PEMBUATAN PONDASI JALAN/LANTAI ULIN 29 M X 2 M X 1 M
LOKASI	JL. Bung Tomo, Rt.30, Gang Keluarga Kelurahan Sungai Kediang, Kecamatan Samarinda Seberang
MENGETAHUI / MENYETUJUI	 KAPALA DINAS PUP NIP. 197300812006031004
LURAH SUNGAI KEDANG	 TENAGA PENDAMPING
INDRA PERMANA SAMADANI	 TIM PERENCANA
KETERANGAN	

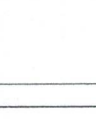

	PEMERINTAH KOTA SAMARINDA
KEGIATAN	PEMBERDAYAAN KELURAHAN
SUB KEGIATAN	PENBANGUNAN SARANA DAN PRASARANA KELURAHAN
PEKERJAAN	PEMBUATAN FONDASI JALAN/ LANTAI ULIN 29 M X 2 M X 1 M
LOKASI	Jl. Bung Tomo, RT.30, Gang Keluaraga, Kelurahan Sungai Keledang, Kecamatan Samatinda Seberang
MENGETAHUI/ MENYEBUHI	LURAH SUNGAI KELEDANG
	 <small>KELOMPOK 10 RT.30/ RW.001 No. 19 Januari 2020/1001</small>
TENAGA PENDAMPING	 Indira Permana Ramadani
TIM PEJABAT	 Kasyad
KETERANGAN	

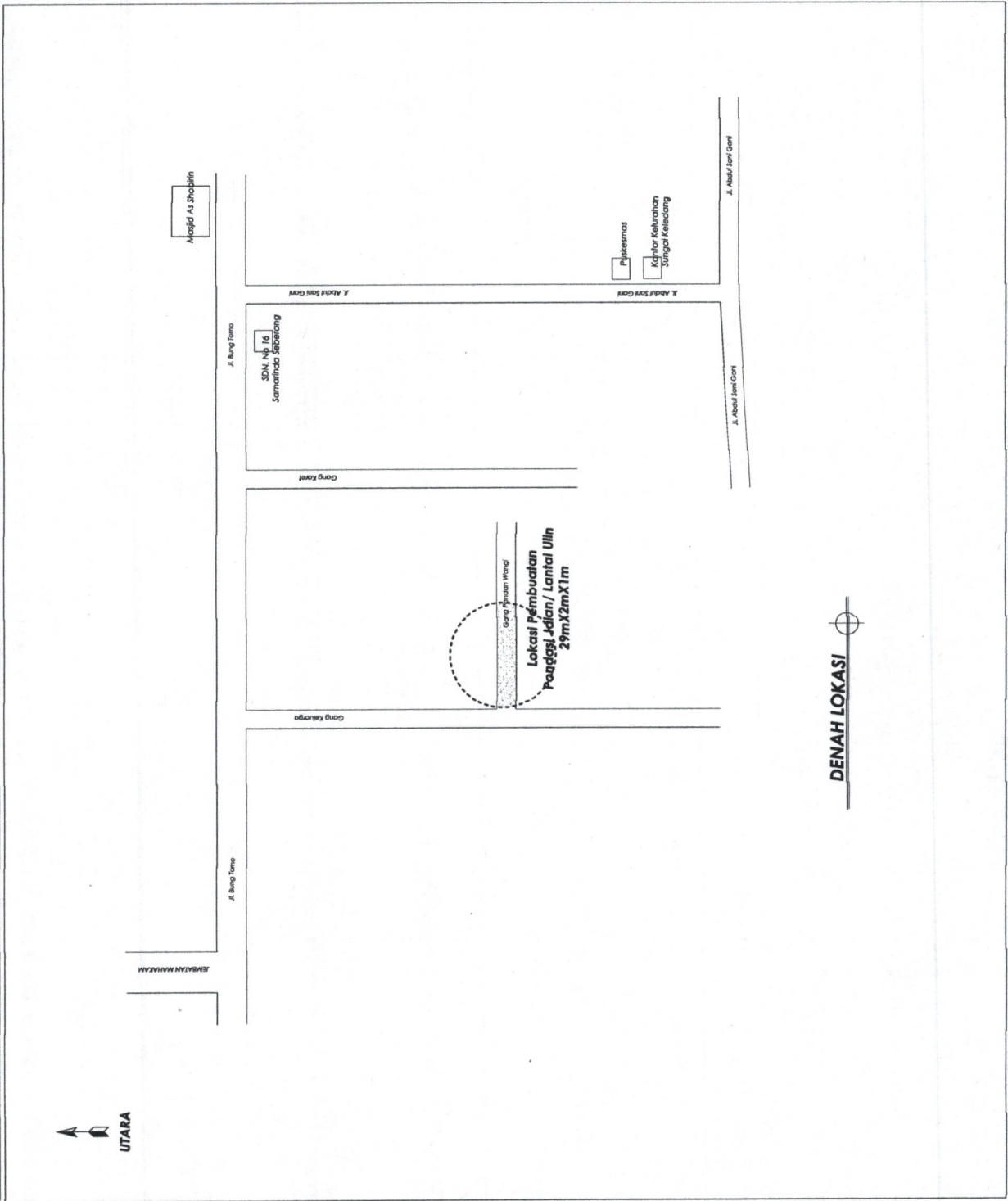



PEMERINTAH KOTA SAMARINDA
PROGRAM PEMBANGUNAN DAN PEMBERDAYAAN MASYARAKAT
PRO BEBAYA
RENCANA ANGGARAN BIAYA (RAB)

KEGIATAN :
PEMBERDAYAAN KELURAHAN

SUB KEGIATAN :
PEMBANGUNAN SARANA DAN PRASARANA KELURAHAN

PEKERJAAN :
SEMENISASI GANG
(77M X 2M X 0,12M = 18,48 M3)

LOKASI :
JL. BUNG TOMO, RT. 31, GANG SELAMAT, KELURAHAN SUNGAI KELEDANG
KECAMATAN SAMARINDA SEBERANG

TAHUN ANGGARAN
2023

REKAPITULASI RAB PRO-BEBAYA 2023**BIDANG INFRASTRUKTUR**

Kota : SAMARINDA
Kecamatan : SAMARINDA SEBERANG
Kelurahan : SUNGAI KELEDANG

Kegiatan : SEMENISASI GANG
Volume : 77 m X 2 m X 0,12 m = 18,48 M3
Lokasi : Jl. Bung Tomo, RT 31, Gg. Selamat

No.	URAIAN KEGIATAN	HARGA PEKERJAAN (Rp)
I	SEMENISASI GANG	34.162.800,00
	Sub Total	34.162.800,00
	Ppn 11%	3.757.908,00
	Jumlah	37.920.708,00
	Dibulatkan	37.921.000,00

Terbilang : "TIGA PULUH TUJUH JUTA SEMBILAN RATUS DUA PULUH SATU RIBU RUPIAH"

**RENCANA ANGGARAN DAN BIAYA
BIDANG INFRASTRUKTUR**

Kota : SAMARINDA
Kecamatan : SAMARINDA SEBERANG
Kelurahan : SUNGAI KELEDANG

Kegiatan : SEMENISASI GANG
Volume : 77 m X 2 m X 0,12 m = 18,48 M3
Lokasi : Jl. Bung Tomo, RT 31, Gg. Selamat

NO	URAIAN	SATUAN	VOLUME	HARGA SATUAN	TOTAL BIAYA
				Rp	Rp
1	2	3	4	5	6 = 4+5
1	UPAH KERJA				
	1. Tukang	HOK	6,0	150.000,00	900.000,00
	2. Pekerja	HOK	38,0	110.000,00	4.180.000,00
				Jumlah 1	5.080.000,00
2	BAHAN				
	1. Semen 50 Kg	Sak	121,00	68.000,00	8.228.000,00
	2. Pasir Palu	M3	10,50	575.000,00	6.037.500,00
	3. Batu Pecah 2-3	M3	15,00	500.000,00	7.500.000,00
	4. Kayu Perancah	M3	0,74	2.200.000,00	1.628.000,00
	5. Paku Kayu 0,5"-1,5"	Kg	7,50	26.000,00	195.000,00
	6. Plastik Cor	M2	173,00	2.750,00	475.750,00
	7. Benang Bangunan	Bh	2,00	7.000,00	14.000,00
	8. Plywood 9mm	Lembar	6,50	126.500,00	822.250,00
	9. Obat Cor	Kg	0,82	165.000,00	135.300,00
				Jumlah 2	25.035.800,00
3	ALAT BANTU				
	1. Sewa Molen	Unit/Hari	3,00	350.000,00	1.050.000,00
	2. Arco	Bh	4,00	600.000,00	2.400.000,00
	3. Skop	Bh	3,00	65.000,00	195.000,00
	4. Cangkul + Gagang	Bh	1,00	125.000,00	125.000,00
	5. Keranjang Rotan	Bh	6,00	22.000,00	132.000,00
	6. Cetok	Bh	2,00	15.000,00	30.000,00
	7. Kasutan	Bh	2,00	15.000,00	30.000,00
	8. Gergaji	Bh	1,00	85.000,00	85.000,00
				Jumlah 3	4.047.000,00
				Total Biaya (1+2+3)	34.162.800,00

Mengetahui/menyetujui,
Lurah Sungai Keledang

RAHMADI, S.P.
Nip. 19820831 200502 1 004

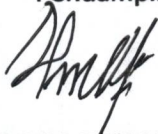
Pendamping,

INDRA PERMANA R.

Ketua Tim Perencana,

ARSYAD



PEMERINTAH KOTA SAMARINDA

**PROGRAM PEMBANGUNAN DAN PEMBERDAYAAN MASYARAKAT
PRO BEBAYA**

GAMBAR RENCANA

KEGIATAN :

PEMBERDAYAAN KELURAHAN

SUB KEGIATAN :

PEMBANGUNAN SARANA DAN PRASARANA KELURAHAN

PEKERJAAN :

SEMENISASI GANG (77 M X 2 M X 0,10 M = 18,48 M3)

LOKASI :

**L. BUNG TOMO, RT. 31, GANG SELAMAT, KEL. SUNGAI KELEDANG, KEC. SAMARINDA SEBERANG
TAHUN ANGGARAN
2023**



PEMERINTAH KOTA SAMARINDA

KEGIATAN

PEMBERIDAYAAN KELURAHAN

SUB KEGIATAN

PEMANGUNAN SARANA DAN PRASARANA KELURAHAN

PEKERJAAN

SEMENISASI JALAN
77 M X 2 M X 0,12 M = 18,48 M³

LOKASI

Jl. Bung Tomo, RT.31, Gang Selamat
Kelurahan Sungai Keledang,
Kecamatan Samarinda Seberang

MENGEHAJI / MENYENJUKI

URAH SUNGAI KELEDANG

K. A. W. K. S. I.
No. 120001200021001

TEMAGA PENDAMPING

Indra Permana Ramadani

TIM PEKERJANA

Anysad

KETERANGAN

UTARA

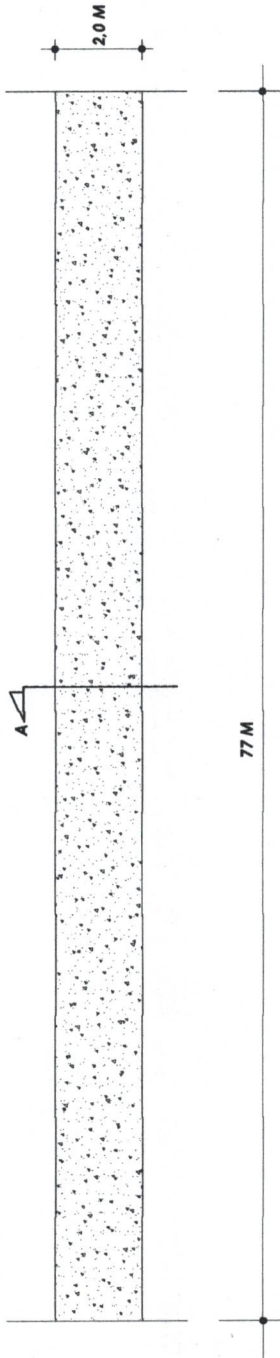

GAMBAR DENAH
Skala 1 : 100

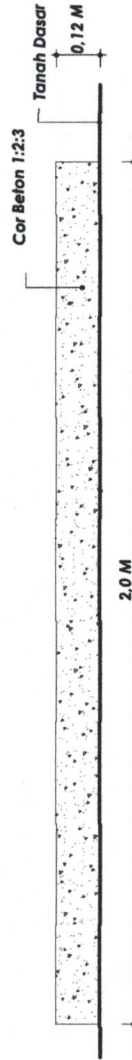

DETAIL POTONGAN A
Skala 1 : ...



JEMBATAN MANIKAM

J. Bung Tomo

J. Bung Tomo

Majelis As Shobrin

SDN. N. 16
Samarinda Seberang

Gang Selambar

Gang Kalayaga

Gang Kayri

J. Abdul Sori Ganti

J. Abdul Sori Ganti

J. Abdul Sori Ganti

J. Abdul Sori Ganti

Pajakemas

Kantor Kelurahan
Sungai Keledang



PEMERINTAH KOTA SAMARINDA

KEGIATAN

PEMBERDAYAAN KELURAHAN

SUB KEGIATAN

PEMANGUNAN SARANA DAN
PRASARANA KELURAHAN

PEKERJAAN

SEMENISASI JALAN
77 M X 2 M X 0,12 M = 18,48 M³

LOKASI

Jl. Bung Tomo, RT.31, Gang Selamat
Kelurahan Sungai Keledang,
Kecamatan Samarinda Seberang

MENGETAHUI/ MENYETUJUI

LURAH SUGAI KELEDANG

E. PRWADI, L.P.
No. 022081 220815 1 004

TANDA PUNDAMPING

Indra Permanto Samadani

TIM PEKERJANYA

Hidayat

KETERANGAN

DENAH LOKASI



PEMERINTAH KOTA SAMARINDA
PROGRAM PEMBANGUNAN DAN PEMBERDAYAAN MASYARAKAT
PRO BEBAYA
RENCANA ANGGARAN BIAYA (RAB)

KEGIATAN :
PEMBERDAYAAN KELURAHAN

SUB KEGIATAN :
PEMBANGUNAN SARANA DAN PRASARANA KELURAHAN

PEKERJAAN :
SEMENISASI JALAN
(18M X 2M X 0,12M = 4,32 M3)

LOKASI :
JL. BUNG TOMO, RT. 32, GANG 2, KELURAHAN SUNGAI KELEDANG
KECAMATAN SAMARINDA SEBERANG

TAHUN ANGGARAN
2023

REKAPITULASI RAB PRO-BEBAYA 2023**BIDANG INFRASTRUKTUR**

Kota : SAMARINDA

Kecamatan : SAMARINDA SEBERANG

Kelurahan : SUNGAI KELEDANG

Kegiatan : SEMENISASI JALAN

Volume : 18 m X 2 m X 0,12 m = 4,32 M3

Lokasi : Jl. Bung Tomo, RT.32, Gang 2

No.	URAIAN KEGIATAN	HARGA PEKERJAAN (Rp)
I	SEMENISASI JALAN	10.748.550,00
	Sub Total	10.748.550,00
	PPN 11%	1.182.340,50
	Jumlah	11.930.890,50
	Dibulatkan	11.931.000,00

Terbilang : "SEBELAS JUTA SEMBILAN RATUS TIGA PULUH SATU RIBU RUPIAH"

**RENCANA ANGGARAN DAN BIAYA
BIDANG INFRASTRUKTUR**

Kota : SAMARINDA
Kecamatan : SAMARINDA SEBERANG
Kelurahan : SUNGAI KELEDANG

Kegiatan : SEMENISASI JALAN
Volume : 18 m X 2 m X 0,12 m = 4,32 M3
Lokasi : Jl. Bung Tomo, RT.32, Gang 2

NO	URAIAN	SATUAN	VOLUME	HARGA SATUAN	TOTAL BIAYA
				Rp	Rp
1	2	3	4	5	6 = 4+5
1	UPAH KERJA				
	1. Tukang	HOK	3,0	150.000,00	450.000,00
	2. Pekerja	HOK	12,0	110.000,00	1.320.000,00
				Jumlah 1	1.770.000,00
2	BAHAN				
	1. Semen 50 Kg	Sak	30,0	68.000,00	2.040.000,00
	2. Pasir Palu	M3	2,5	575.000,00	1.437.500,00
	3. Batu Pecah 2-3	M3	3,5	500.000,00	1.750.000,00
	4. Kayu Perancah	M3	0,17	2.200.000,00	374.000,00
	5. Paku Kayu 0,5"-1,5"	Kg	2,0	26.000,00	52.000,00
	6. Plastik Cor	M2	41,0	2.750,00	112.750,00
	7. Benang Bangunan	Bh	2,0	7.000,00	14.000,00
	8. Plywood 9mm	Lembar	2,0	126.500,00	253.000,00
	9. Obat Cor	Kg	0,8	165.000,00	135.300,00
				Jumlah 2	6.168.550,00
3	ALAT BANTU				
	1. Sewa Molen	Unit/Hari	2,0	350.000,00	700.000,00
	2. Arco	Bh	2,0	600.000,00	1.200.000,00
	3. Skop	Bh	3,0	65.000,00	195.000,00
	4. Cangkul + Gagang	Bh	2,0	125.000,00	250.000,00
	5. Keranjang Rotan	Bh	10,0	22.000,00	220.000,00
	6. Cetok	Bh	2,0	15.000,00	30.000,00
	7. Kasutan	Bh	3,0	15.000,00	45.000,00
	8. Gergaji	Bh	2,0	85.000,00	170.000,00
				Jumlah 3	2.810.000,00
				Total Biaya (1+2+3)	10.748.550,00



Mengetahui/menyetujui,
Lurah Sungai Keledang

RAHMADI, S.P.

Nip. 19820831 200502 1 004

Pendamping,

INDRA PERMANA R.



Ketua Tim Perencana,

ARSYAD



PEMERINTAH KOTA SAMARINDA
PROGRAM PEMBANGUNAN DAN PEMBERDAYAAN MASYARAKAT
PRO BEBAYA

GAMBAR RENCANA

KEGIATAN :
PEMBERDAYAAN KELURAHAN
SUB KEGIATAN :
PEMBANGUNAN SARANA DAN PRASARANA KELURAHAN
PEKERJAAN :
SEMENISASI JALAN (18 M X 2 M X 0,12 M = 4,32 M3)

LOKASI :
JL. BUNG TOMO, RT. 32, GANG 2, KEL. SUNGAI KELEDANG, KEC. SAMARINDA SEBERANG
TAHUN ANGGARAN
2023



PEMERINTAH KOTA SAMARINDA

KEGIATAN

PEMBERDAYAAN KELURAHAN

SUB KEGIATAN

PEMBANGUNAN SABANA DAN PRASATANA KELURAHAN

PEKERJAAN

SEMENIASI JALAN
18 M X 2 M X 0,12 M = 4,32 M³

LOKASI

Jl. Bung Tomo, RT. 32, Gang 2,
Kelurahan Sungai Keledang,
Kecamatan Samarinda Seberang

MENGETAHUI, MENYETUJUI

LURAH SUNGAI KELEDANG

[Signature]
P. J. HIKADI, S.P.
No. 000001/2003/1.004

TENAGA PENDAMPING

[Signature]
Indra Permaha Naphtadani

TIM PERENCANA

[Signature]
Jaya



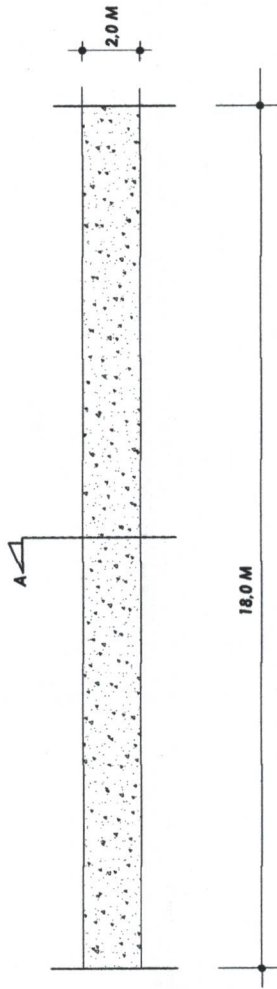

KETERANGAN



GAMBAR DENAH



DETAIL POTONGAN A-A

	PEMERINTAH KOTA SAMARINDA
KEGIATAN	
PEMBERDAYAAN KELURAHAN	
SUB KEGIATAN	
PEMBANGUNAN SARANA DAN PRASARANA KELURAHAN	
PEKERJAAN	
SEMENISASI JALAN	18 M X 2 M X 0,12 M = 4,32 M3
LOKASI	
	Jl. Bung Tomo, RT. 32, Gang 2, Kelurahan Sungai Keledang, Kecamatan Samarinda Seberang
MENGETAHUI/ MENYETUJUI	
LURAH SUNGAI KELEDANG	
	SAMARINDA, 10 MARET 2023
TENAGA PENDAMPING	
	Indra Permata Ramadani
TIU PEMBERICHA	
	Asyad
KETERANGAN	

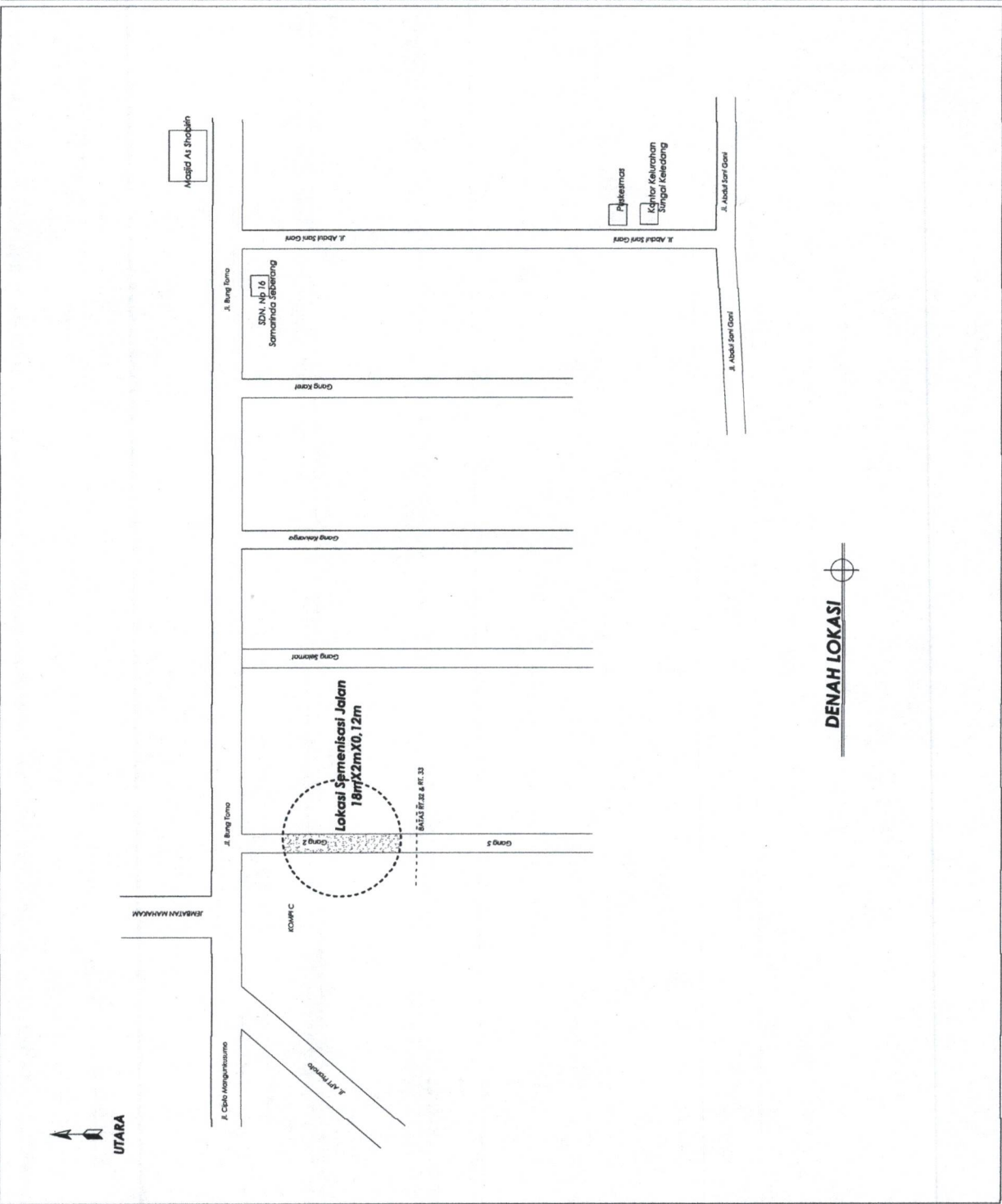

DENAH LOKASI





PEMERINTAH KOTA SAMARINDA
PROGRAM PEMBANGUNAN DAN PEMBERDAYAAN MASYARAKAT
PRO BEBAYA
RENCANA ANGGARAN BIAYA (RAB)

KEGIATAN :
PEMBERDAYAAN KELURAHAN

SUB KEGIATAN :
PEMBANGUNAN SARANA DAN PRASARANA KELURAHAN

PEKERJAAN :
SEMENISASI JALAN
(26M X 2M X 0,12M = 6,24 M3)

LOKASI :
JL. BUNG TOMO, RT. 33, GANG 5, KELURAHAN SUNGAI KELEDANG
KECAMATAN SAMARINDA SEBERANG

TAHUN ANGGARAN
2023

REKAPITULASI RAB PRO-BEBAYA 2023**BIDANG INFRASTRUKTUR**

Kota : SAMARINDA
Kecamatan : SAMARINDA SEBERANG
Kelurahan : SUNGAI KELEDANG

Kegiatan : SEMENISASI JALAN
Volume : 26 m X 2 m X 0,12 m = 6,24 M3
Lokasi : Jl. Bung Tomo, RT 33, Gang 5

No.	URAIAN KEGIATAN	HARGA PEKERJAAN (Rp)
I	SEMENISASI JALAN	13.340.550,00
	Sub Total	13.340.550,00
	Ppn 11%	1.467.460,50
	Jumlah	14.808.010,50
	Dibulatkan	14.808.000,00

Terbilang : "EMPAT BELAS JUTA DELAPAN RATUS DELAPAN RIBU RUPIAH"

**RENCANA ANGGARAN DAN BIAYA
BIDANG INFRASTRUKTUR**

Kota : SAMARINDA
Kecamatan : SAMARINDA SEBERANG
Kelurahan : SUNGAI KELEDANG

Kegiatan : SEMENISASI JALAN
Volume : 26 m X 2 m X 0,12 m = 6,24 M3
Lokasi : Jl. Bung Tomo, RT 33, Gang 5

NO	URAIAN	SATUAN	VOLUME	HARGA SATUAN	TOTAL BIAYA
				Rp	Rp
1	2	3	4	5	6 = 4+5
1	UPAH KERJA				
	1. Tukang	HOK	4,0	150.000,00	600.000,00
	2. Pekerja	HOK	15,0	110.000,00	1.650.000,00
				Jumlah 1	2.250.000,00
2	BAHAN				
	1. Semen 50 kg	Sak	41,0	68.000,00	2.788.000,00
	2. Pasir Palu	M3	4,00	575.000,00	2.300.000,00
	3. Batu Pecah 2-3	M3	5,00	500.000,00	2.500.000,00
	4. Kayu Perancah	M3	0,26	2.200.000,00	572.000,00
	5. Paku Kayu 0,5"-1,5"	Kg	2,5	26.000,00	65.000,00
	6. Plastik Cor	M2	60,0	2.750,00	165.000,00
	7. Benang Bangunan	Bh	1,0	7.000,00	7.000,00
	8. Plywood 9mm	Lembar	2,5	126.500,00	316.250,00
	9. Obat Cor	Kg	0,82	165.000,00	135.300,00
				Jumlah 2	8.848.550,00
3	ALAT BANTU				
	1. Sewa Molen	Unit/Hari	1,0	350.000,00	350.000,00
	2. Arco	Bh	2,0	600.000,00	1.200.000,00
	3. Skop	Bh	3,0	65.000,00	195.000,00
	4. Cangkul + Gagang	Bh	2,0	125.000,00	250.000,00
	5. Keranjang Rotan	Bh	6,0	22.000,00	132.000,00
	6. Cetok	Bh	1,0	15.000,00	15.000,00
	7. Kasutan	Bh	1,0	15.000,00	15.000,00
	8. Gergaji	Bh	1,0	85.000,00	85.000,00
				Jumlah 3	2.242.000,00
				Total Biaya (1+2+3)	13.340.550,00

Mengetahui/menyetujui,
Lurah Sungai Keledang



RAHMADI, S.P.
Nip. 19820831 200502 1 004

Pendamping,

INDRA PERMANA R.

Ketua Tim Perencana,

ABSYAD





PEMERINTAH KOTA SAMARINDA

PROGRAM PEMBANGUNAN DAN PEMBERDAYAAN MASYARAKAT

PRO BEBAYA

GAMBAR RENCANA

KEGIATAN :

PEMBERDAYAAN KELURAHAN

SUB KEGIATAN :

PEMBANGUNAN SARANA DAN PRASARANA KELURAHAN

PEKERJAAN :

SEMENISASI JALAN (26 M X 2 M X 0,12 M = 6,24 M3)

LOKASI :

**JL. BUNG TOMO, RT. 33, GANG 5, KEL. SUNGAI KELEDANG, KEC. SAMARINDA SEBERANG
TAHUN ANGGARAN**

2023

UTARA



PEMERINTAH KOTA SAMARINDA

KEBANGSAAN

PERBERDAYAAN KELURAHAN

SUB KEGIATAN

PMBANGUNAN SARANA DAN PRASARANA KELURAHAN

PEREJAJAN

SEMENISASI JALAN
26 M X 2 M X 0,12 M = 6,24 M³

LOKASI

Jl. Bung Tomo, Gang 5, RT. 33
Kelurahan Sungai Keledang,
Kecamatan Samarinda Seberang

MENGETAHUI / MENYERUJI

LURAH SUNGAI KELEDANG

[Signature]
SUNGGI, S.P.
No. 170/2008/1004

TENAGA PENDAMPING

[Signature]
Indra Permata Jemadani

TIM PENGACARA

[Signature]
Muyad



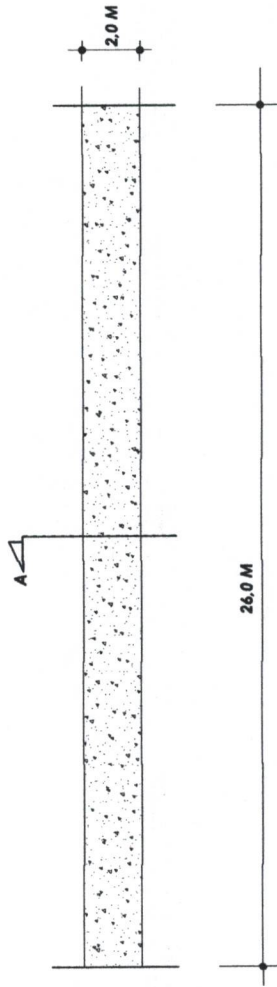

KETEBANGAN

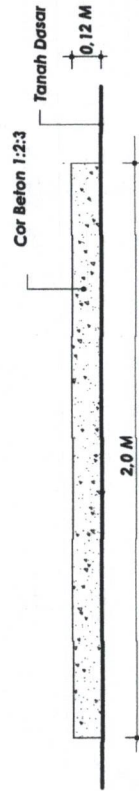

GAMBAR DENAH



DETAIL POTONGAN A-A

 PEMERINTAH KOTA SAMARINDA
KEGIATAN PEMBERDAYAAN KELURAHAN
SUB KEGIATAN PEMBANGUNAN SABANA DAN PRASARANA KELURAHAN
PEREJEJAN SEMENISASI JALAN 24 M X 2 M X 0,12 M = 6,24 M3
LOKASI Jl. Bung Tomo, Gang 5, RT. 33 Kelurahan Sungai Keledang, Kecamatan Samarinda Seberang
MENGEJAHIL / MENYERUHI LURAH SUNGAI KELEDANG
 KELOMPOK DI Tempat: Sabtu, 10 Mei 2024
TENAGA PENDAMPING  Fitria Permata Komalasari
TIM PENGUKUHAN  Arifad
KETERANGAN

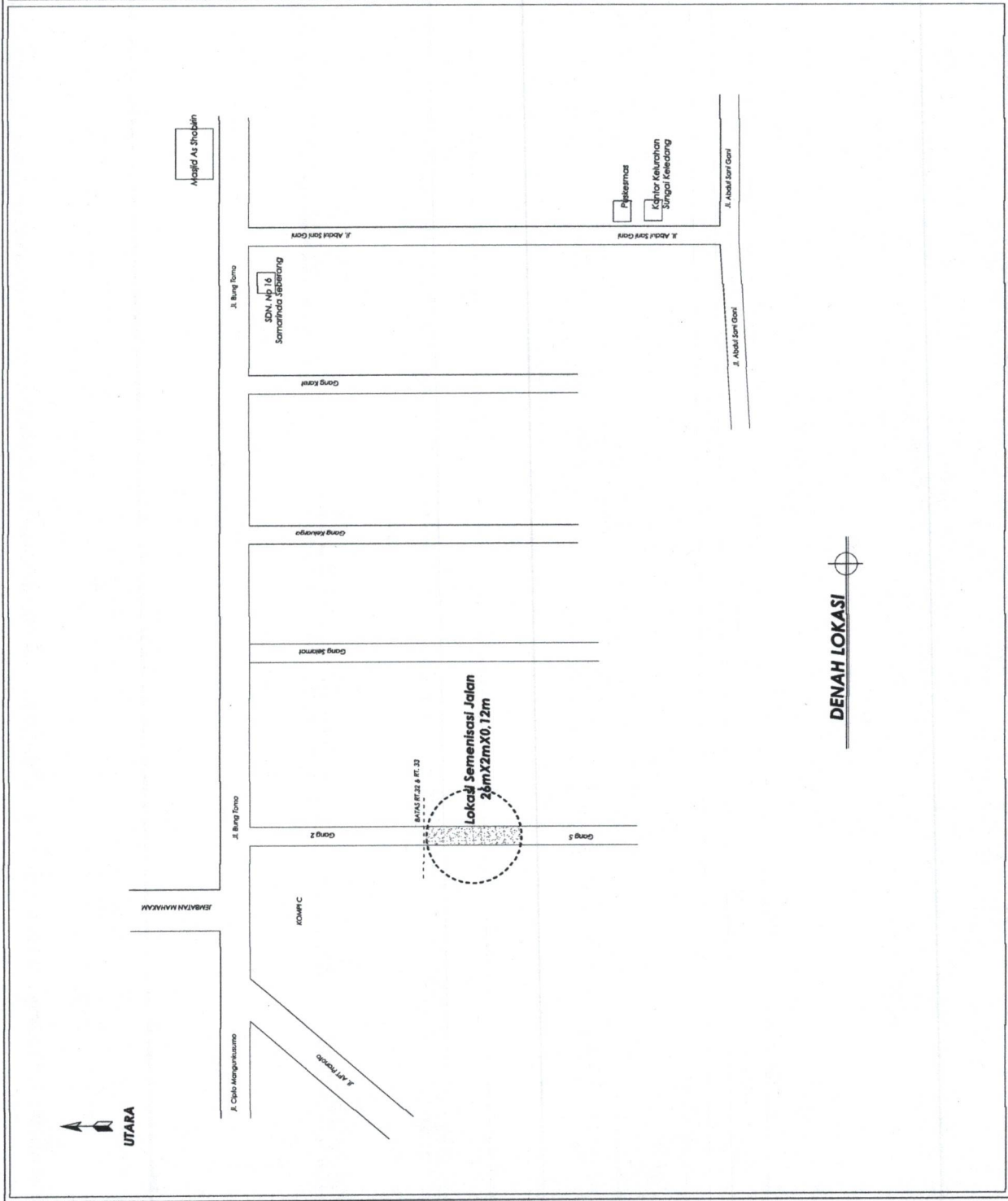



PEMERINTAH KOTA SAMARINDA
PROGRAM PEMBANGUNAN DAN PEMBERDAYAAN MASYARAKAT
PRO BEBAYA
RENCANA ANGGARAN BIAYA (RAB)

KEGIATAN :
PEMBERDAYAAN KELURAHAN

SUB KEGIATAN :
PEMBANGUNAN SARANA DAN PRASARANA KELURAHAN

PEKERJAAN :
SEMENISASI JALAN
(21M X 3M X 0,15M = 9,45 M3)

LOKASI :
JL. APT. PRANOTO, RT. 34, BLOK F, KOMPI C, KELURAHAN SUNGAI KELEDANG
KECAMATAN SAMARINDA SEBERANG

TAHUN ANGGARAN
2023

REKAPITULASI RAB PRO-BEBAYA 2023**BIDANG INFRASTRUKTUR**

Kota : SAMARINDA

Kegiatan : SEMENISASI JALAN

Kecamatan : SAMARINDA SEBERANG

Volume : 21 m X 3 m X 0,15 m = 9,45 M3

Kelurahan : SUNGAI KELEDANG

Lokasi : Jl. APT. Pranoto, RT.34, blok F, Kompi C

No.	URAIAN KEGIATAN	HARGA PEKERJAAN (Rp)
I	SEMENISASI JALAN	18.333.220,00
	Sub Total	18.333.220,00
	PPN 11%	2.016.654,20
	Jumlah	20.349.874,20
	Dibulatkan	20.350.000,00

Terbilang : "DUA PULUH JUTA TIGA RATUS LIMA PULUH RIBU RUPIAH"

**RENCANA ANGGARAN DAN BIAYA
BIDANG INFRASTRUKTUR**

Kota : SAMARINDA
Kecamatan : SAMARINDA SEBERANG
Kelurahan : SUNGAI KELEDANG

Kegiatan : SEMENISASI JALAN
Volume : 21 m X 3 m X 0,15 m = 9,45 M3
Lokasi : Jl. APT. Pranoto, RT.34, blok F, Kompi C

NO	URAIAN	SATUAN	VOLUME	HARGA SATUAN	TOTAL BIAYA
				Rp	Rp
1	2	3	4	5	6 = 4+5
1	UPAH KERJA				
	1. Tukang	HOK	4,0	150.000,00	600.000,00
	2. Pekerja	HOK	20,0	110.000,00	2.200.000,00
				Jumlah 1	2.800.000,00
2	BAHAN				
	1. Semen 50Kg	Sak	62,00	68.000,00	4.216.000,00
	2. Pasir Palu	M3	5,50	575.000,00	3.162.500,00
	3. Batu Pecah 2-3	M3	8,00	500.000,00	4.000.000,00
	4. Kayu Perancah	M3	0,25	2.200.000,00	550.000,00
	5. Paku Kayu 0,5"-1,5"	Kg	2,50	26.000,00	65.000,00
	6. Plastik Cor	M2	71,00	2.750,00	195.250,00
	7. Plywood 9mm	Lembar	3,00	126.500,00	379.500,00
	8. Obat Cor	Kg	0,82	165.000,00	134.970,00
				Jumlah 2	12.703.220,00
3	ALAT BANTU				
	1. Sewa Molen	Unit/Hari	2,0	350.000,00	700.000,00
	2. Arco	Bh	3,0	600.000,00	1.800.000,00
	3. Skop	Bh	1,0	65.000,00	65.000,00
	4. Cangkul + Gagang	Bh	1,0	125.000,00	125.000,00
	5. Keranjang Rotan	Bh	5,0	22.000,00	110.000,00
	6. Cetok	Bh	1,0	15.000,00	15.000,00
	7. Kasutan	Bh	1,0	15.000,00	15.000,00
	8. Gergaji	Bh		85.000,00	-
				Jumlah 3	2.830.000,00
				Total Biaya (1+2+3)	18.333.220,00

Mengetahui/menyetujui,
Lurah Sungai Keledang



RAHMADI, S.P.
Nip. 19820831 200502 1 004

Pendamping,

INDRA PERMANA R.

Ketua Tim Perencana,

ARSYAD





PEMERINTAH KOTA SAMARINDA

PROGRAM PEMBANGUNAN DAN PEMBERDAYAAN MASYARAKAT

PRO BEBAYA

GAMBAR RENCANA

KEGIATAN :

PEMBERDAYAAN KELURAHAN

SUB KEGIATAN :

PEMBANGUNAN SARANA DAN PRASARANA KELURAHAN

PEKERJAAN :

SEMENISASI JALAN (21 M X 3 M X 0,15MM = 9,45 M3)

LOKASI :

JL. APT PRANOTO, RT.34, BLOK F, KOMPI C, KEL. SUNGAI KELEDANG, KEC. SMD SEBERANG

TAHUN ANGGARAN

2023



PEMERINTAH KOTA SAMARINDA

KEGIATAN

PEMBERDAYAAN KELURAHAN

SUB KEGIATAN

PEMBANGUNAN SARANA DAN PRASARANA KELURAHAN

PEKERJAAN

SEMENIRASASI JALAN
21 M X 3.0 M X 0.15 M = 9.45 M³

LOKASI

Jl. APT Pranoto, RT. 34, Blok F
Kelurahan Sungai Kaledang,
Kecamatan Samarinda Seberang

MENGETAHUI/ MENYERUJI

LURAH SUNGAI KEBELANG

[Signature]
R. S. S. I.
No. 20092 1 004

TENAGA PENDAMPING

[Signature]
Indra Hermans Ramadani

TIM PERENCANA

[Signature]
Jusyad

KETERANGAN



Cor Beton 1:3:5

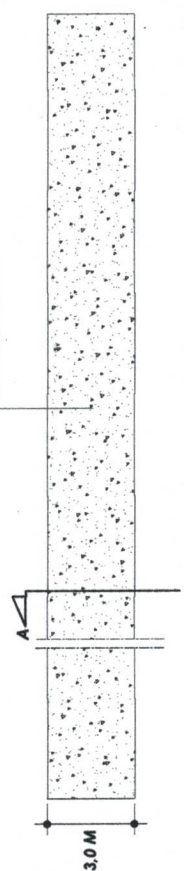

21.0 M

GAMBAR DENAH

Skala 1 : 100

Cor Beton 1:2:3

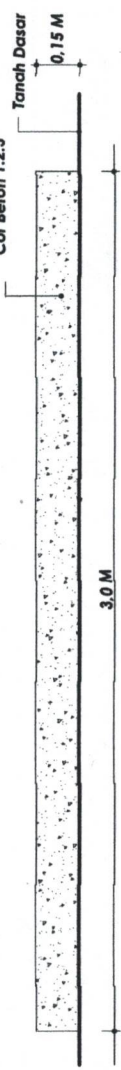

3.0 M

DETAIL POTONGAN A

Skala 1 : 10



PEMERINTAH KOTA SAMARINDA

KEGIATAN

PEMBERDAYAAN KELURAHAN

SUB KEGIATAN

PEMBANGUNAN SARANA DAN PRASARANA KELURAHAN

PEKERJAAN

SEMENISASI JALAN
21 M X 3,0 M X 0,15 M = 9,45 M³

LOKASI

Jl. APT Pranoto, RT. 34, Blok F
Kelurahan Junggal, Kecamatan
Kecamatan Samarinda Seberang

MENGETAHUI/ MENYETUJUI

LURAH SUNGAI KELBANG

[Signature]
S. HADI, S.P
No. NIP. 196301 200201 1 004

TENAGA PENDAMPING

[Signature]
Indra Permadi (Korpsadani)

TIM PENGACARA

[Signature]
Wisyad

KETERANGAN

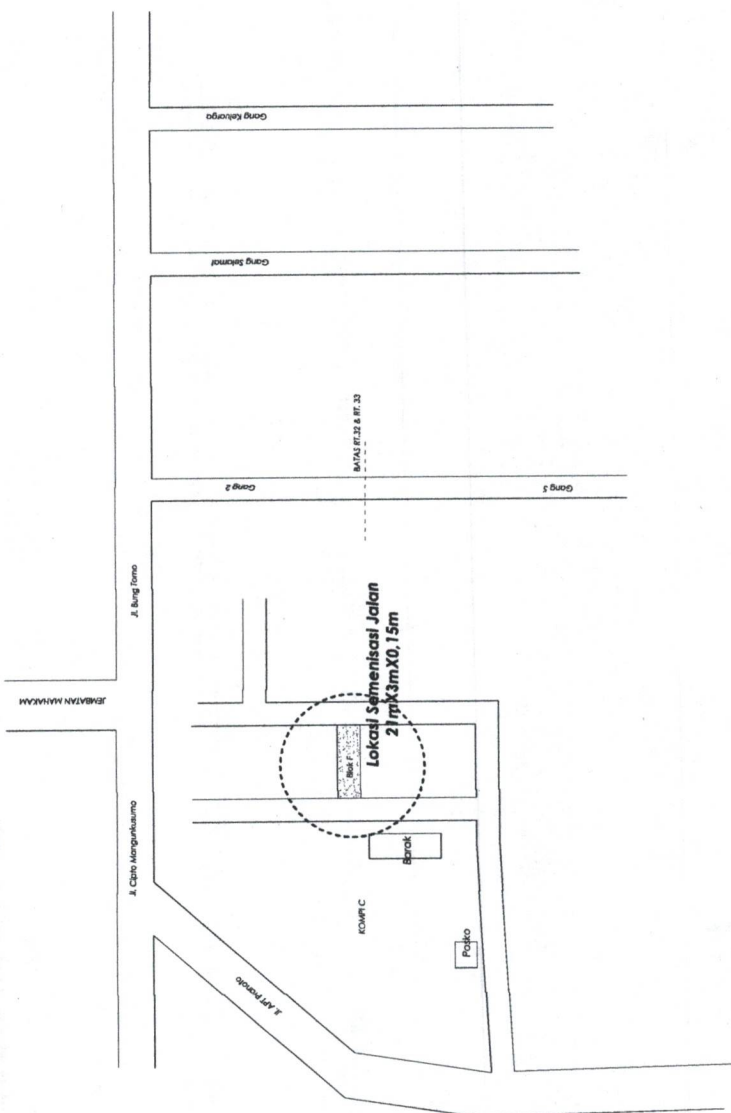

DENAH LOKASI



PEMERINTAH KOTA SAMARINDA
PROGRAM PEMBANGUNAN DAN PEMBERDAYAAN MASYARAKAT
PRO BEBAYA
RENCANA ANGGARAN BIAYA (RAB)

KEGIATAN :
PEMBERDAYAAN KELURAHAN

SUB KEGIATAN :
PEMBANGUNAN SARANA DAN PRASARANA KELURAHAN

PEKERJAAN :
SEMENISASI JALAN
(64M X 3M X 0,15M = 28,8 M3)

LOKASI :
JL. APT. PRANOTO, RT. 35, ASRAMA KOMPI C, KELURAHAN SUNGAI KELEDANG
KECAMATAN SAMARINDA SEBERANG

TAHUN ANGGARAN
2023

REKAPITULASI RAB PRO-BEBAYA 2023**BIDANG INFRASTRUKTUR**

Kota : SAMARINDA

Kegiatan : SEMENISASI JALAN

Kecamatan : SAMARINDA SEBERANG

Volume : 64 m X 3 m X 0,15 m = 28,8 M3

Kelurahan : SUNGAI KELEDANG

Lokasi : Jl. APT. Pranoto, RT 35, Asrama Kompi C

No.	URAIAN KEGIATAN	HARGA PEKERJAAN (Rp)
I	SEMENISASI JALAN	52.520.550,00
	Sub Total	52.520.550,00
	PPN 11%	5.777.260,50
	Jumlah	58.297.810,50
	Dibulatkan	58.298.000,00

Terbilang : "LIMA PULUH DELAPAN JUTA DUA RATUS SEMBILAN PULUH DELAPAN RIBU RUPIAH"

**RENCANA ANGGARAN DAN BIAYA
BIDANG INFRASTRUKTUR**

Kota : SAMARINDA
Kecamatan : SAMARINDA SEBERANG
Kelurahan : SUNGAI KELEDANG

Kegiatan : SEMENISASI JALAN
Volume : 64 m X 3 m X 0,15 m = 28,8 M3
Lokasi : Jl. APT. Pranoto, RT 35, Asrama Kompil C

NO	URAIAN	SATUAN	VOLUME	HARGA SATUAN	TOTAL BIAYA
				Rp	Rp
1	2	3	4	5	6 = 4x5
1	UPAH KERJA				
	1. Tukang	HOK	14,0	150.000,00	2.100.000,00
	2. Pekerja	HOK	61,0	110.000,00	6.710.000,00
				Jumlah 1	8.810.000,00
2	BAHAN				
	1. Semen 50Kg	Sak	188,0	68.000,00	12.784.000,00
	2. Pasir Palu	M3	16,5	575.000,00	9.487.500,00
	3. Batu Pecah 2-3	M3	23,0	500.000,00	11.500.000,00
	4. Kayu Perancah	M3	0,77	2.200.000,00	1.694.000,00
	5. Paku Kayu 0,5"-1,5"	Kg	8,5	26.000,00	221.000,00
	6. Plastik Cor	M2	211,0	2.750,00	580.250,00
	7. Benang Bangunan	Bh	5,0	7.000,00	35.000,00
	8. Plywood 9mm	Lembar	7,0	126.500,00	885.500,00
	9. Obat Cor	Kg	0,8	165.000,00	135.300,00
				Jumlah 2	37.322.550,00
3	ALAT BANTU				
	1. Sewa Molen	Unit/Hari	4,0	350.000,00	1.400.000,00
	2. Arco	Bh	6,0	600.000,00	3.600.000,00
	3. Skop	Bh	4,0	65.000,00	260.000,00
	4. Cangkul + Gagang	Bh	4,0	125.000,00	500.000,00
	5. Keranjang Rotan	Bh	14,0	22.000,00	308.000,00
	6. Cetok	Bh	5,0	15.000,00	75.000,00
	7. Kasutan	Bh	5,0	15.000,00	75.000,00
	8. Gergaji	Bh	2,0	85.000,00	170.000,00
				Jumlah 3	6.388.000,00
				Total Biaya (1+2+3)	52.520.550,00

Mengetahui/menyetujui,
Lurah Sungai Keledang



RAHMADI, S.P.
Nip. 19820831 200502 1 004

Pendamping,



INDRA PERMANA R.

Ketua Tim Perencana,



ARSYAD





PEMERINTAH KOTA SAMARINDA

**PROGRAM PEMBANGUNAN DAN PEMBERDAYAAN MASYARAKAT
PRO BEBAYA**

GAMBAR RENCANA

KEGIATAN :

PEMBERDAYAAN KELURAHAN

SUB KEGIATAN :

PEMBANGUNAN SARANA DAN PRASARANA KELURAHAN

PEKERJAAN :

SEMENISASI JALAN (64 M X 3 M X 0,15 M = 28,8 M3)

LOKASI :

**JL. APT. PRANOTO, RT.35, ASRAMA KOMPI C, KEL. SUNGAI KELEDANG, KEC. SAMARINDA SEBERANG
TAHUN ANGGARAN**

2023



PEMERINTAH KOTA SAMARINDA

KEGIATAN

PERBERDAYAAN KELURAHAN

SUB KEGIATAN

PEMBANGUNAN SABANA DAN PRASARANA KELURAHAN

PEKERJAAN

SEMBUNGAN JALAN
64 M X 3,0 M X 0,15 M = 28,8 M³

LOKASI

Jl. APT Pranoto, RT. 35, Asrama Kompi
Kelurahan Sungai Kesedang,
Kecamatan Samarinda Seberang

MENGETAHUI/ MENYETUJUI

LURAH SUNGAI KESELANG

SURYA WIDHI, S.P.
No. Ners. 000001/2008/1/004

TEMA/ PENDAMPING

Indira Permata Riyadani

TIM PELAKSANA

KETEBANGAN



Cor Beton 1:3:5

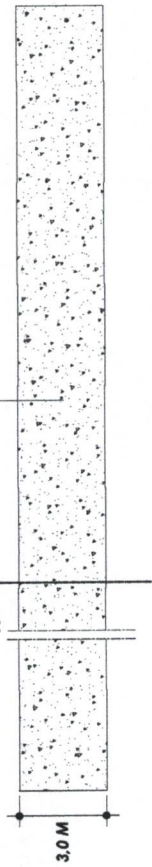

64,0 M

GAMBAR DENAH

Skala 1 : 100



Cor Beton 1:2:3

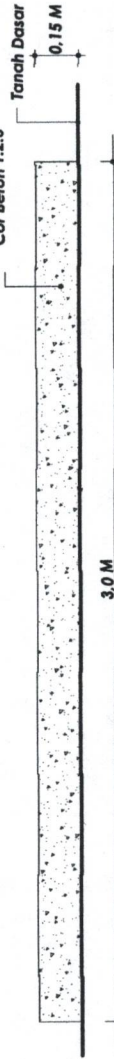

3,0 M

DETAIL POTONGAN A

Skala 1 : 100





PEMERINTAH KOTA SAMARINDA

KEGIATAN

PEMBERDAYAAN KELURAHAN

SUB KEGIATAN

PEMBANGUNAN SARANA DAN PRASARANA KELURAHAN

PEKERJAAN

SEMENISASI JALAN
44 M X 3,0 M X 0,15 M = 28,8 M³

LOKASI

J. APT Pramito, RT. 35, Arama Kempli
Kelurahan Jungai, Kecamatan
Kecamatan Samarinda Seberang

MENGETAHUI/MENYETUJUI

LURAH SUNGAI KEBERANG

[Signature]
S. HAJAJADI, S.P.
No. 11/2009/2009/21/004

TENAGA PENDAMPING

[Signature]
Indah Permata Ramadani

TIM PERENCANA

[Signature]
Rusyad

KETERANGAN

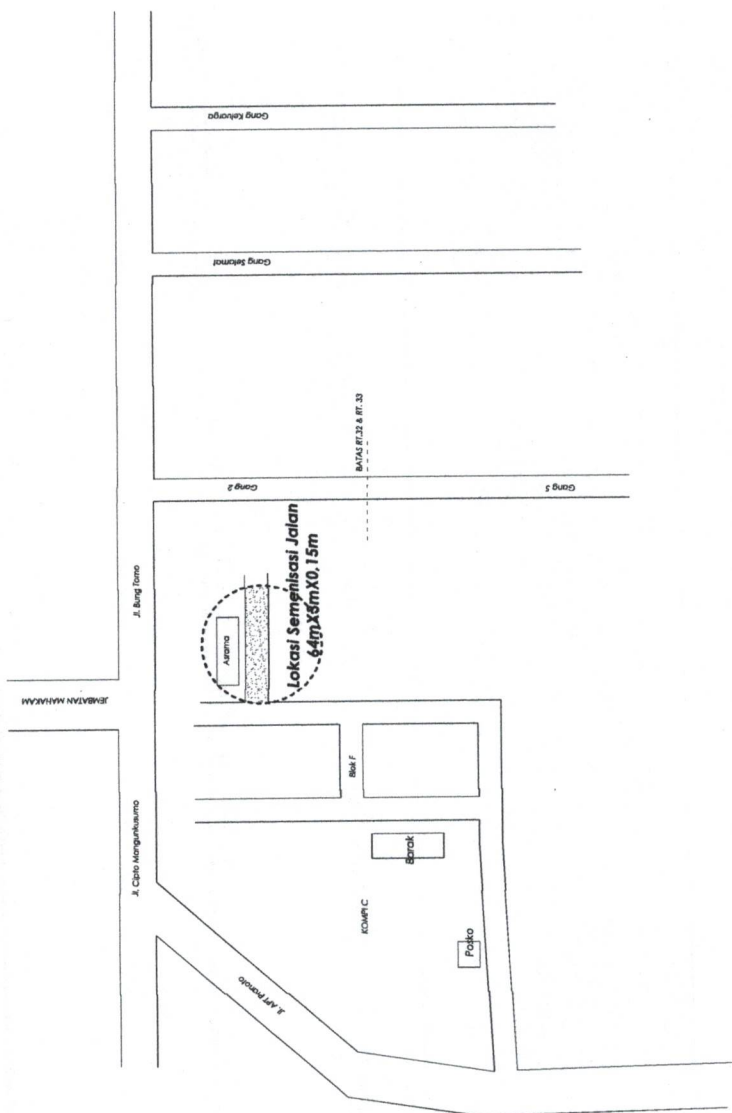

DENAH LOKASI



PEMERINTAH KOTA SAMARINDA
PROGRAM PEMBANGUNAN DAN PEMBERDAYAAN MASYARAKAT
PRO BEBAYA
RENCANA ANGGARAN BIAYA (RAB)

KEGIATAN :
PEMBERDAYAAN KELURAHAN

SUB KEGIATAN :
PEMBANGUNAN SARANA DAN PRASARANA KELURAHAN

PEKERJAAN :
PEMBUATAN KOLOM Ø40Cm & BALOK 25/40 Cm (LANTAI 2)

LOKASI :
JL. APT PRANOTO, RT.36, PERUM BPB, BLOK D, MUSHALLA AL IKHLASH
KEL. SUNGAI KELEDANG, KEC. SAMARINDA SEBERANG

TAHUN ANGGARAN
2023

REKAPITULASI RAB PRO-BEBAYA 2023**BIDANG INFRASTRUKTUR**

Kota : SAMARINDA

Kecamatan : SAMARINDA SEBERANG

Kelurahan : SUNGAI KELEDANG

Kegiatan : PEMBUATAN KOLOM & BALOK Lt.2

Volume : BALOK 25/40 cm, KOLOM Ø 40 cm

Lokasi : Jl. APT PRANOTO, RT.36, PERUM BPB

No.	URAIAN KEGIATAN	HARGA PEKERJAAN (Rp)
I	PEMBUATAN KOLOM & BALOK Lt.2	55.350.000,00
	Sub Total	55.350.000,00
	Ppn 11%	6.088.500,00
	Jumlah	61.438.500,00
	Dibulatkan	61.438.500,00

Terbilang : "ENAM PULUH SATU JUTA EMPAT RATUS TIGA PULUH DELAPAN RIBU LIMA RATUS RUPIAH"

**RENCANA ANGGARAN DAN BIAYA
BIDANG INFRASTRUKTUR**

Kota : SAMARINDA
Kecamatan : SAMARINDA SEBERANG
Kelurahan : SUNGAI KELEDANG

Kegiatan : PEMBUATAN KOLOM & BALOK Lt.2
Volume : BALOK 25/40 cm, KOLOM ϕ 40 cm
Lokasi : Jl. APT PRANOTO, RT.36, PERUM BPB

NO	URAIAN	SATUAN	VOLUME	HARGA SATUAN	TOTAL BIAYA
				Rp	Rp
1	2	3	4	5	6 = 4x5
1	UPAH KERJA				
	1. Tukang	HOK	16,0	150.000,00	2.400.000,00
	2. Pekerja	HOK	35,0	110.000,00	3.850.000,00
				Jumlah 1	6.250.000,00
2	BAHAN				
	KOLOM DIAMETER 40cmX4mX18bh= 9,04 M3				
	1. Semen 50 Kg	Sak	59,0	68.000,00	4.012.000,00
	2. Pasir Tenggarong	M3	5,00	255.000,00	1.275.000,00
	3. Batu Pecah 2-3	M3	7,50	575.000,00	4.312.500,00
	4. Besi Beton polos full@ 8x12m	Batang	50,00	42.000,00	2.100.000,00
	5. Besi Beton Polos full @ 16x11,5m	Batang	54,00	132.000,00	7.128.000,00
	BALOK 25/40 X 80M = 8 M3				
	1. Semen 50 Kg	Sak	53,0	68.000,00	3.604.000,00
	2. Pasir Tenggarong	M3	4,00	255.000,00	1.020.000,00
	3. Batu Pecah 2-3	M3	4,50	575.000,00	2.587.500,00
	4. Besi Beton polos full@ 8x12m	Batang	96,00	42.000,00	4.032.000,00
	5. Besi Beton Polos full @ 16x11,5m	Batang	38,00	132.000,00	5.016.000,00
	6. Besi Beton polos full @ 10x12m	Batang	52,00	65.500,00	3.406.000,00
	7. Kawat Bendrat	Kg	10,00	27.500,00	275.000,00
	8. Kayu Perancah 5/7x4m	M3	2,00	2.200.000,00	4.400.000,00
	9. Paku Kayu 2"-6"	Kg	5,00	18.000,00	90.000,00
	10. Benang Bangunan	Bh	2,00	7.000,00	14.000,00
	11. Plywood 9mm	Lembar	30,00	126.500,00	3.795.000,00
				Jumlah 2	47.067.000,00
3	ALAT BANTU				
	2. Ember Cor	Bh	8,0	15.000,00	120.000,00
	3. Skop	Bh	1,0	65.000,00	65.000,00
	4. Cangkul + Gagang	Bh	2,0	125.000,00	250.000,00
	5. Keranjang Rotan	Bh	9,0	22.000,00	198.000,00
	6. Sewa Mesin Molen	Hari	4,0	350.000,00	1.400.000,00
				Jumlah 3	2.033.000,00
				Total Biaya (1+2+3)	55.350.000,00

Mengetahui/menyetujui,
Lurah Sungai Keledang



RAHMADI, S.P.
Nip. 19820831 200502 1 004

Pendamping,

INDRA PERMANA R.

Ketua Tim Perencana,

ARSYAD





PEMERINTAH KOTA SAMARINDA

**PROGRAM PEMBANGUNAN DAN PEMBERDAYAAN MASYARAKAT
PRO BEBAYA**

GAMBAR RENCANA

KEGIATAN :

PEMBERDAYAAN KELURAHAN

SUB KEGIATAN :

PEMBANGUNAN SARANA DAN PRASARANA KELURAHAN

PEKERJAAN :

PEMBUATAN KOLOM Ø 40cm & BALOK 25/40 Cm (LANTAI 2)

LOKASI :

**JL. APT PRANOTO, RT.36 PERUM BPB, BLOK D, MUSHALLA AL IKHLASH
TAHUN ANGGARAN**

2023



PEMERINTAH KOTA SAMARINDA

KEGIATAN

PEMBERDAYAAN KELURAHAN

SUB KEGIATAN

PEMBANGUNAN SARANA DAN PRASARANA KELURAHAN

PEKERJAAN

PEMBUATAN KOLOM Ø 40 cm & BALOK 25/40 cm (LANTAI 2)

LOKASI

Jl. APT Pranoto, RT. 36, PERUM BPA, BLOK D, Muahalla Al Ikhlas, Kelurahan Sungai Keledang, Kecamatan Samarinda Seberang

MENGEPAHUI/MENYETUJUI

LURAH SUNGAI KELEDANG

[Signature]
No. Pengesahan 20202 1 004

TENAGA PENDAMPING

[Signature]
Indra Firmahna Mardiana

TIM/PERENCANA

[Signature]
Anyad

KETERANGAN

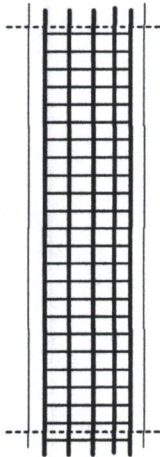
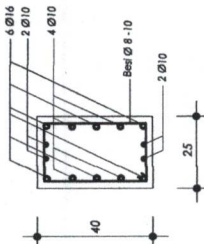

BALOK 25/40
Skala 1 : 10

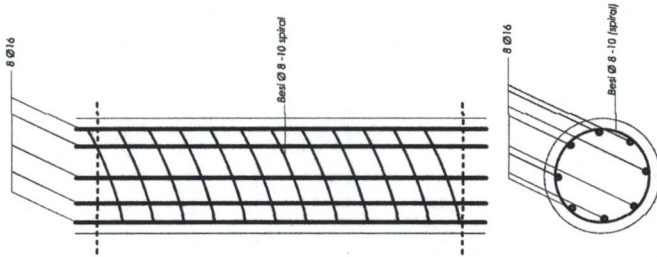

KOLOM Ø 40
Skala 1 : 10

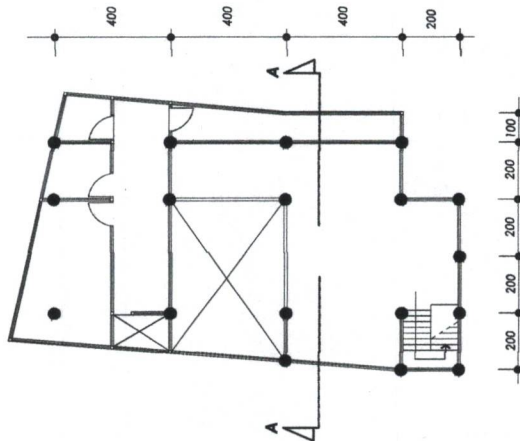

DENAH L1.2
Skala 1 : 100

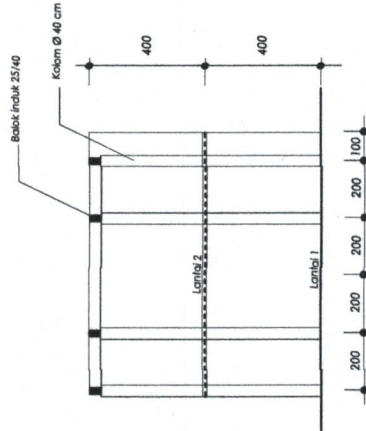

POTONGAN A-A'
Skala 1 : 100



PEMERINTAH KOTA SAMARINDA

KEGIATAN

PEMBERDAYAAN KELURAHAN

SUB KEGIATAN

PEMBANGUNAN SABANA DAN PRASARANA KELURAHAN

PEKERJAAN

PEMBUATAN KOLOM Ø 40 cm & BALOK 25/40 cm (LANTAI 2)

LOKASI

Jl. APT Pramono, RT. 36, PERUM IPS, BLOK D, Mushalla Al Ikhlas Kelurahan Sungai Keledang, Kecamatan Samarinda Seberang

MENGETAHUI/ MENYETUJUI

LURAH SUNGAI KELEDANG

[Signature]
KASIMATI, S.
No. 190300312000231004

TENAGA PENDAMPING

[Signature]
Indra Pratomo Samudra

TIM PEKERJAAN

[Signature]
Aryad

KETERANGAN

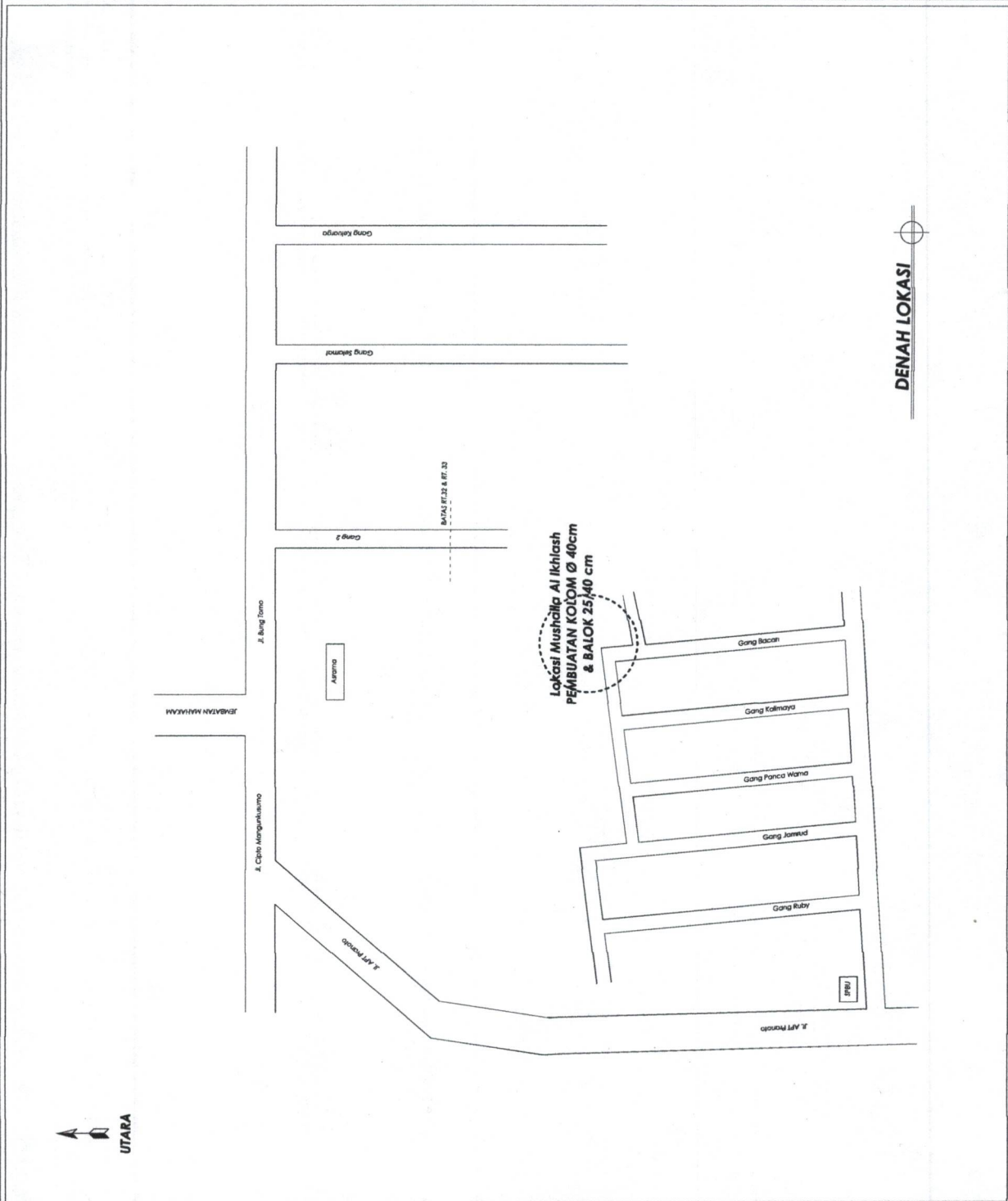

DENAH LOKASI



**RENCANA ANGGARAN BELANJA
BIDANG INFRASTRUKTUR**

Kota : Samarinda
Kec : Samarinda seberang

Kegiatan : Posyandu
Volume : 3 x 4 x 6 (2 tingkat)
72 M3

Kel : Sungai Keledang

Lokasi RT : 14, Jl. B. Tomo Gg. Al Hidayah

NO	URAIAN	SAT	VOL	HARGA SATUAN	TOTAL HARGA
1	2	3	4	5	6
1	Upah Kerja				
	1. Tukang (2 orang)	OH	40,00	Rp 150.000	6.000.000
	2. Pekerja	OH	40,00	Rp 110.000	4.400.000
	Sub Total Upah (1)				10.400.000
2	Bahan				
	1. Papan Lmbersiring 4m	Batang	180,00	45.000	8.100.000
	2. Balok Meranti 5/7 x 4m	M3	1,00	3.500.000	3.500.000
	3. Balok ulin 10/10 x 4m	M3	0,50	6.600.000	3.300.000
	4. Balok Ulin 8 /8 x 4 m	M3	0,50	6.600.000	3.300.000
	5. Balok ulin 4/8 x 4 m	Batang	78,00	85.000	6.630.000
	6. Papan Lisplang	Lembar	6,00	185.000	1.110.000
	7. Atap Seng BJLS 40 80 x 180	Lembar	35,00	48.000	1.680.000
	8. Papan bengkirai 5/25 x 4m	Lembar	8,00	413.750	3.310.000
	9. Kaca jendela 130 cm x 200 cm	Lembar	2,60	141.750	368.550
	10. Plywod 3 mm	Lembar	12,00	63.000	756.000
	11. Pintu Benkirai 80 x 190	Buah	1,00	2.500.000	2.500.000
	12. Pegangann Pintu (Holder)	Buah	2,00	183.750	367.500
	13. Engsel Jendela (Steinlis 3 ")	Buah	6,00	49.350	296.100
	14. Engsel pintu (steinlis 5 ")	Buah	8,00	69.000	552.000
	15. pegangan Jendela	Buah	2,00	15.000	30.000
	16. Baut 3/8 10 cm	pasang	15,00	33.000	495.000
	17. Paku 2,3,4 inc	Kg	10,00	26.000	260.000
	18. Semen	Zak	7,00	65.000	455.000
	19. Batu pecah 1-2 cm	M3	1,00	367.500	367.500
	20. Keramik biasa 20 x 20	kotak	11,00	75.000	825.000
	21. Papan Meranti 2/16 x 4 m	Lembar	20,00	45.000	900.000
	22. Kayu Perancah	Batang	40,95	35.000	1.433.350
	23. Pasir	M3	1,00	198.000	198.000
	Sub Total Bahan (2)				40.734.000
	Jumlah Total biaya (1 + 2)				51.134.000
	Potongan Pajak 12.5 %				6.391.750
	Total				44.742.250
	Menyetujui Lurah Sungai Keledang	Pendamping	POKMAS KELEDANG MAKMUR Ketua		
	RAHMADI NIP.19820831 200502 1 004	 NOOR QALBI	 MUCHLIS		



POKMAS KELEDANG MAKMUR

KEGIATAN

PEMBERDAYAAN KELURAHAN

SUB KEGIATAN

PEMBANGUNAN SARANA DAN PRASARANA KELURAHAN

PEKERJAAN

POSYANDU

3 m x 4 m

LOKASI

JL. BUNG TOMO GG. AL HIDAYAH RT. 14

MENGETAHUI / MENYETUJUI

LURAH SUNGAI KELEDANG

RAHMADI, S.P.

NIP. 19820831 200502 1 004

TENAGA PENDAMPING

NOOR QALBI

KETUA POKMAS



SD N 016

HOLAND BAKERY

GG. AL HIDAYAH

1/12/2022

Jl. Bung Tomo

LOKASI PEKERJAAN
POSYANDU RT 14 (3 m x 4 m)

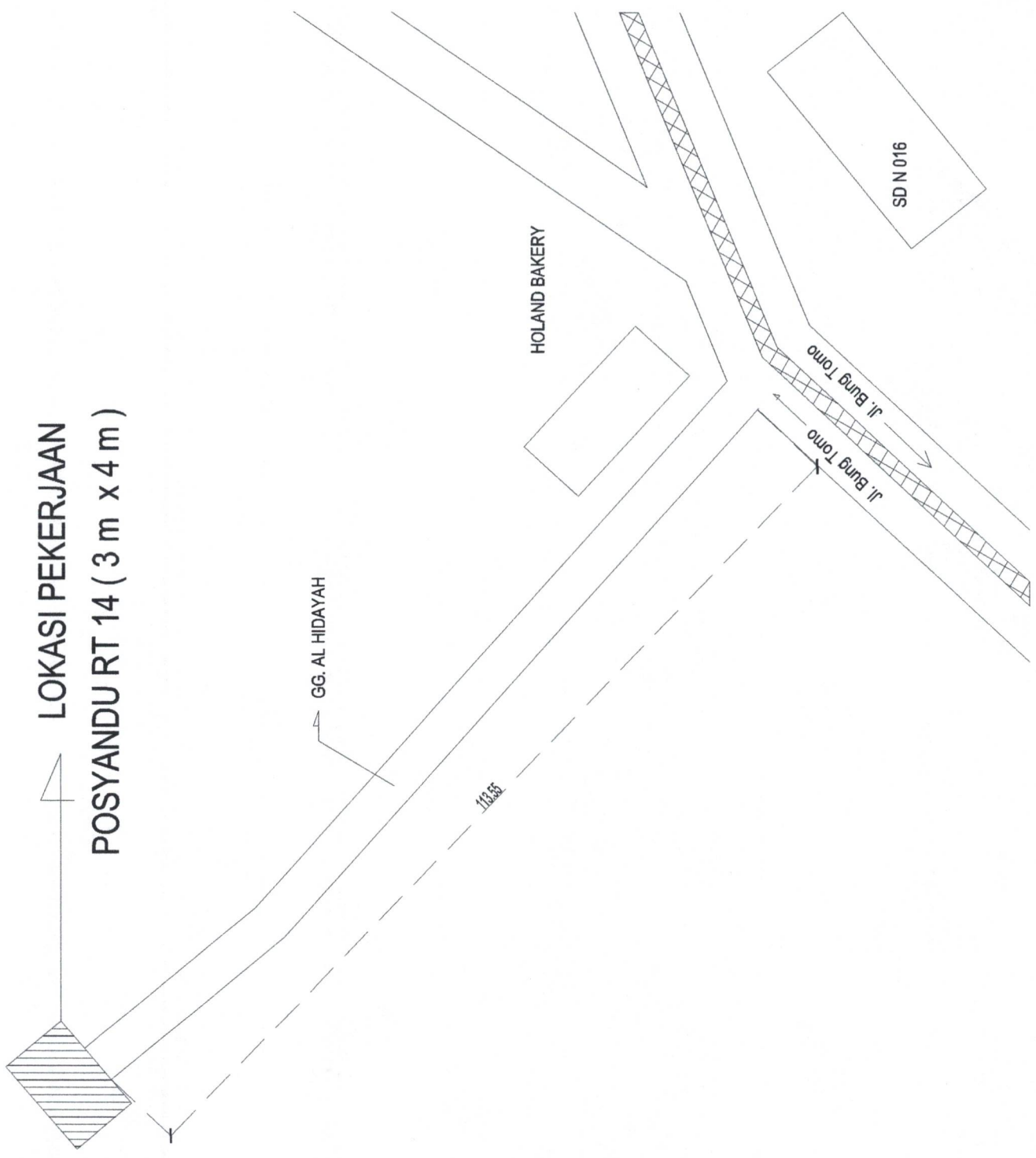



POKMAS KELEDANG MAKMUR

KEGIATAN

PEMBERDAYAAN KELURAHAN

SUB KEGIATAN

PEMBANGUNAN SARANA DAN PRASARANA KELURAHAN

PEKERJAAN

POSYANDU 2 TINGKAT

3 M x 4 M

LOKASI

JL. BUNG TOMO GG. AL HIDAYAH

RT. 14

MENGETAHUI / MENYETUJUI

LURAH SUNGAI KELEDANG

RAHMADI, S.P.

NIP 19820831 200502 1 004

TENAGA PENDAMPING

[Signature]

NOOR QALBI

KETUA POKMAS



BANGUNAN TAMPAK ATAS

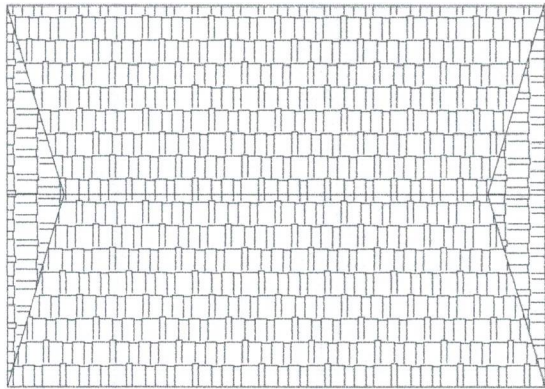

BANGUNAN TAMPAK DALAM

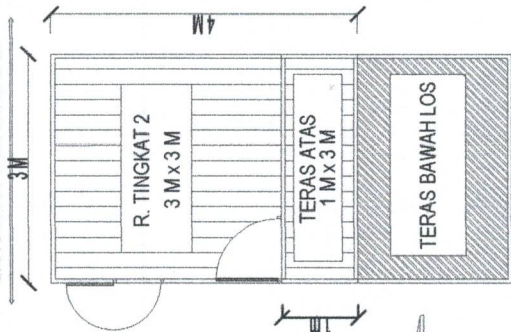

BANGUNAN TAMPAK SAMPING

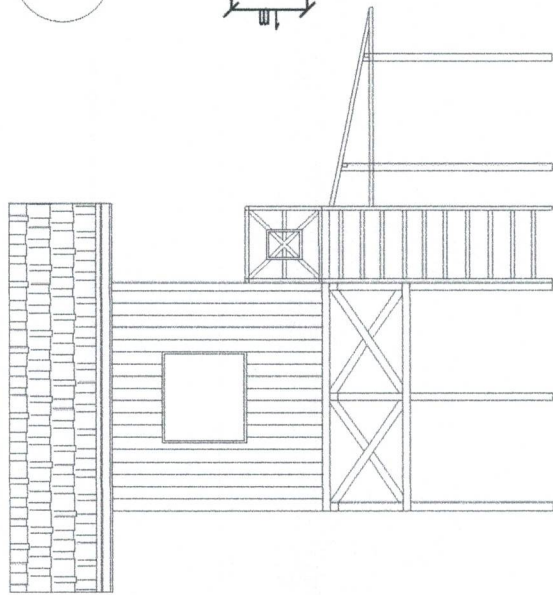

BANGUNAN TAMPAK DEPAN

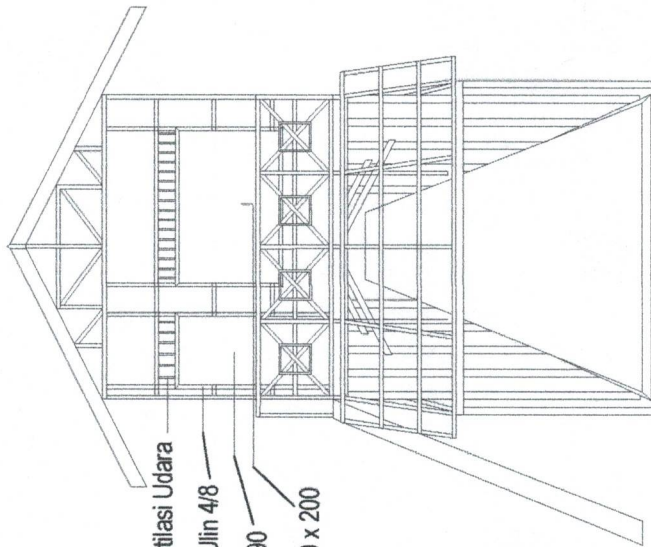
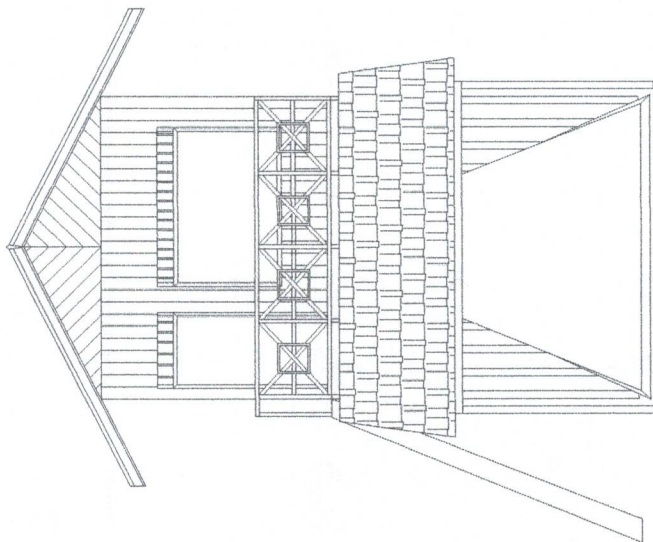

Kisi-kisi / Ventilasi Udara

Kusen Pintu Kayu Ulin 4/8

Pintu Bengkirai 80 x 190

Jendela kaca Transfran 120 x 200

Balok kuda-kuda meranti 4/8 x 4 m

Balok kaso meranti 5/5 x 4 m

Balok kuda-kuda meranti 4/8 x 4 m

Papan Listplang x 4 m

Balok Ulin Tiang Sudut 8/8 x 4 m

Balok Kusen jendela 4/8 x 4 m

Papan dinding lumbersiring 4 m

Balok Ulin Tiang Bantu 4/8 x 4 m - 3m

Balok Ulin Pagar 4/8 x 4 m

Balok Ulin Gelagar 4/8 x 4 m

Balok Gelagar meranti 4/8 x 4 m

Balok Kaso meranti 4/8 x 4 m

Balok Ulin Teras 4/8 x 4 m

Papan bengkirai 5/25 x 4 m

Balok kuda-kuda bawah ulin 4/8 x 4 m

Balok Ulin sloof 4/8 x 4 m



Tiang Pancang Ulin 10/10 x 4 m

**RENCANA ANGGARAN BELANJA
 BIDANG INFRASTRUKTUR**

Kota : Samarinda
 Kec : Samarinda seberang
 Kel : Sungai Keledang

Kegiatan : Jembatan + cor beton
 Volume : 33,5 x 2 x 2 + 40 x 2 x 0.12

Lokasi RT : 15, Jl. B. Tomo Gg. Lusi

NO	URAIAN	SAT	VOL	HARGA SATUAN	TOTAL HARGA
1	2	3	4	5	6
1 Upah					
	1. Tukang (2 orang)	OH	40,00	Rp 150.000	6.000.000
	2. Pekerja (2 orang)	OH	30,00	Rp 110.000	3.300.000
Sub Total Upah (1)					9.300.000
2 Bahan					
	1. Papan Ulin panjang 2/16 x 4 m - 2 m	Batang	80,00	85.000	6.800.000
	2. Balok ulin 4/8 x 4 m	Batang	80,00	85.000	6.800.000
	3. Kawat harmonika lobang Besar	Meter	70,00	25.000	1.750.000
	4. Plastik alas Cor	M3	70,00	2.750	192.500
	5. Baut 3/8 (10 & 15")	Pasang	60,00	33.000	1.980.000
	6. Pasir Mahakam	M3	7,00	198.000	1.386.000
	7. Batu pecah 1-2 cm	M3	9,00	367.500	3.307.500
	9. Betonmix (cairan cor Beton)	kg	7,00	45.000	315.000
	10. Paku 2, 3, 4 "	Kg	12,37	26.000	321.500
	11. Semen 50 kg	Zak	75,00	65.000	4.875.000
Sub Total Bahan (2)					27.727.500
3 Alat					
	1. Drum Plastik Sedang	buah	1,00	250.000	250.000
	3. Timba cor	buah	10,00	7.500	75.000
	4. Kasutan	buah	4,00	15.000	60.000
	5. Sekop	buah	2,00	100.000	200.000
	6. Cangkul + Gagang	buah	2,00	120.000	240.000
	7. Sewa Molen	Jam	8,00	367.500	2.940.000
	2. Gerobak / Arco	buah	2,00	600.000	1.200.000
5Sub Total Bahan (2)					4.965.000
Jumlah Total biaya (1 + 2 + 3)					41.992.500
Pembulatan					41.992.500
Menyetujui Lurah Sungai Keledang RAHMADI NIP.19820831 200502 1 004		Pendamping  NOOR QALBI		POKMAS KELEDANG MAKMUR Ketua  MUCHLIS 	

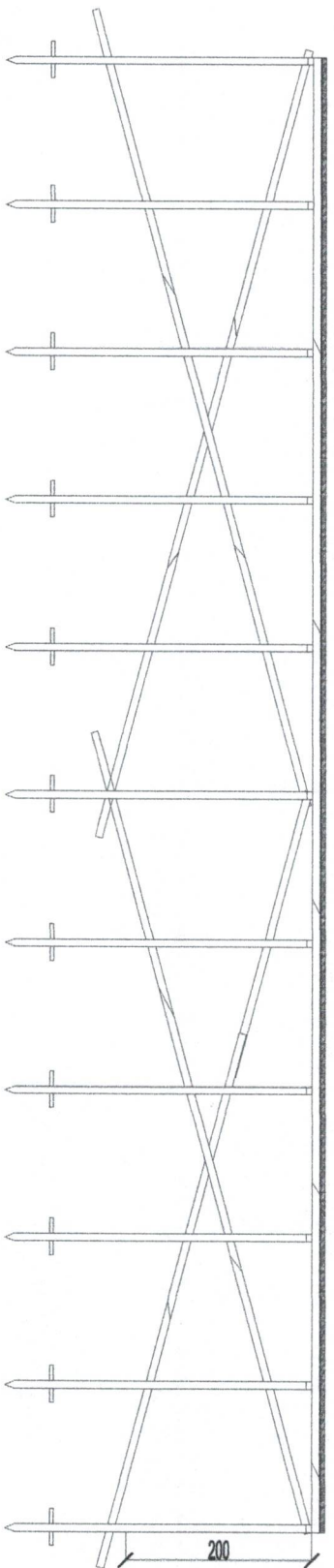

- Cor semen 40 m x 2 m x T = 8 cm
- Balok Ulin 4/8 x 4 m
- Papan Ulin 3/16 x 4 m - 2 m
- Balok Ulin 4/8 x 4 m
- Balok ulin 8/8 x 4 m - 2 m
- Balok Ulin Pancang 8/8 x 4 m
- Balok ulin 4/8 x 4 m
- Balok ulin sepatu tiang pancang 4/8 x 4m - 0.4

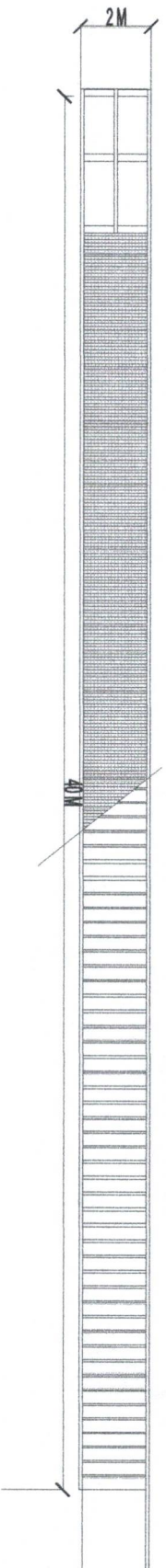

POKMAS KELEDANG MAKMUR

KEGIATAN

PEMBERDAYAAN KELURAHAN

SUB KEGIATAN

PEMBANGUNAN SARANA DAN PRASARANA KELURAHAN

PEKERJAAN

RENOVASI JEMBATAN & COR
40 x 2 M x 0.8 M

LOKASI

JL. BUNG TOMO
RT. 15

MENGETAHUI / MENYETUJUI

LURAH SUNGAI KELEDANG

RAHMADI, S.P.
NIP. 19820831 200502 1 004

TENAGA PENDAMPING

NOOR QALBI

KETUA POKMAS



SUNGAI MAHAKAM



COR LAPIS JEMBATAN RT 15

LOKASI PEKERJAAN COR LAPIS JEMBATAN KAYU # (33 m x 2 m x 0.12 m)

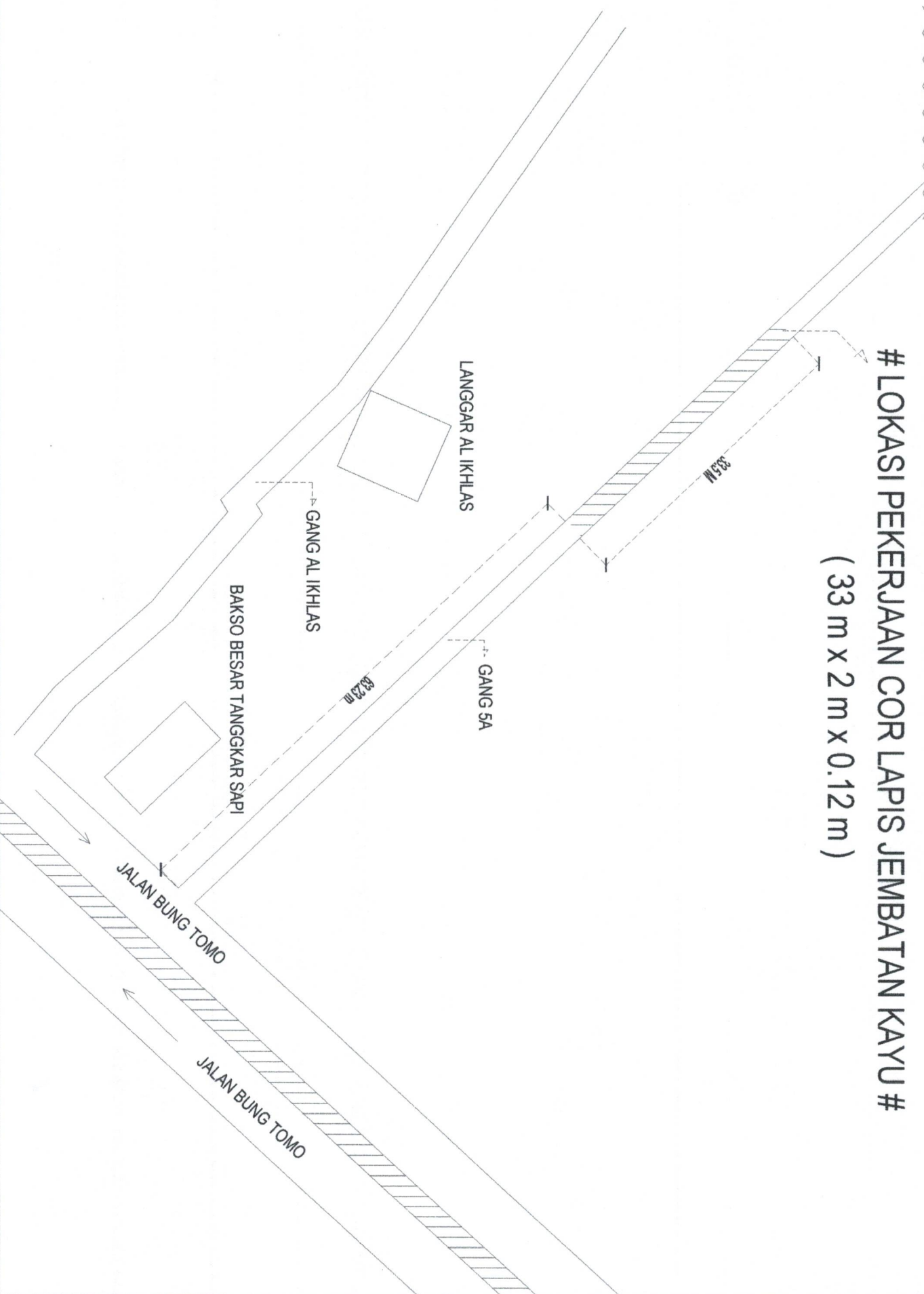

POKMAS KELEDANG MAKKUR

KEGIATAN

PEMBERDAYAAN KELURAHAN

SUB KEGIATAN

PEMBANGUNAN SARANA DAN PRASARANA KELURAHAN

PEKERJAAN

REHAB JEMBATAN + COR

33 m x 2 m

LOKASI

JALAN BUNG TOMO GG. SA

RT. 15

MENGETAHUI / MENYETUJUI

LURAH SUNGAI KELEDANG

RAHMADI, S.P.

NIP. 19820831 200502 1 004

TENAGA PENDAMPING

NOOR QALBI

KETUA POKMAS





**RENCANA ANGGARAN BELANJA
BIDANG INFRASTRUKTUR**

Kota : Samarinda
Kec : Samarinda seberang
Kel : Sungai Keledang

Kegiatan : Pos Pemadam
Volume : 3 X 4

12 M3

Lokasi RT : 16, Jl. B. Tomo Gg. Al Ikhlas

NO	URAIAN	SAT	VOL	HARGA SATUAN	TOTAL HARGA
1	2	3	4	5	6
1	Upah Kerja				
	1. Tukang	OH	42,00	Rp 150.000	6.300.000
	2. Pekerja	OH	28,00	Rp 100.000	2.800.000
	Sub Total Upah (1)				9.100.000
2	Bahan				
	1. Papan Ulin 2/16 x 400	Batang	100,00	85.000	8.500.000
	2. Balok ulin 8/8 x 400	Batang	25,00	168.000	4.200.000
	3. Balok ulin 4/8 x 400	Batang	45,00	85.000	3.825.000
	4. Balok Meranti 5/5 x 400	batang	8,00	35.000	280.000
	5. Papan Lisplang 4 M	Lembar	7,00	185.000	1.295.000
	6. Atap Seng BJLS 40 (80 x 180)	Lembar	15,00	48.000	720.000
	7. Balok Ulin 5 /5 x 400	Batang	8,00	75.000	600.000
	8. Pintu Bahan Ulin 80 x 190	Buah	2,00	1.800.000	3.600.000
	9. Pegangann Pintu	Buah	2,00	250.000	500.000
	10. Engsel Jendela	Buah	6,00	10.000	60.000
	11. Engsel pintu	Buah	8,00	15.000	120.000
	12. Pegangan Jendela	Batang	2,00	7.000	14.000
	13. Baut 3/8 10 cm	Pasng	8,00	33.000	264.000
	14. Paku 2,3,4 inc	Kg	8,00	26.000	208.000
	Sub Total Bahan (2)				24.186.000
	Jumlah Total biaya (1 + 2)				33.286.000
	Total				33.286.000
	Menyetujui Lurah Sungai Keledang RAHMADI NIP.19820831 200502 1 004	Pendamping  NOOR QALBI	POKMAS KELEDANG MAKMUR Ketua  		

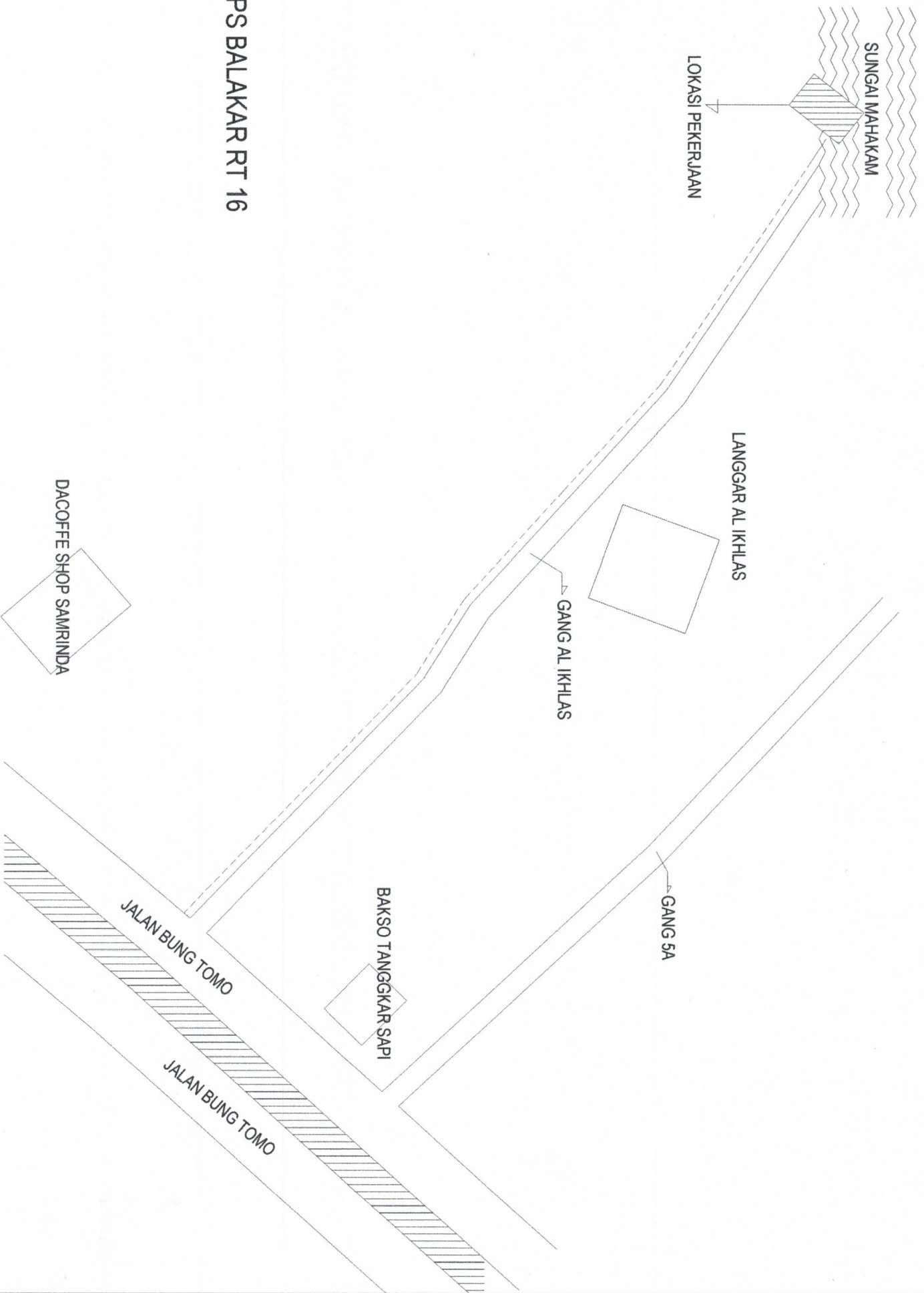

PS BALAKAR RT 16



POKMAS KELEDANG MAKMUR

KEGIATAN

PEMBERDAYAAN KELURAHAN

SUB KEGIATAN

PEMBANGUNAN SARANA DAN PRASARANA KELURAHAN

PEKERJAAN

POS DAMKAR
4 m x 3 m

LOKASI

JL. BUNG TOMO GG. AL IKHLAS
RT. 16

MENGETAHUI / MENSETUJUI

LURAH SUNGAI KELEDANG

RAHMADI, S.P.
NIP. 19820831 200502 1 004

TENAGA PENDAMPING

(Signature)

NOOR GALBI

KETUA POKMAS



KETERANGAN

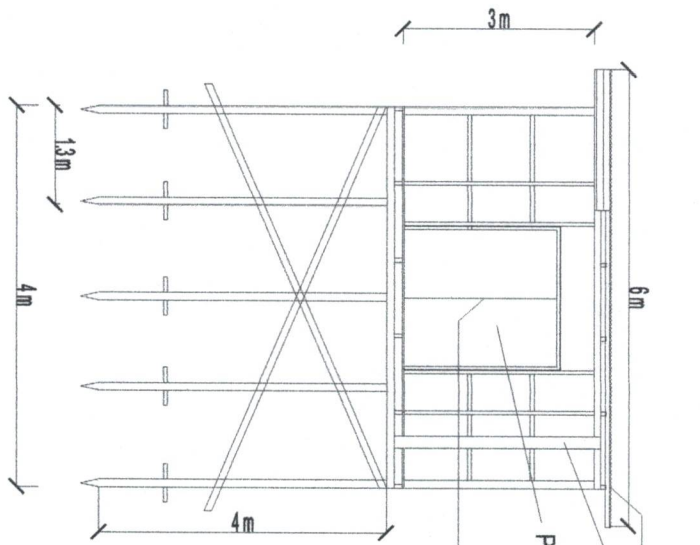

Atap Seng 3 m Gelombang Kecil

Papan Lisplank 4m

Papan Dinding Kayu Ulin Lumbersiring

Tiang Sudut ulin 8/8 x 3m

Pintu Bengkai 80 cm x 190 cm

Tiang Bantu Ulin 4/8 x 3m

Kusen Jendela Ulin 4/8 x 4m - 1.2

Papan Lantai Ulin 2/16 x 4m x 4m x 2.5 m

Kusen pintu Ulin 4/8 x 4m

Sloff balok Ulin 8/8 x 4m

Gelagar ulin 4/8 x 4m

Tiang Pancang Balok Ulin 8/8 x 4m

Balok Suai / Penahan ulin 4/8 x 4m

Sepatu Tiang Pancang Balok Ulin 4/8 x 4m - 0.4m

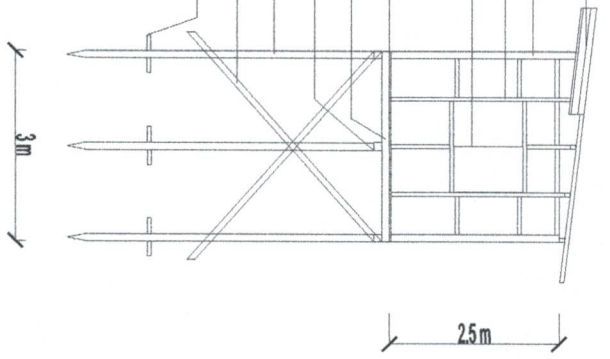

BANGUNAN TAMPAK DEPAN

BANGUNAN TAMPAK SAMPIING

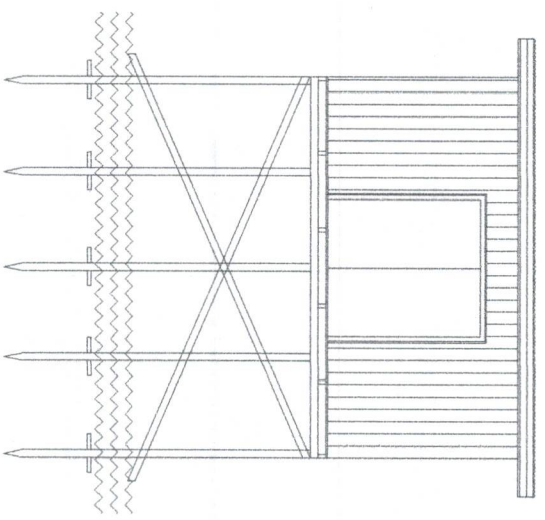

Kusen pintu & jendela

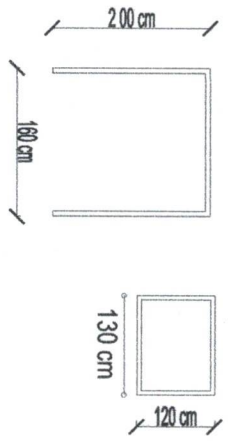

DENAH

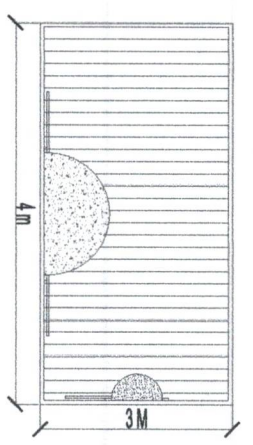

POKMAS KELEDANG MAKMUR

KEGIATAN

PEMBERDAYAAN KELURAHAN

SUB KEGIATAN

PEMBANGUNAN SARANA DAN PRASARANA KELURAHAN

PEKERJAAN

PEMBUATAN POS BALAKAR

4 m x 3 m

LOKASI

JL. BUNG TOMO GG. AL IKHLAS RT. 16

MENGETAHUI / MENYETUJUI

LURAH SUNGAI KELEDANG

RAHMADI, S.P.

NIP 19820831 200502 1 004

TENAGA PENDAMPING

NOOR QALBI

KETUA POKMAS



KETERANGAN

**RENCANA ANGGARAN BELANJA
BIDANG INFRASTRUKTUR**

Kota : Samarinda
Kec : Samarinda seberang
Kel : Sungai Keledang

Kegiatan : Jembatan Kayu
Volume : 20 x 2.5 x 3
100 M3

Lokasi RT : 16, Jl. Bung Tomo Gg. Al Ikhlas

NO	URAIAN	SAT	VOL	HARGA SATUAN	TOTAL HARGA
1	2	3	4	5	6
	Jembatan Kayu				
1	Upah Kerja				
	1. Kepala Tukang	HOK	52,00	Rp 150.000	7.800.000
	3. Pekerja	HOK	26,00	Rp 110.000	2.860.000
	Sub Total Upah (1)				10.660.000
	Bahan				
2	1. Papan Ulin panjang 3/16 x 4 m - 2.5 m	M3	1,50	6.600.000	9.900.000
	2. Balok ulin 4/8 x 4 m	Batang	70,00	85.000	5.950.000
	3. Balok Ulin 5 /7 x 4 m	Batang	40,00	92.000	3.680.000
	4. Balok Ulin 5 /5 x 4 m	Batang	10,00	66.000	660.000
	5. Baut 3/8 10 cm	Kg	10,00	33.000	330.000
	6. Paku 2,3,4 inc	Kg	10,00	26.000	260.000
	Sub Total Bahan (2)				20.780.000
	Jumlah Total biaya (1 + 2)				31.440.000
	Total				31.440.000

Menyetujui
Lurah Sungai Keledang

RAHMADI
NIP.19820831 200502 1 004

Pendamping

NOOR QALBI

POKMAS KELEDANG MAKMUR
Ketua

MUCHLIS



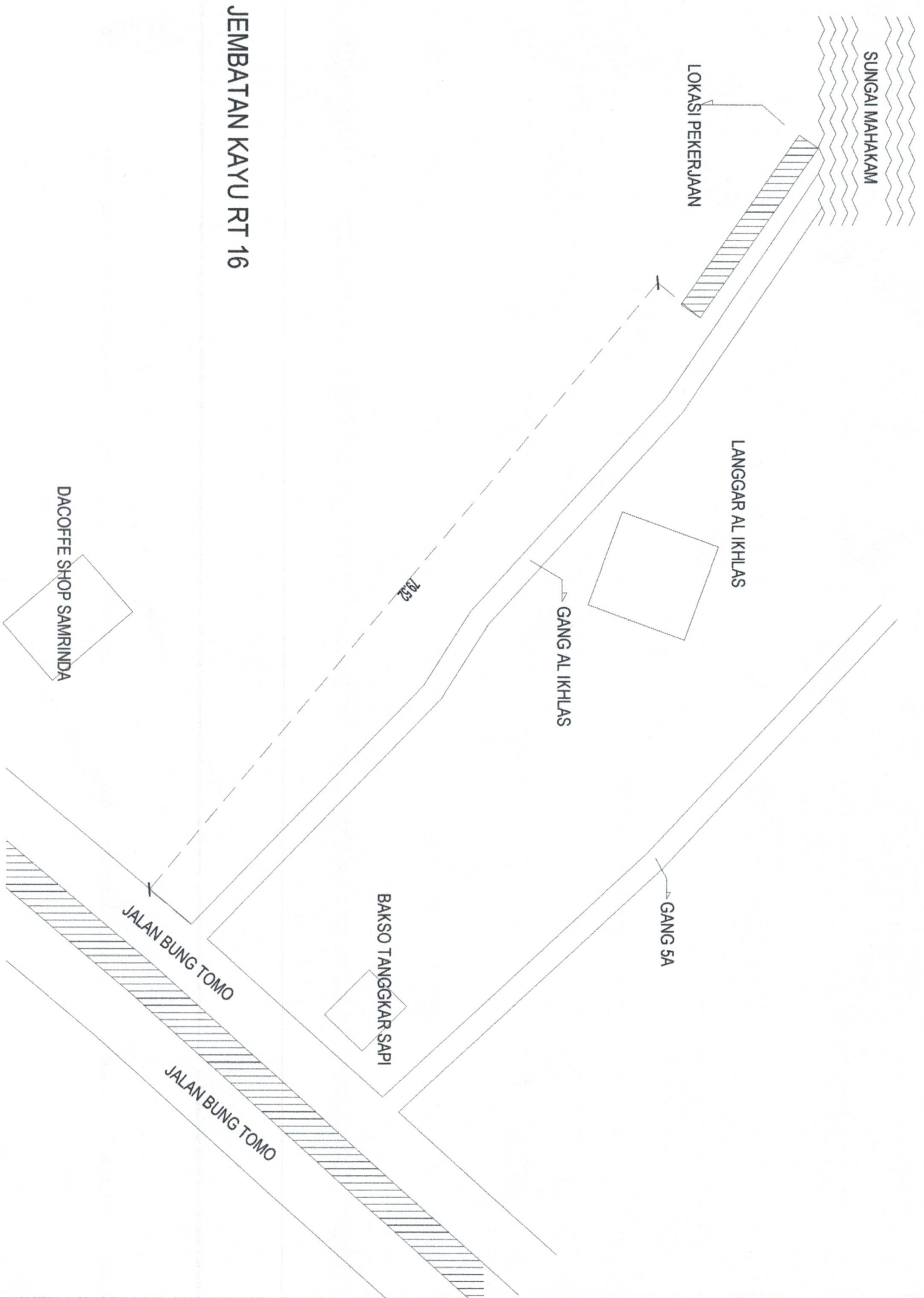

POKMAS KELEDANG MAKMUR

KEGIATAN

PEMBERDAYAAN KELURAHAN

SUB KEGIATAN

PEMBANGUNAN SARANA DAN PRASARANA KELURAHAN

PEKERJAAN

JEMBATAN KAYU

20 x 2,5

LOKASI

JL. BUNG TOMO GG. AL IKHLAS
RT. 16

MENGETAHUI / MENYETUJUI

LURAH SUNGAI KELEDANG

RAHMADI, S.P.

NIP. 19820831 200502 1 004

TENAGA PENDAMPING

NOOR QALBI

KETUA POKMAS



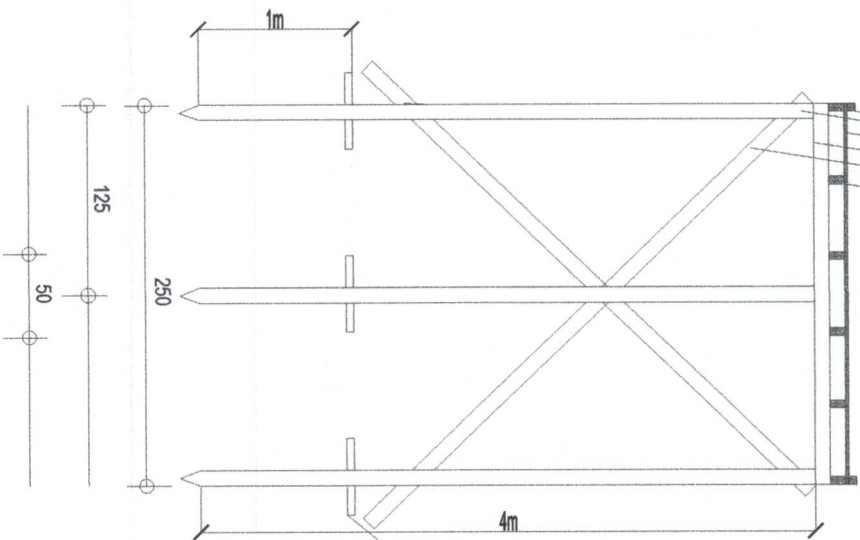
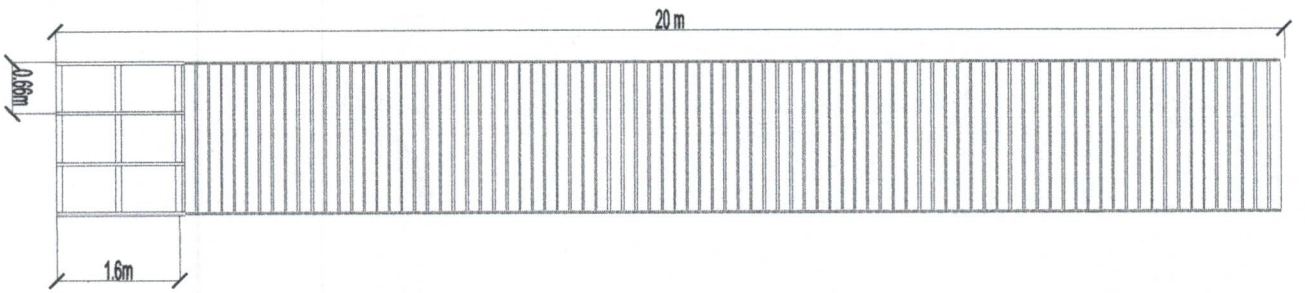

- Balok ulin Penjepit 5/5 x 4m
- Balok ulin pancang 4/8 x 4m
- Papan lantai ulin 3/16 x 2m
- Balok Ulin 4/8 x 4m - 2m
- Balok Ulin 4/8 x 4m
- Balok Ulin 4/8 x 4m

Sepatu Tiang Pancang Ulin 4/8 x 4 m - 0.4 m

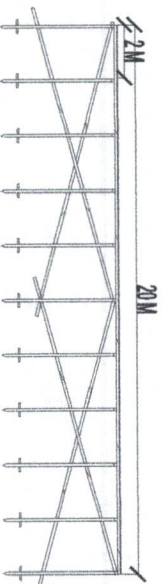

POKMAS KELEDANG MAKMUR

KEGIATAN

PEMBERDAYAAN KELURAHAN

SUB KEGIATAN

PEMBANGUNAN SARANA DAN PRASARANA KELURAHAN

PEKERJAAN

PEMBUATAN JEMBATAN KAYU

20 x 25

LOKASI

JL. BUNG TOMO

RT. 16

MENGETAHUI / MENYETUJUI

LURAH SUNGAI KELEDANG

RAHMADI, S.P.

NIP. 19820831 200502 1 004

TENAGA PENDAMPING

NOOR GALBI

KETUA POKMAS





KETERANGAN

**RENCANA ANGGARAN BELANJA
BIDANG INFRASTRUKTUR**

Kota : Samarinda
Kec : Samarinda seberang
Kel : Sungai Keledang

Kegiatan : Renovasi jembatan
Volume : 2 m x 10 m
20 M3
Lokasi RT : 17, Jl. Bung Tomo Gg. 1

NO	URAIAN	SAT	VOL	HARGA SATUAN	TOTAL HARGA
1	2	3	4	5	6
	I UPAH KERJA				
	1. Tukang	HOK	12,00	Rp 150.000	1.800.000
	2. Pekerja (2 orang)	HOK	15,00	Rp 110.000	1.650.000
	Sub Total Upah (1)				3.450.000
	PEMBANGUNAN JEMBATAN				
	2 BAHAN				
	1. Papan Ulin 2/16 x 4 m	Lembar	30,00	100.000	3.000.000
	2. Balok Ulin 4/8 x 4 m	Batang	12,00	85.000	1.020.000
	3. Baut 3/8 10 cm	Pasng	9,00	33.000	297.000
	4. Paku 2,3,4 inc	Kg	5,00	26.000	130.000
	Sub Total Bahan (2)				4.447.000
	Jumlah Total biaya (1 + 2)				7.897.000
	Pembulatan				7.897.000
	Menyetujui Lurah Sungai Keledang RAHMADI NIP.19820831 200502 1 004	Pendamping  NOOR QALBI	POKMAS KELEDANG MAKMUR Ketua  MUCLIS 		

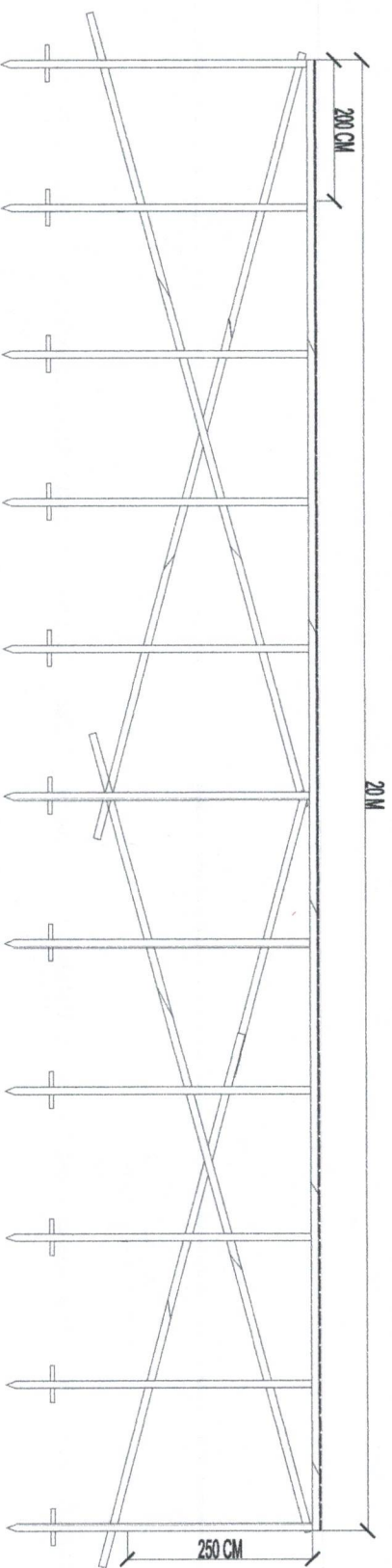
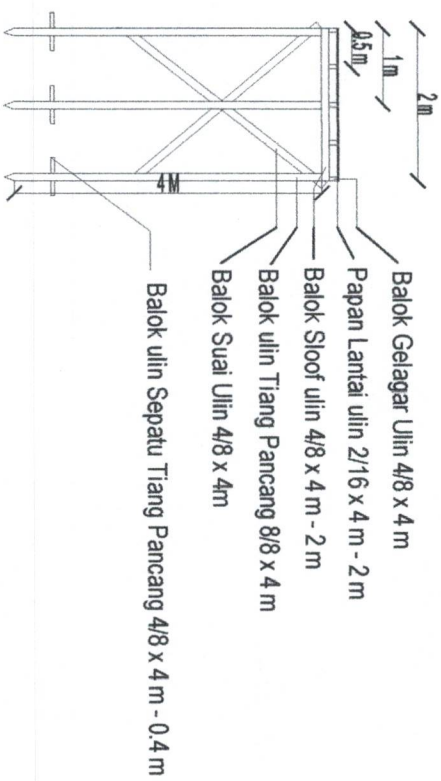
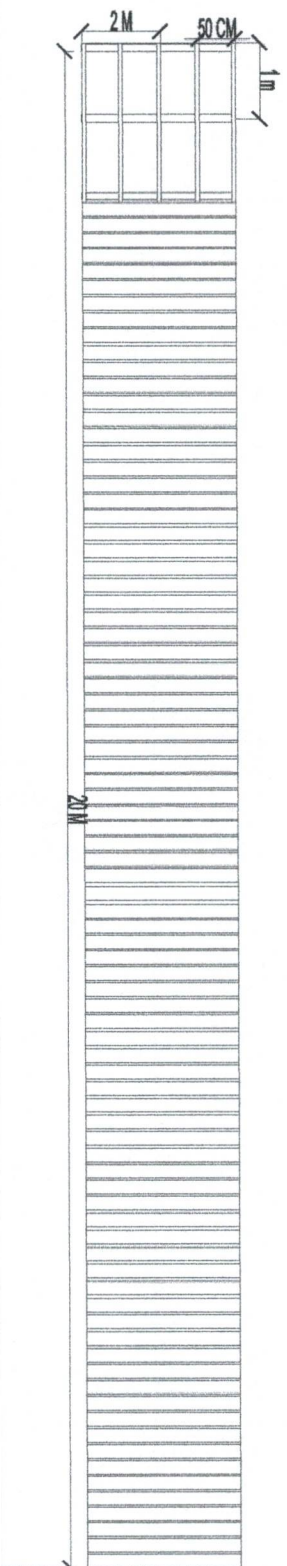

POKMAS KELEDANG MAKMUR

KEGIATAN

PEMBERDAYAAN KELURAHAN

SUB KEGIATAN

PEMBANGUNAN SARANA DAN PRASARANA KELURAHAN

PEKERJAAN

RENOVASI JEMBATAN KAYU

10 x 2

LOKASI

JL. BUNG TOMO GG. 1

RT. 17

MENGETAHUI / MENYETUJUI

LURAH SUNGAI KELEDANG

RAHMADI, S.P.

NIP. 19820831 200502 1 004

TENAGA PENDAMPING

NOOR QALBI

KETUA POKMAS



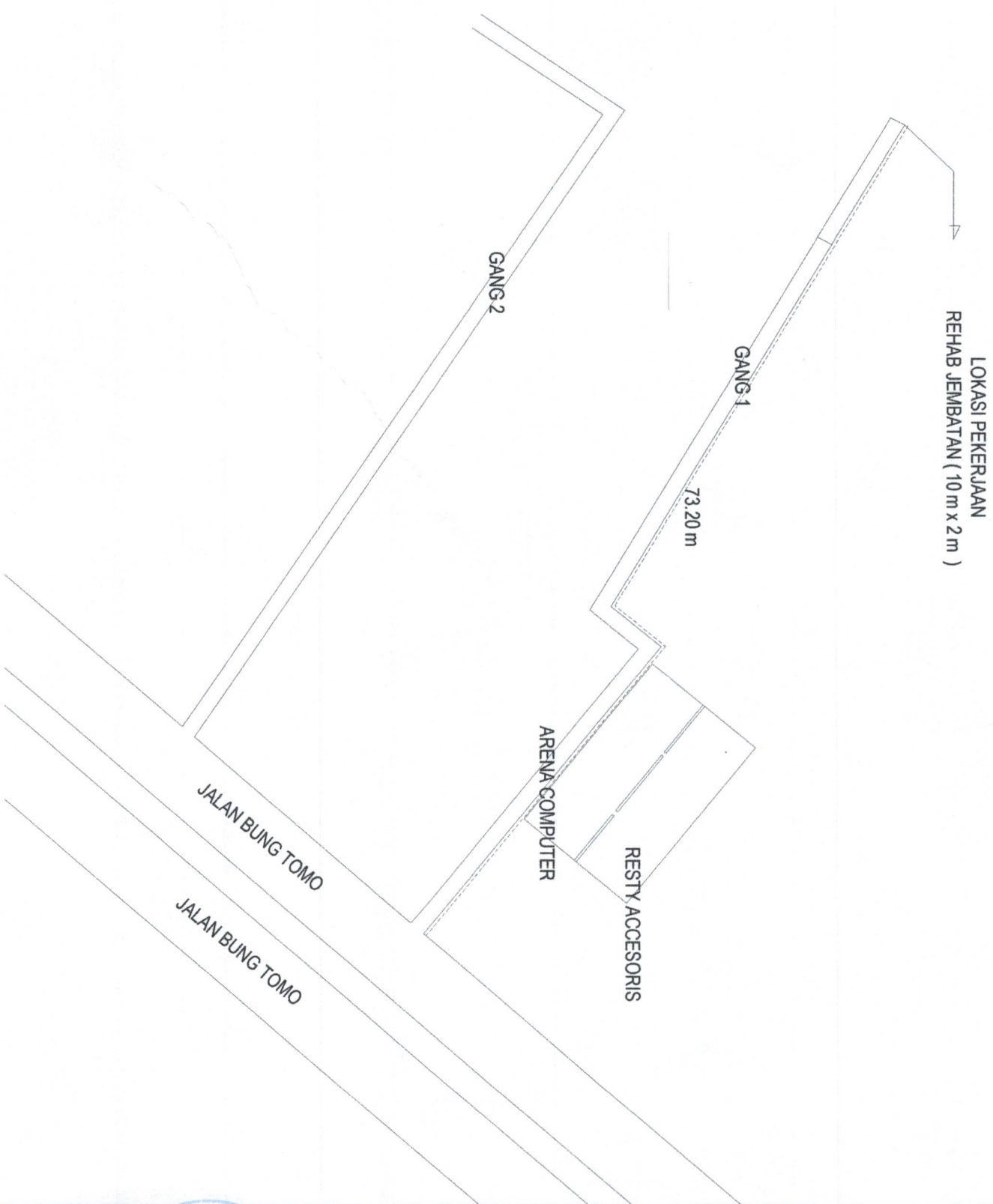

POKMAS KELEDANG MAKMUR

KEGIATAN

PEMBERDAYAAN KELURAHAN

SUB KEGIATAN

PEMBANGUNAN SARANA DAN PRASARANA KELURAHAN

PEKERJAAN

REHAB JEMBATAN
10 m x 2 m x 3 m

LOKASI

JL. BUNG TOMO GG. 1
RT. 17

MENGETAHUI / MENYETUJUI

LURAH SUNGAI KELEDANG

RAHMADI, S.P.
NIP. 19820831 200502 1 004

TENAGA PENDAMPING

NOOR GALBI

KETUA POKMAS





**RENCANA ANGGARAN BELANJA
BIDANG INFRASTRUKTUR**

Kota : Samarinda
Kec : Samarinda seberang
Kel : Sungai Keledang

Kegiatan : Pembangunan Posyandu
Volume : 3 m x 5 m x 3.5 m
45 M3

Lokasi RT : Jl. Bung Tomo RT. 17 Gg. 2

NO	URAIAN	SAT	VOL	HARGA SATUAN	TOTAL HARGA
1	2	3	4	5	6
1	UPAH KERJA				
	1. Tukang	HOK	15,00	Rp 150.000	Rp 2.250.000
	2. Pekerja (2 orang)	HOK	50,00	Rp 110.000	Rp 5.500.000
	Sub Total Upah (1)				Rp 7.750.000
2	BAHAN				
	1. Balok Ulin 8/8 x 4 m	potong	40,00	Rp 103.125	Rp 4.125.000
	2. Balok Ulin 4/8 x 4 m	potong	90,00	Rp 85.000	Rp 7.650.000
	3. Balok Meranti 4/8 x 4 m	potong	50,00	Rp 45.000	Rp 2.250.000
	4. Papan Lantai ulin 2/16 x 4 m	M3	1,00	Rp 6.600.000	Rp 6.600.000
	5. Kayu Lambersiring 4m	Lembar	150,00	Rp 31.250	Rp 4.687.500
	6. Pintu Kusen	M3	1,00	Rp 2.000.000	Rp 2.000.000
	7. Kunci	Buah	1,00	Rp 283.800	Rp 283.800
	8. Kaca 1.5m x 1.5 x 5mm	Buah	1,00	Rp 297.000	Rp 297.000
	9. Closed	Buah	1,00	Rp 200.000	Rp 200.000
	10. Balok meranti 5/7 Meranti	M3	1,00	Rp 3.500.000	Rp 3.500.000
	11. Engsel Pintu	Buah	10,00	Rp 60.000	Rp 600.000
	12. Paku	Kg	14,00	Rp 26.000	Rp 364.000
	13. Papan Lisplank	Buah	10,00	Rp 185.000	Rp 1.850.000
	14. Atap Sakura Roop 77cm x 80cm	Lembar	19,00	Rp 42.000	Rp 798.000
	15. paku Multy Roof	Kg	1,00	Rp 48.500	Rp 48.500
	16. Baut 3 / 8 (10 cm, 15 cm)	pasang	30,00	Rp 33.000	Rp 990.000
	Sub total bahan (2)				Rp 36.243.800
	Jumlah Total biaya (1 + 2)				Rp 43.993.800
	Pembulatan				Rp 43.994.000
	Menyetujui Lurah Sungai Keledang RAHMADI NIP.19820831 200502 1 004	Pendamping  NOOR QALBI		POKMAS KELEDANG MAKMUR Ketua  MUCHLIS 	

BANGUNAN TAMPAK SAMPIING

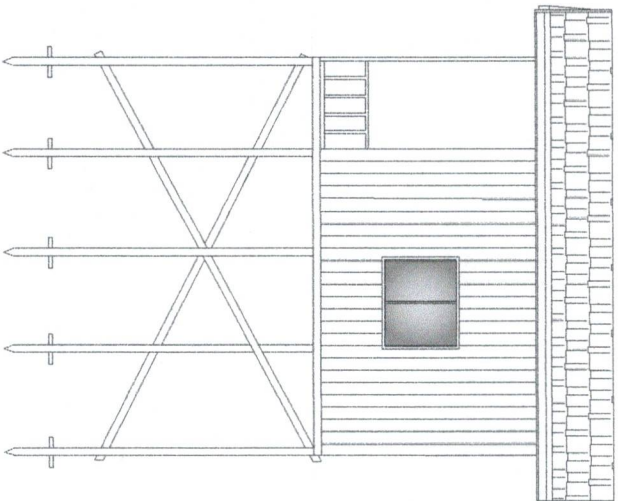

BANGUNAN TAMPAK ATAS

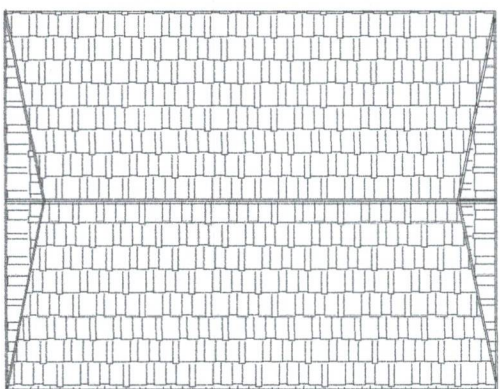

BANGUNAN TAMPAK DEPAN

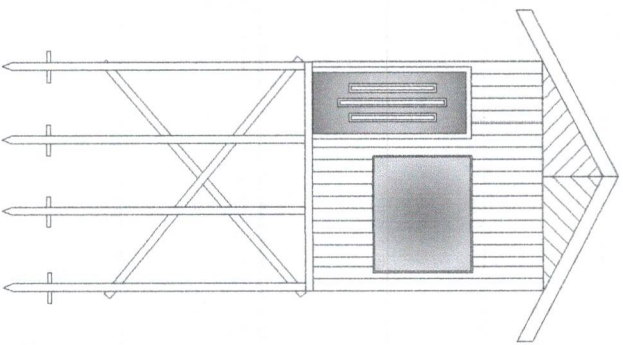

Kusen Pintu & Jendela

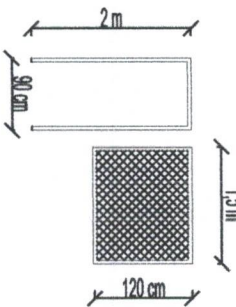

BANGUNAN TAMPAK DALAM

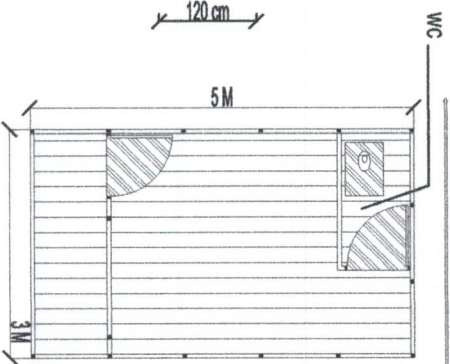

Gording Balok meranti 5/7 x 4m

Kaso Balok Meranti

Jendela Kayu 160 cm x 150 cm

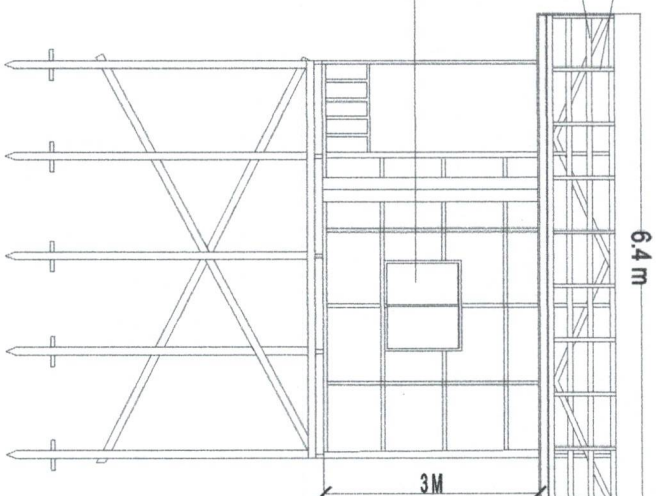

- Papan Lisplank 4m
- Kuda kuda Balok Meranti 5/7 x 4m
- Papan Dinding Kayu Ulin Lumbersiring
- Tiang Sudut ulin 8/8 x 3m
- Tiang Bantu Ulin 4/8 x 3m
- Kusen Jendela Ulin 4/8 x4m -1.2
- Pintu Bengkirai 80 cm x 190 cm
- Kusen pintu Ulin 4/8 x 4m
- Sloff balok Ulin 8/8 x 4m
- Gelagar ulin 4/8 x 4m
- Balok Suai / Penahan ulin 4/8 x 4m
- Tiang Pancang Balok Ulin 8/8 x 4m
- Sepatu Tiang Pancang Balok Ulin 4/8 x 4m - 0.4m



POKMAS KELEDANG MAKMUR

KEGIATAN

PEMBERDAYAAN KELURAHAN

SUB KEGIATAN

PEMBANGUNAN SARANA DAN PRASARANA KELURAHAN

PEKERJAAN

PEMBUATAN POSYANDU

3 M x 5 M

LOKASI

JL. BUNG TOMO GG. 2

RT. 17

MENGETAHUI / MENYETUJUI

LURAH SUNGAI KELEDANG

RAHMADI, S.P.

NIP 19820831 200502 1 004

TENAGA PENDAMPING

Noor Qalbi

NOOR QALBI

KETUA POKMAS





POKMAS KELEDANG MAKMUR

KEGIATAN

PEMBERDAYAAN KELURAHAN

SUB KEGIATAN

PEMBANGUNAN SARANA DAN PRASARANA KELURAHAN

PEKERJAAN

POSYANDU

3 x 5 x

LOKASI

JL. BUNG TOMO GG.2
RT. 17

MENGETAHUI / MENYETUJUI

LURAH SUNGAI KELEDANG

RAHMADI, S.P.

NIP. 19820831 200502 1 004

TENAGA PENDAMPING



NOOR QALBI



KETUA POKMAS





**RENCANA ANGGARAN BELANJA
BIDANG INFRASTRUKTUR**

Kota : Samarinda
Kec : Samarinda seberang
Kel : Sungai Keledang

Kegiatan : Semenisasi Lapangan
Volume : 5 m x 9m x 0.12 cm
7 M3
Lokasi RT : 17, Jl. B. Tomo Gg. 1

NO	URAIAN	SAT	VOL	HARGA SATUAN	TOTAL HARGA
1	2	3	4	5	6
1	UPAH KERJA				
	1. Tukang	HOK	4,00	Rp 150.000	600.000
	2. Pekerja (2 orang)	HOK	20,00	Rp 110.000	2.200.000
	Sub Total Upah (1)				2.800.000
2	Semenisasi BAHAN				
	1. Semen 50 kg	Zak	48,00	65.000	3.120.000
	2. Pasir Mahakam	M3	5,00	198.000	990.000
	3. Batu Pecah 1-2 cm	M3	6,00	367.500	2.205.000
	4. Kayu 5/7 Meranti	Potong	10,00	49.000	490.000
	5. Paku (2 , 3 inc)	Kg	2,50	26.000	65.000
	6. Plywod 9 m	Lembar	6,00	126.500	759.000
	7. Plastik Cor	M3	60,00	2.750	165.000
	Sub Total Bahan (2)				7.794.000
	Jumlah Total biaya (1 + 2)				10.594.000
	Pembulatan				10.594.000
	Menyetujui Lurah Sungai Keledang RAHMADI NIP.19820831 200502 1 004	Pendamping  NOOR QALBI	POKMAS KELEDANG MAKMUR Ketua   MUCHLIS		

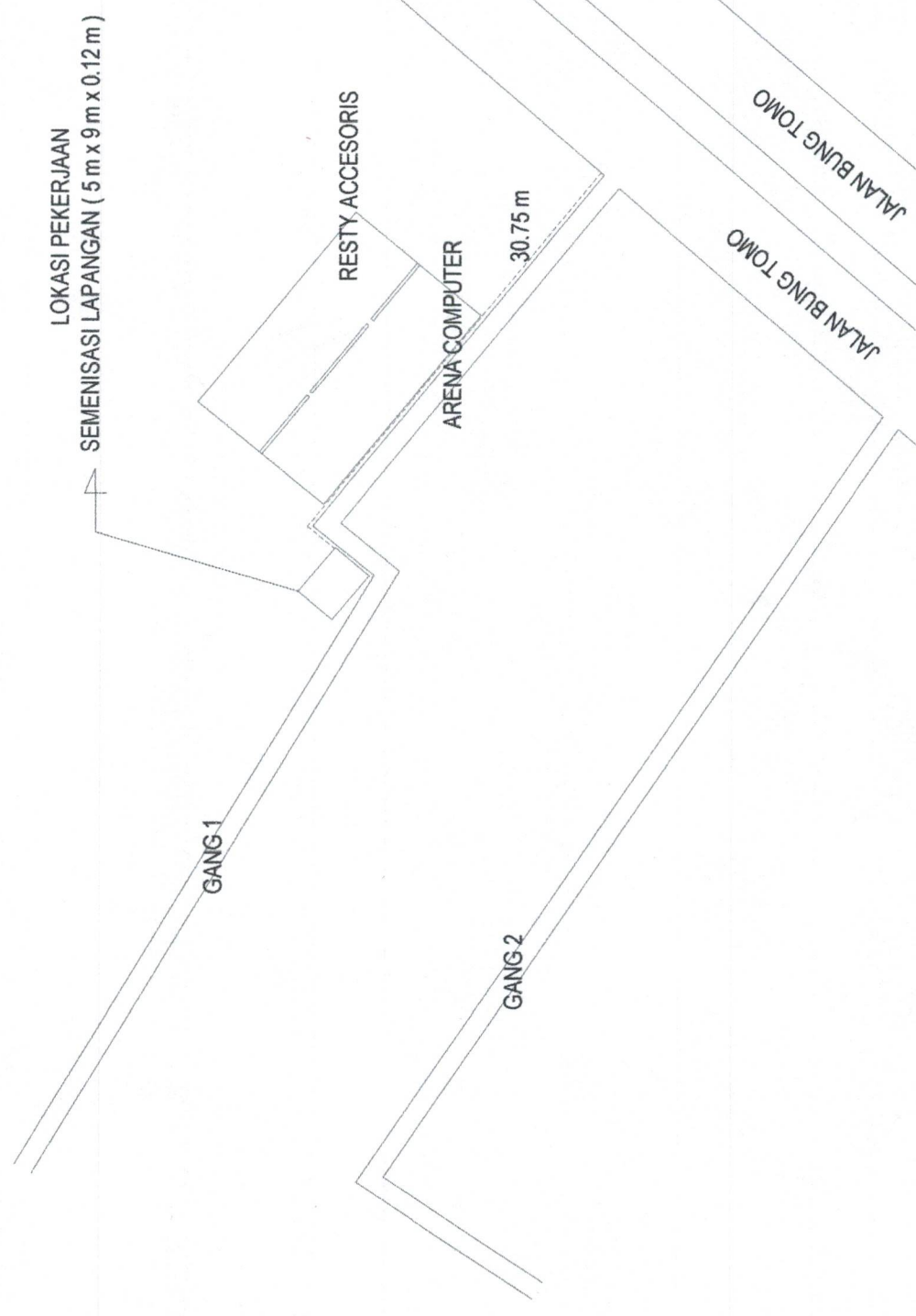

POKMAS KELEDANG MAKMUR
KEGIATAN
PEMBERDAYAAN KELURAHAN
SUB KEGIATAN
PEKERJAAN
PEMBANGUNAN SARANA DAN PRASARANA KELURAHAN
PEKERJAAN
PEKERJAAN
SEMENISASI 5 x 9 x 0.12
LOKASI
JL. BUNG TOMO GG. 1 RT. 17
MENGETAHUI / MENYETUJUI
LURAH SUNGAI KELEDANG
RAHMADI, S.P. NIP 19820831 200502 1 004
TENAGA PENDAMPING

NOOR QALBI
KETUA POKMAS

MUCHLIS
KETERANGAN





POKMAS KELEDANG MAKMUR

KEGIATAN

PEMEBERDAYAAN KELURAHAN

SUB KEGIATAN

PEMBANGUNAN SARANA DAN PRASARANA KELURAHAN

PEKERJAAN

PELEBARAN GANG & LAPANGAN
6 x 12 x 0.12

LOKASI

JL. BUNG TOMO GG. 1
RT. 17

MENGETAHUI / MENYETUJUI
LURAH SUNGAI KELEDANG

RAHMADI, S.P.
NIP. 19820831 200502 1 004
TENAGA PENDAMPING

NOOR QALBI

KETUA POKMAS

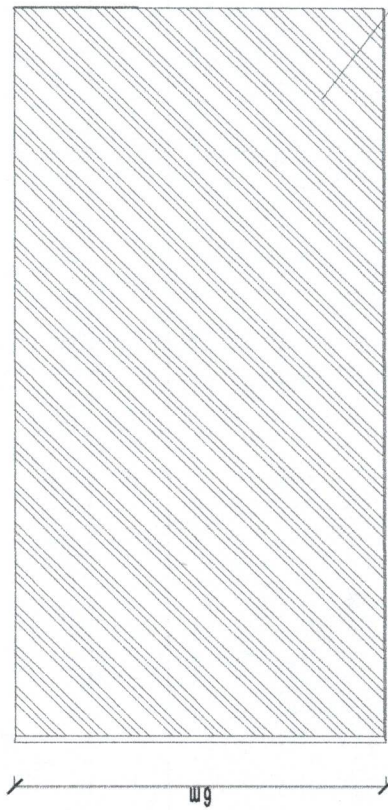
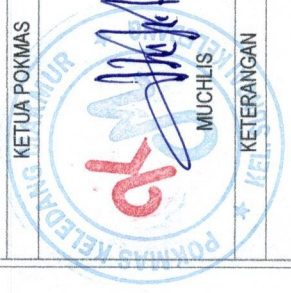

Semenisasi Lapangan Panjang 12 m x 6 m x 0.12 cm

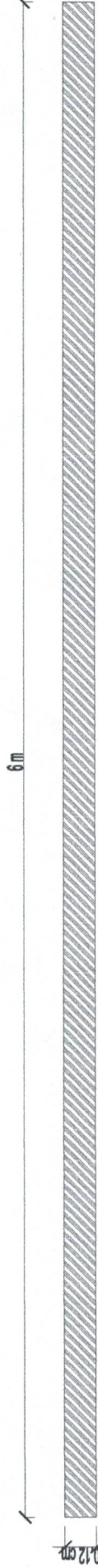
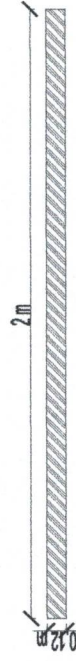

**RENCANA ANGGARAN BELANJA
BIDANG INFRASTRUKTUR**

Kota : Samarinda
Kec : Samarinda seberang
Kel : Sungai Keledang

Kegiatan : Pos PMK & MCK
Volume : 3 x 3 x 2.5 & 3 x 3 m
23 M3 & 9 M3
Lokasi RT : 18, Jl. B. Tomo Gg. Rahmat

NO	URAIAN PEKERJAAAN	SAT	VOL	HARGA SATUAN		TOTAL HARGA
1	Upah					
	1. Tukang	HOK	20,00	Rp	150.000	Rp 3.000.000
	2. Pekerja (2 orang)	HOK	38,00	Rp	110.000	Rp 4.180.000
					TOTAL UPAH	Rp 7.180.000
2	Bahan					
	1. Balok Ulin 8/8 x 400	Batang	25,00	Rp	168.000	Rp 4.200.000
	2. Balok Ulin 5/10 x 400	Batang	30,00	Rp	132.000	Rp 3.960.000
	3. Balok Ulin 4/8 x 400	M3	0,50	Rp	6.600.000	Rp 3.300.000
	4. Balok Meranti 5/7 x 400	Batang	16,00	Rp	49.000	Rp 784.000
	5. Papan Lantai Ulin 2/16 x 400	M3	1,00	Rp	6.600.000	Rp 6.600.000
	6. Papan Lisplank 400	Buah	4,00	Rp	185.000	Rp 740.000
	6. Kayu Lambersiring 200	Batang	60,00	Rp	42.000	Rp 2.520.000
	7. Kunci	Buah	2,00	Rp	283.800	Rp 567.600
	8. Closed duduk	Buah	1,00	Rp	200.000	Rp 200.000
	9. Engsel Pintu	Buah	8,00	Rp	60.000	Rp 480.000
	10. Paku (2, 3, 4)	Kg	15,12	Rp	26.000	Rp 393.000
	11. Atap seng BJLS 40 (80 x 180)	Lbr	6,00	Rp	48.000	Rp 288.000
	12. Paku payung	Kg	0,50	Rp	48.500	Rp 24.250
	13. Baut 3/8 (10 & 15)	kg	12,50	Rp	35.000	Rp 437.500
					Sub Total Bahan (1)	24.494.350
					Jumlah Total biaya (1 + 2)	Rp 31.674.350
					Pembulatan	Rp 31.675.000

Menyetujui
Lurah Sungai Keledang

RAHMADI
NIP.19820831 200502 1 004

Pendamping

NOOR QALBI

Pokmas Keledang Makmur
Ketua



MUHLIS

SUNGAI MAHAKAM

LOKASI PEKERJAAN POS PEMADAM & MCK
(3 m x 3 m x 2.5 m)

GG. RAHMAT

65,30 m

MAHAKAM ELECTRONIK

POS PEMADAM & MCK RT 18

JALAN BUNG TOMO

JALAN BUNG TOMO



POKMAS KELEDANG MAKMUR

KEGIATAN

PEMEBERDAYAAN KELURAHAN

SUB KEGIATAN

PEMBANGUNAN SARANA DAN PRASARANA KELURAHAN

PEKERJAAN

POS PEMADAM + MCK
3 x 3 x 2.5

LOKASI

JL. BUNG TOMO GG. RAHMAT
RT. 18

MENGETAHUI / MENYETUJUI

LURAH SUNGAI KELEDANG

RAHMADI, S.P.

NIP 19820831 200502 1 004

TENAGA PENDAMPING

NOOR QALBI

KETUA POKMAS



MUGHLIS

KETERANGAN

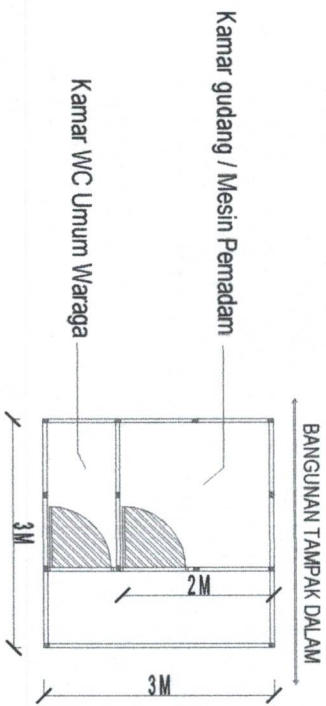

Kamar gudang / Mesin Pemadam

Kamar WC Umum Waraga

BANGUNAN TAMPAK DALAM

Atap Seng Gelombang Kecil 3 m

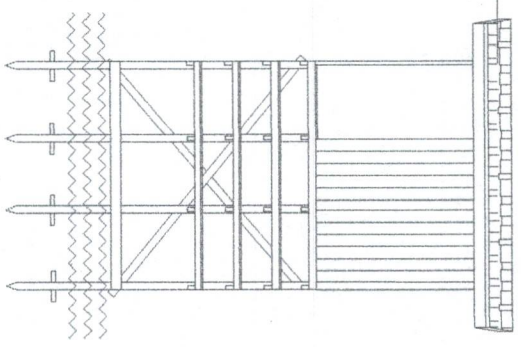

BANGUNAN TAMPAK SAMPIING 2

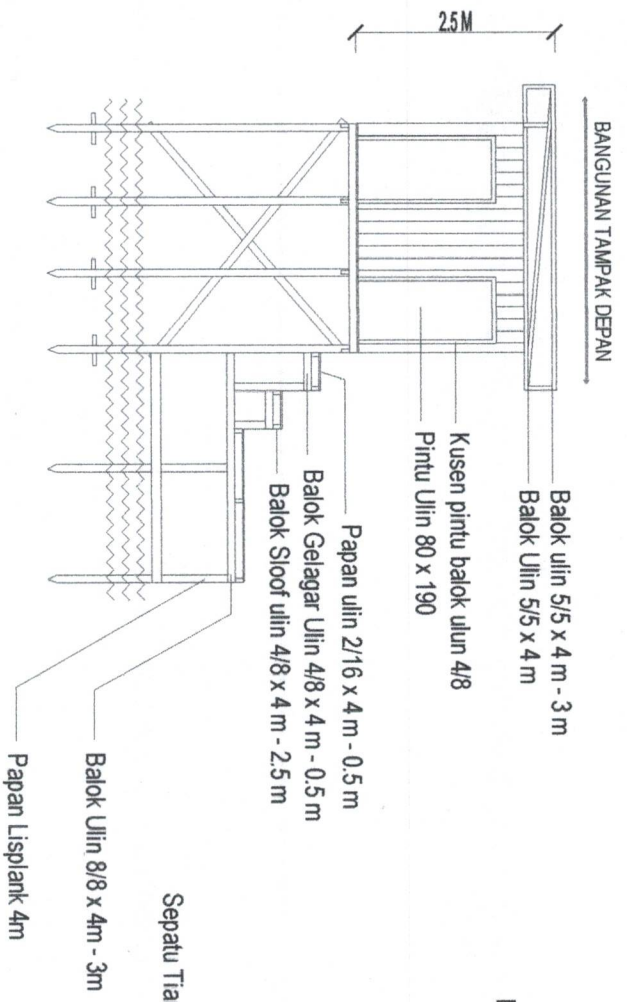

BANGUNAN TAMPAK DEPAN

Balok ujin 5/5 x 4 m - 3 m
Balok Ulin 5/5 x 4 m
Kusen pintu balok ulun 4/8
Pintu Ulin 80 x 190
Papan ulin 2/16 x 4 m - 0.5 m
Balok Gelagar Ulin 4/8 x 4 m - 0.5 m
Balok Sloof ulin 4/8 x 4 m - 2.5 m
Balok Ulin 8/8 x 4m - 3m
Papan Lisplank 4m

Atap Seng Gelombang Kecil 3 m

Papan Lisplank 4m
Tiang Sudut ulin 8/8 x 3m
Papan Dinding Kayu Ulin Lumbersiring
Balok Ulin balant 4/8 x 3m
Tiang Bantu Ulin 4/8 x 3m
Sloof balok Ulin 4/8 x 4m
Gelagar ulin 8/8 x 4m
Balok Suai / Penahan ulin 4/8 x 4m
Tiang Pancang Balok Ulin 8/8 x 4m
Sepatu Tiang Pancang Balok Ulin 4/8 x 4m - 0.4m

BANGUNAN TAMPAK SAMPIING 1

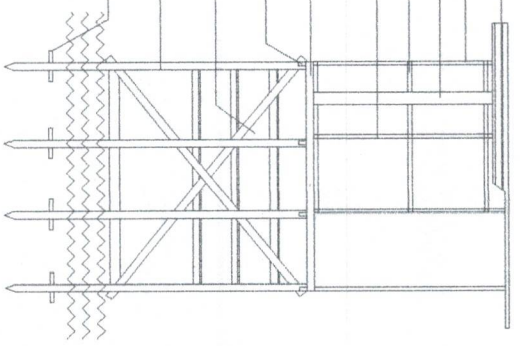

POKMAS KELEDANG MAKMUR

KEGIATAN

PEMBERDAYAAN KELURAHAN

SUB KEGIATAN

PEMBANGUNAN SARANA DAN PRASARANA KELURAHAN

PEKERJAAN

POS BALAKAR & MCK

3 M x 3 M

LOKASI

JL. BUNG TOMO GG. RAHMAT RT. 18

MENGETAHUI / MENYETUJUI

LURAH SUNGAI KELEDANG

RAHMADI, S.P.

NIP 19820831 200502 1 004

TENAGA PENDAMPING

(Signature)

NOOR QALBI

KETUA POKMAS



**RENCANA ANGGARAN BELANJA
BIDANG INFRASTRUKTUR**

Kota : Samarinda
Kel : Samarinda seberang
Kec : Sungai Keledang

Kegiatan : Semenisasi (Beton K 225)
Volume : 20 x 1 x 0.12

2.4 M3

Lokasi RT : 18, Jl. B. Tomo Gg. Rahmat

NO	URAIAN PEKERJAAAN	SAT	VOL	HARGA SATUAN		TOTAL HARGA
1	Upah					
	1. Tukang	HOK	2,00	Rp	150.000	Rp 300.000
	2. Pekerja (2 orang)	HOK	7,00	Rp	110.000	Rp 770.000
	Sub Total Upah (1)					Rp 1.070.000
2	Bahan					
	1. Balok 5/7	Batang	11,00	Rp	49.000	Rp 539.000
	2. Paku 2, 3	Kg	1,35	Rp	26.000	Rp 35.000
	3. Plywod 9mm	Lembar	2,00	Rp	120.000	Rp 240.000
	4. Semen 50 kg	Zak	20,00	Rp	65.000	Rp 1.300.000
	5. Batu Pecah 1-2 cm	M3	2,00	Rp	367.500	Rp 735.000
	6. Plastik Cor	m3	40,00		2.750	110.000
	7. Betonmix (Cairan Cor)	kg	5,00		45.000	225.000
	8. Pasir Mahakam	M3	2,00	Rp	198.000	Rp 396.000
	Sub Total Bahan (2)					Rp 3.580.000
3	Alat Bantu					
	1. Drum Plastik Sedang	buah	1,00		250.000	250.000
	2. Sewa Molen	Jam	10,00	Rp	367.000	Rp 3.670.000
	Sub Total Alat Bantu (3)					Rp 3.670.000
	Jumlah Total biaya (1 + 2 + 3)					Rp 8.320.000
	Pembulatan					Rp 8.320.000

Menyetujui
Lurah Sungai Keledang

RAHMADI
NIP.19820831 200502 1 004

Pendamping



NOOR QALBI

Pokmas Keledang Makmur
Ketua



MUCHLIS



LOKASI PEKERJAAN SEMENISASI
(20 m x 1 m x 0.12 m)

GANG RAHMAT

3300m

JALAN BUNG TOMO

SEMENISASI RT 18

JALAN BUNG TOMO



POKMAS KELEDANG MAKMUR

KEGIATAN

PEMBERDAYAAN KELURAHAN

SUB KEGIATAN

PEMBANGUNAN SARANA DAN PRASARANA KELURAHAN

PEKERJAAN

SEMENISASI
20 x 1 x 0.12

LOKASI

JL. BUNG TOMO GG. RAHMAT
RT. 18

MENGETAHUI / MENYETUJUI

LURAH SUNGAI KELEDANG

RAHMADI, S.P.
NIP. 19820831 200502 1 004

TENAGA PENDAMPING

NOOR QALBI

KETUA POKMAS

MUCHLIS

KETERANGAN





POKMAS KELEDANG MAKMUR

KEGIATAN

PEMBERDAYAAN KELURAHAN

SUB KEGIATAN

PEMBANGUNAN SARANA DAN PRASARANA KELURAHAN

PEKERJAAN

SEMENISASI GANG
20 x 1 x 0.12

LOKASI

JL. BUNG TOMO GG. RAHMAT
RT. 18

MENGETAHUI / MENYETUJUI

LURAH SUNGAI KELEDANG

RAHMADI, S.P.
NIP.19820831 200502 1 004

TENAGA PENDAMPING

NOOR QALBI

KETUA POKMAS

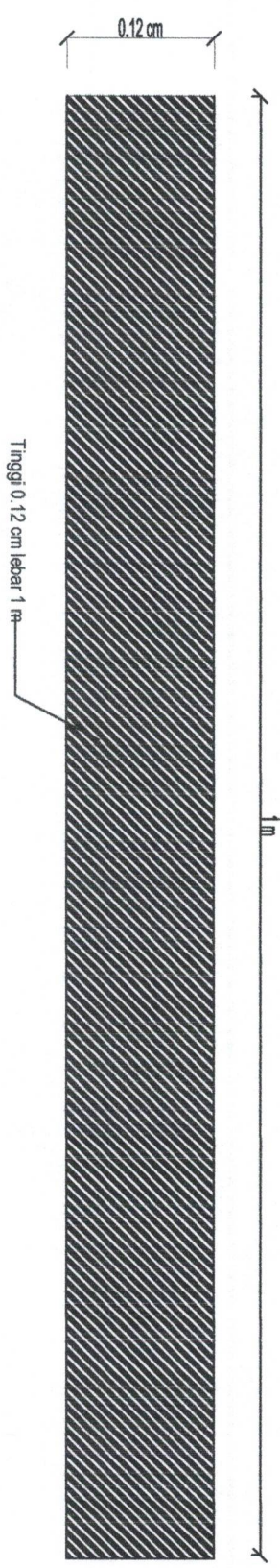
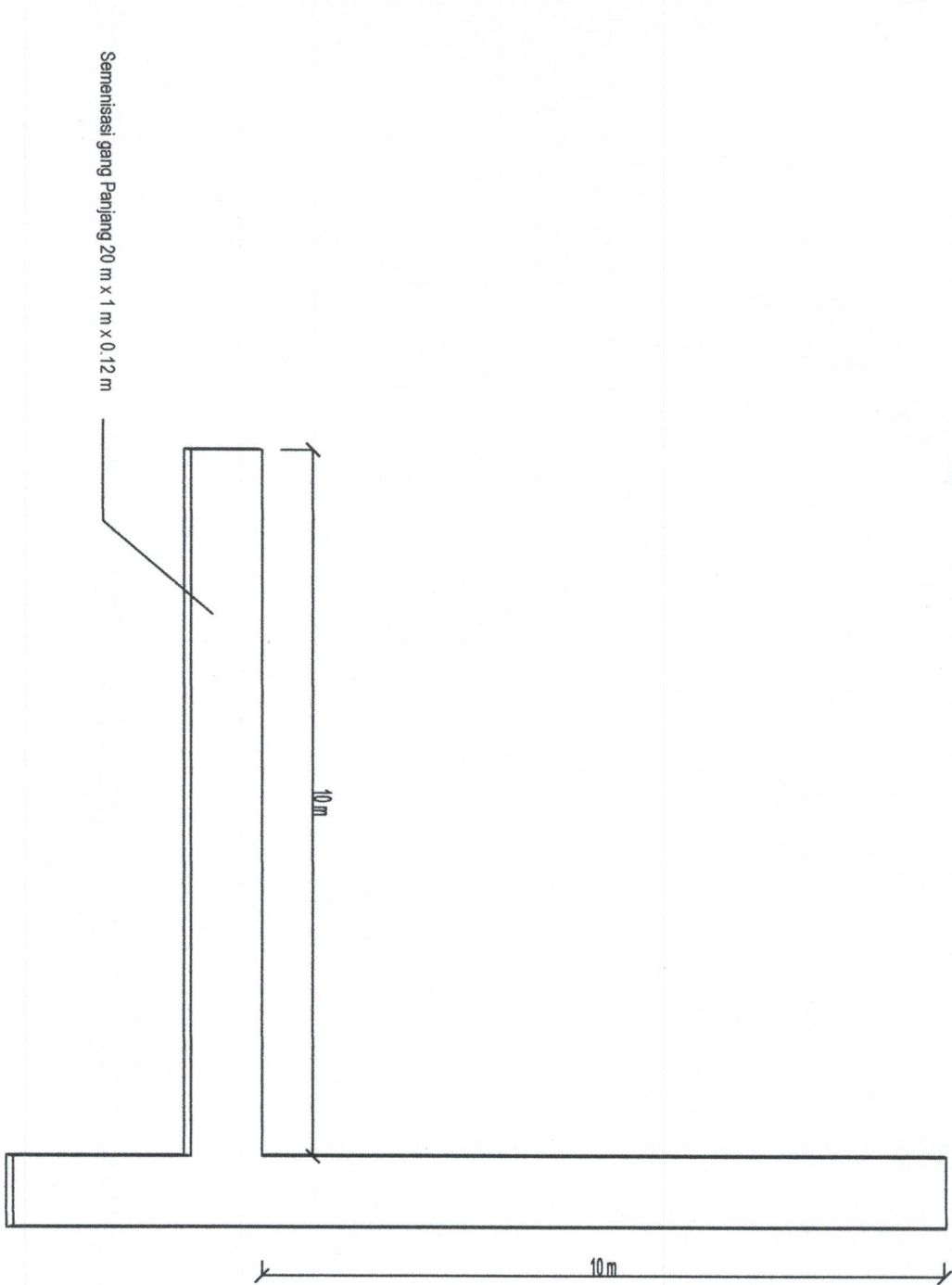
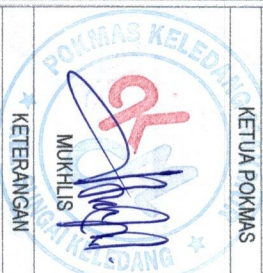

**RENCANA ANGGARAN BELANJA
BIDANG INFRASTRUKTUR**



Kota : Samarinda
Kec : Samarinda seberang
Kel : Sungai Keledang

Kegiatan : Gorong Gorong
Volume: 7 x 0.8 x 1

5.6 M3

Lokasi RT: 19, Perum. Keledang Mas

NO	URAIAN PEKERJAAAN	SAT	VOLUME	HARGA SATUAN	TOTAL HARGA
1	Upah				
	1. Tukang (2 orang)	OH	11,00	150.000	1.650.000
	2. Pekerja (2 orang)	OH	25,00	110.000	2.750.000
Sub Total Upah (1)					4.400.000
2	Bahan				
	1. Pasir	M3	4,00	198.000	792.000
	2. Batu Pecah 1-2 cm	M3	6,00	367.500	2.205.000
	3. Semen 50 kg	M3	45,00	65.000	2.925.000
	4. Besi beton @10 x 12.0 m	Btg	46,00	68.200	3.137.200
	5. Bendrat	Kg	4,50	27.500	123.750
	6. Paku	Kg	5,33	26.000	138.550
	7. Balok 5/7	M3	38,00	45.000	1.710.000
	8. Plywod 9 mm	Lbr	5,50	126.500	695.750
	9. Air cor	Ls	1,00	125.000	125.000
Sub Total bahan (2)					11.852.250
3	Alat				
	1. Mesin Molen	Jam	7,50	367.500	2.756.250
Sub Total alat (3)					2.756.250
Jumlah Total biaya (1 + 2 + 3)					19.008.500
Total					19.008.500

Menyetujui Lurah Sungai Keledang RAHMADI NIP.19820831 200502 1 004	Pendamping  NOOR QALBI	POKMAS KELEDANG MAKMUR Ketua  MUCHLIS 
---------------------------------------------------------------------------------	-------------------------------------------------------------------------------------------------------------------------	----------------------------------------------------------------------------------------------------------------------------------------------------------------------------------------------------------------------------------



POKMAS KELEDANG MAKMUR

KEGIATAN

PEMBERDAYAAN KELURAHAN

SUB KEGIATAN

PEMBANGUNAN SARANA DAN PRASARANA KELURAHAN

PEKERJAAN

GORONG GORONG

6 x 0,8 x 0,85

LOKASI

PERUM. KELEDANG MAS

RT. 19

MENGETAHUI / MENSETUJUI

LURAH SUNGAI KELEDANG

RAHMADI, S.P.

NIP. 19820831 200502 1 004

TENAGA PENDAMPING

NOOR QLBI

KETUA POKMAS

MUCHLIS

KETERANGAN

LOKASI PEKERJAAN GORONG GORONG
PERUM. KELEDANG MAS BARU RT 19
6 x 0,8 x 0,85

7.70

BLOK BT

YAYASAN NURUL IHSAN

SANITAKARYA MOEDA
BEKARYA, PT

BLOK BU

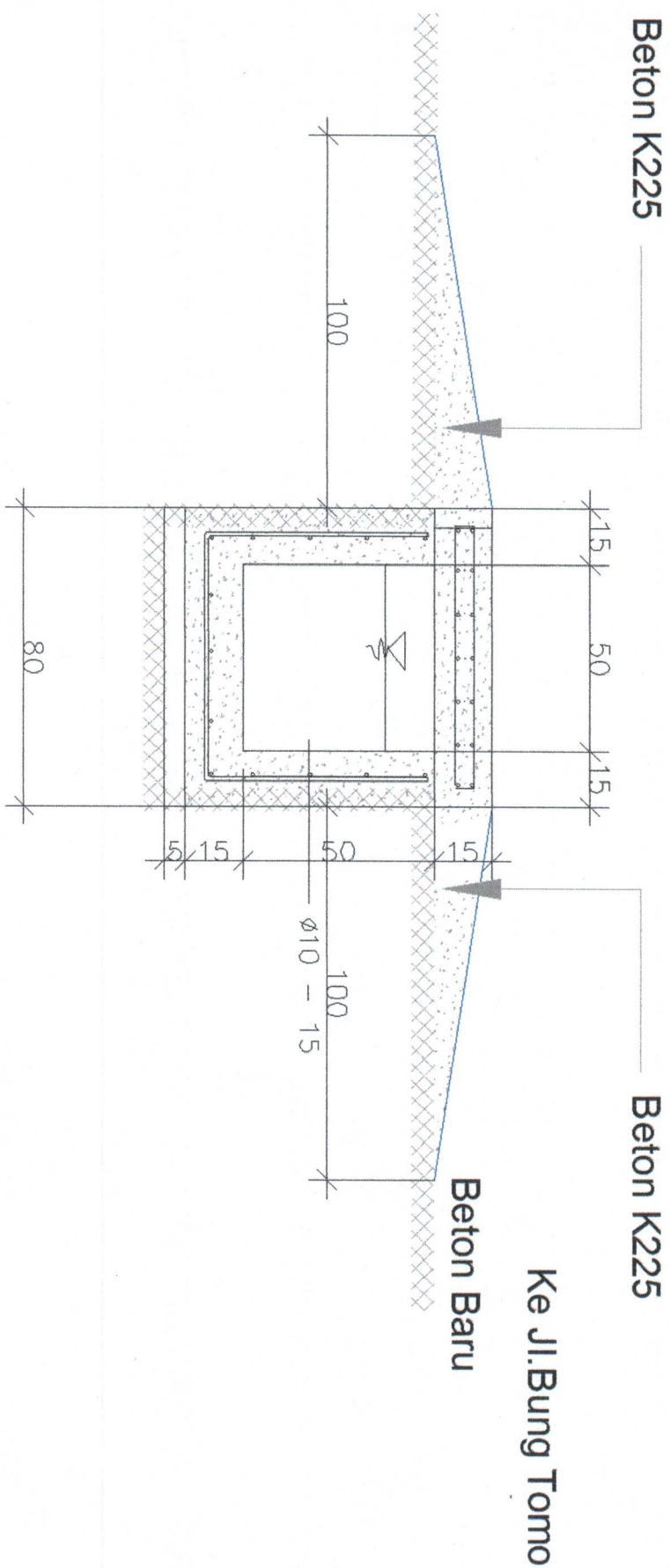

POKMAS KELEDANG MAKMUR

KEGIATAN

PEMBERDAYAAN KELURAHAN

SUB KEGIATAN

PEMBANGUNAN SARANA DAN PRASARANA KELURAHAN

PEKERJAAN

PEMBUATAN GORONG-GORONG
7 x 0.8 x 0.85

LOKASI

PERUM. KELEDANG MAS
RT. 19

MENGETAHUI / MENYETUJUI

LURAH SUNGAI KELEDANG

RAHMADI, S.P.
NIP. 19820831 200502 1 004

TENAGA PENDAMPING

NOOR QALBI

KETUA POKMAS





**RENCANA ANGGARAN BELANJA
BIDANG INFRASTRUKTUR**

Kota : Samarinda
Kec : Samarinda seberang
Kel : Sungai Keledang

Kegiatan : Drainase
Volume: 40 x 0.80 x 0.55

18 M3

Lokasi RT: 19 (Perum Keledang Mas)

NO	URAIAN PEKERJAAAN	SAT	VOLUME	HARGA SATUAN	TOTAL HARGA
1	Bahan				
	1. Ulin 8x8 -200	M3	26,00	Rp 84.000	Rp 2.184.000
	2. Pasir Mahakam,	M3	13,00	Rp 198.000	Rp 2.574.000
	3. Batu Pedas	M3	27,00	Rp 315.700	Rp 8.523.900
	4. Semen 50 kg	Zak	73,00	Rp 75.000	Rp 5.475.000
	5. Kayu Balok 5/7 x 4 m	M3	28,00	Rp 48.500	Rp 1.358.000
	Sub total Bahan (1)				Rp 20.114.900
2	Upah				
	1. Tukang	OH	30,00	Rp 150.000	Rp 4.500.000
	3. Pekerja (2 orang)	OH	15,00	Rp 110.000	Rp 1.650.000
	Sub total upah (2)				Rp 6.150.000
	Jumlah Total biaya (1 + 2)				Rp 26.264.900
	Pembulatan				Rp 26.265.000
	Menyetujui Lurah Sungai Keledang RAHMADI NIP.19820831 200502 1 004	Pendamping  NOOR QALBI	POKMAS KELEDANG MAKMUR Ketua  		



POKMAS KELEDANG MAKMUR

KEGIATAN

PEMBERDAYAAN KELURAHAN

SUB KEGIATAN

PEMBANGUNAN SARANA DAN PRASARANA KELURAHAN

PEKERJAAN

PARIT
40 x 0.8 x 0.55

LOKASI

PERUM. KELEDANG MAS
RT. 19

MENGETAHUI / MENYETUJUI

LURAH SUNGAI KELEDANG

RAHMADI, S.P.

NIP 19820831 200502 1 004

TENAGA PENDAMPING

NOOR QALBI

KETUA POKMAS



MUCHLIS

KETERANGAN

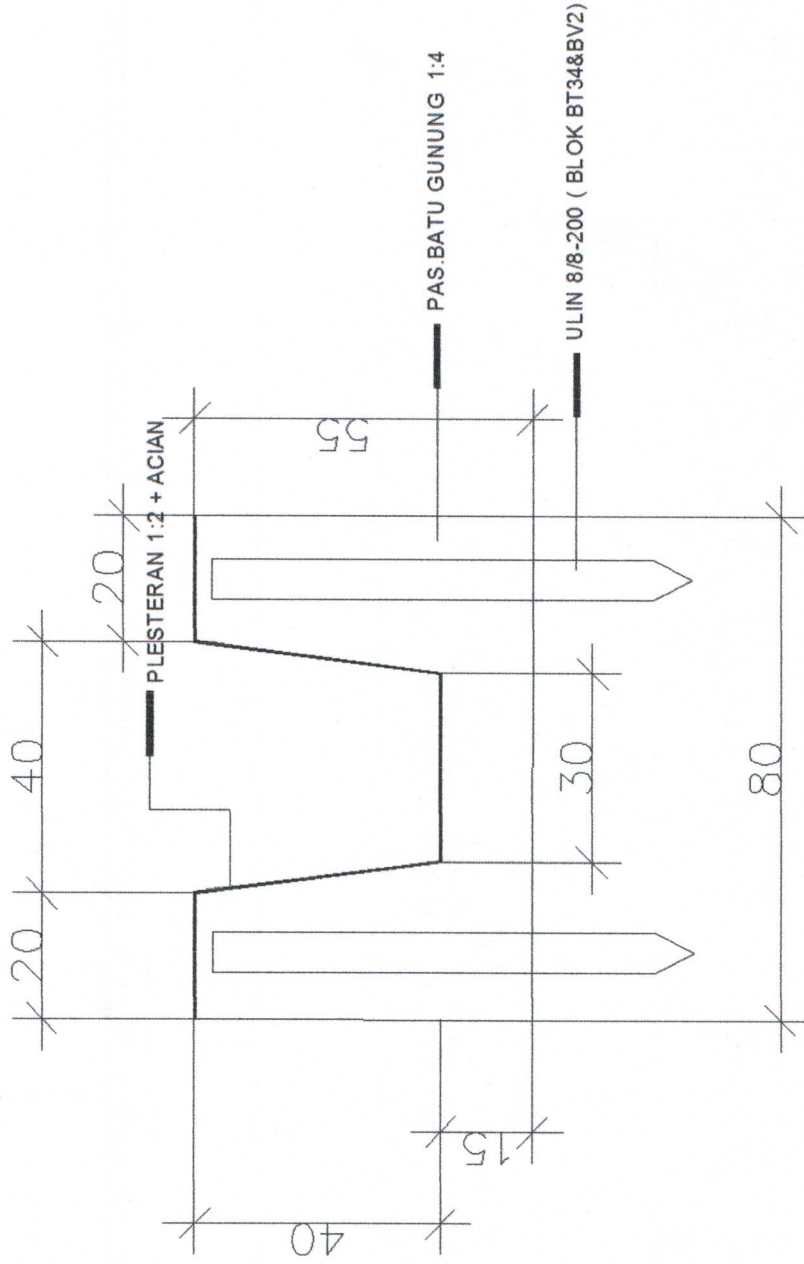



POKMAS KELEDANG MAKMUR

KEGIATAN

PEMBERDAYAAN KELURAHAN

SUB KEGIATAN

PEMBANGUNAN SARANA DAN PRASARANA KELURAHAN

PEKERJAAN

PARIT

40 x 0.8 x 0.55

LOKASI

PERUM. KELEDANG MAS
RT. 19

MENGETAHUI / MENYETUJUI

LURAH SUNGAI KELEDANG

RAHMADI, S.P.

NIP 19820831 200502 1 004

TENAGA PENDAMPING

NOOR QALBI

KETUA POKMAS





**RENCANA ANGGARAN BELANJA
BIDANG INFRASTRUKTUR**

Kota : Samarinda
Kec : Samarinda seberang
Kel : Sungai Keledang

Kegiatan : Drainase (Beton K 150)
Volume : 20 m x 0.6 m x 1.10 m
13,2 M3

Lokasi RT : 20, Perum. Keledang Mas

NO	URAIAN	SAT	VOL	HARGA SATUAN	TOTAL HARGA
1	2	3	4	5	6
1	UPAH KERJA				
	1. Tukang	OH	4,00	Rp 150.000	600.000
	2. Pekerja (2 orang)	OH	22,00	Rp 110.000	2.420.000
	Sub Total Upah (1)				3.020.000
2	BAHAN				
	1. Semen 50 kg	Zak	83,00	65.000	5.395.000
	2. Batu Gunung	M3	3,50	750.000	2.625.000
	3. Pasir Mahakam	M3	8,00	198.000	1.584.000
	4. Batu Pecah 1 , 2 cm	M3	10,01	367.500	3.680.000
	5. Paralon 3' inc	Batang	1,00	180.000	180.000
	6. kayu 8/8 x 4m - 3m	M3	4,00	185.000	740.000
	7. Tanah uruk	M3	2,00	150.000	300.000
	Sub Total Bahan (2)				14.504.000
	Jumlah Total biaya (1 + 2 + 3)				17.524.000
	Total				17.524.000
	Menyetujui Lurah Sungai Keledang RAHMADI NIP.19820831 200502 1 004	Pendamping  NOOR QALBI	POKMAS KELEDANG MAKMUR Ketua  MUCHLIS 		

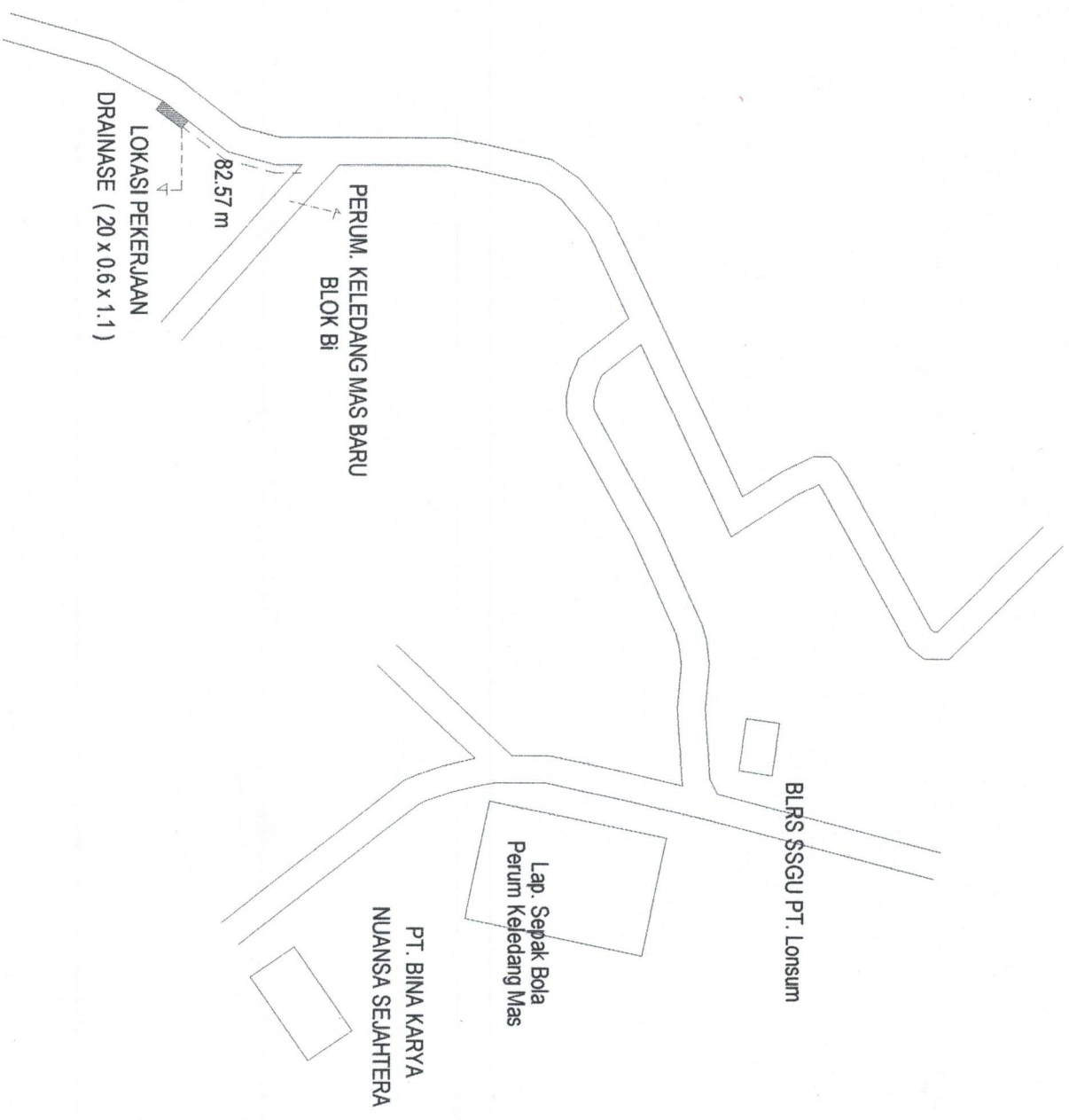

DRAINASE RT 20



POKMAS KELEDANG MAKUR

KEGIATAN

PEMBERDAYAAN KELURAHAN

SUB KEGIATAN

PEMBANGUNAN SARANA DAN PRASARANA KELURAHAN

PEKERJAAN

DRAINASE
20 x 0.6 x 1.1

LOKASI

PERUM. KELEDANG MAS
RT. 20

MENGETAHUI / MENYETUJUI

LURAH SUNGAI KELEDANG

RAHMADI, S.P.
NIP. 19820831 200502 1 004

TENAGA PENDAMPING

NOOR QALBI

KETUA POKMAS



KETERANGAN

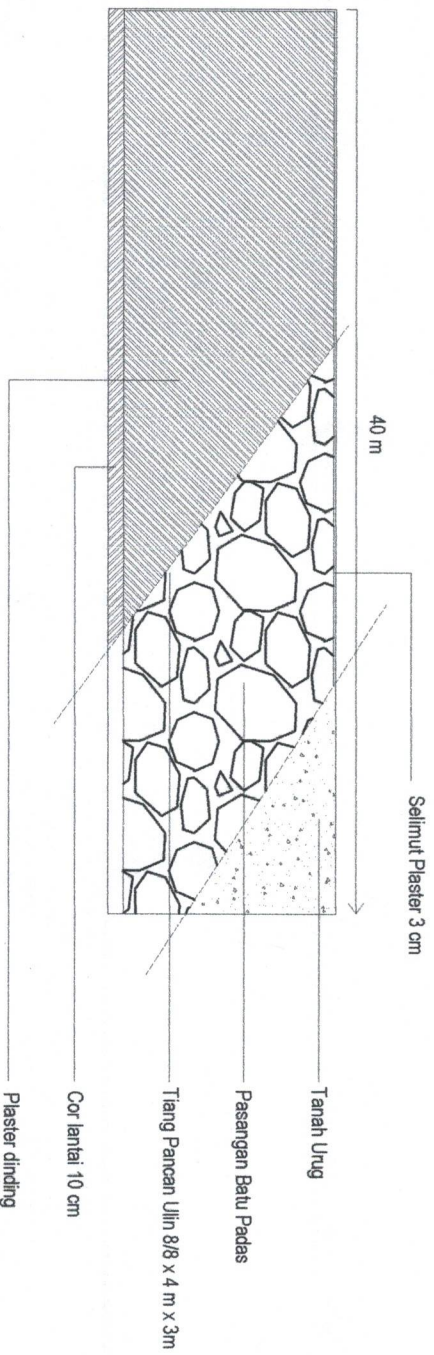
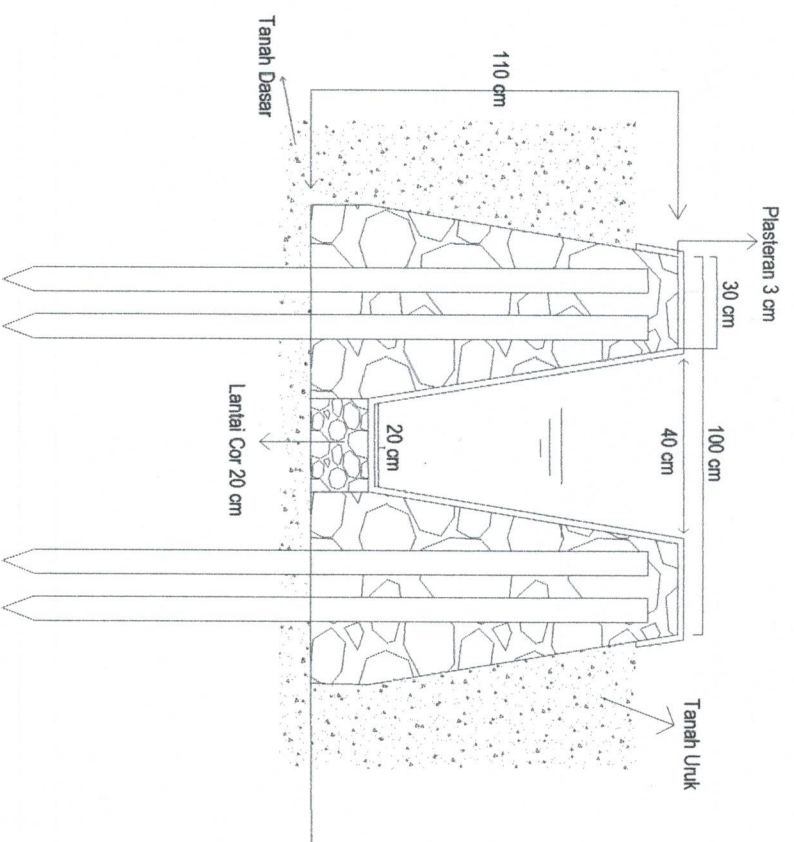

POKMAS KELEDANG MAKMUR

KEGIATAN

PEMBERDAYAAN KELURAHAN

SUB KEGIATAN

PEMBANGUNAN SARANA DAN PRASARANA KELURAHAN

PEKERJAAN

PEMBUATAN DRAINASE
20 x 0,6 x 1,10

LOKASI

PERUM KELEDANG MAS
RT. 20

MENGETAHUI / MENYETUJUI

LURAH SUNGAI KELEDANG

RAHMADI, S.P.

NIP. 19820831 200502 1 004

TENAGA PENDAMPING

NOOR QALBI

KETUA POKMAS



MUCHLIS

KETERANGAN



**RENCANA ANGGARAN BELANJA
BIDANG INFRASTRUKTUR**

Kota : Samarinda
Kec : Samarinda seberang
Kel : Sungai Keledang

Kegiatan : Balai RT
Volume : 5 x 3 x 3.5

53 M3

Lokasi RT : 21, Perum Keledang Mas

NO	URAIAN	SAT	VOL	HARGA SATUAN	TOTAL HARGA
1	2	3	4	5	6
1	UPAH KERJA				
	1. Tukang (2 orang)	OH	40,00	Rp 150.000	6.000.000
	2. Pekerja (2 orang)	OH	30,00	Rp 110.000	3.300.000
	Sub Total Upah (1)				9.300.000
	BAHAN				
2	1. Papan Dinding Lambersiring 4 m	Lembar	210,00	45.000	9.450.000
	2. Papan Lantai Ulin 2/16 x 4 m	M3	60,00	85.000	5.100.000
	3. Balok ulin 8/8 x 4m	Batang	30,00	168.000	5.040.000
	4. Balok Ulin 4/8 x 4 m	Batang	70,00	85.000	5.950.000
	5. Balok Meranti 5/7 x 4m	Batang	50,00	49.000	2.450.000
	6. Papan Lisplang	Buah	9,00	185.000	1.665.000
	7. Atap Sakura Roof	Lembar	45,00	42.000	1.890.000
	8. Pintu Bengkirai 40 x 190	M3	4,00	850.000	3.400.000
	9. Pegangann Pintu	Buah	2,00	183.750	367.500
	10. Engsel Jendela (stenlis 3")	Buah	6,00	49.350	296.100
	11. Engsel pintu (Stenlis 5")	Buah	8,00	69.000	552.000
	12. Paku 2,3,4 inc	Kg	9,00	26.000	234.000
	13. Pasir	M3	1,00	198.000	198.000
	14. Semen	Zak	7,00	65.000	455.000
	15. Tanah Uruk	M3	1,00	250.000	250.000
	16. Batu Gunung	M3	2,00	750.000	1.500.000
	Sub Total Bahan (2)				38.797.600
	Jumlah Total biaya (1 + 2)				48.097.600
	Pembulatan				48.098.000
	Total				48.098.000
	Menyetujui Lurah Sungai Keledang RAHMADI NIP.19820831 200502 1 004	Pendamping  NOOR QALBI	POKMAS KELEDANG MAKMUR Ketua  MUCHLIS 		



POKMAS KELEDANG MAKAMUR

KEGIATAN

PEMBERDAYAAN KELURAHAN

SUB KEGIATAN

PEMBANGUNAN SARANA DAN PRASARANA KELURAHAN

PEKERJAAN

BALAI RT
5 x 3

LOKASI

PERUM. KELEDANG MAS
RT. 21

MENGETAHUI / MENYETUJUI

LURAH SUNGAI KELEDANG

RAHMADI, S.P.

NIP. 19820831 200502 1 004

TENAGA PENDAMPING

NOOR QALBI

KETUA POKMAS



KEJAKSAAN TINGGI KALIMANTAN TIMUR

PERUM KELEDANG MAS

LAP. BOLA PERUM KELEDANG MAS

1800 m

LOKASI PEKERJAAN
BALAI RT = 5 x 3

BALAI RT 21

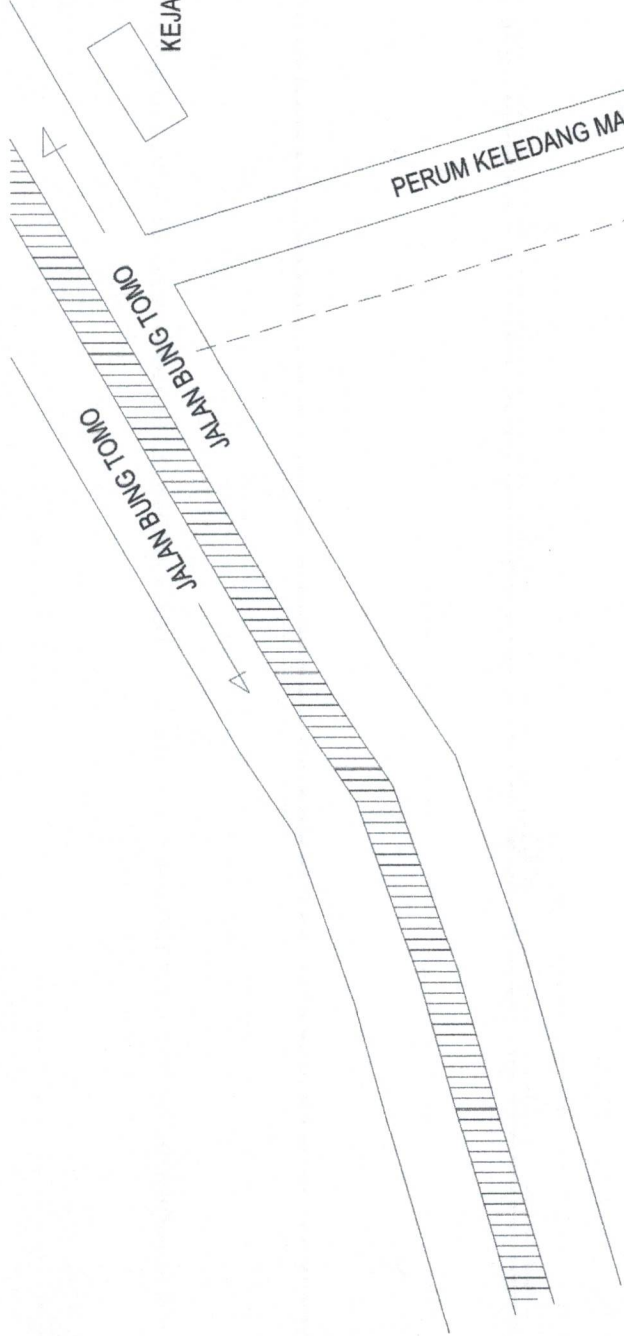

BANGUNAN TAMPAK DEPAN

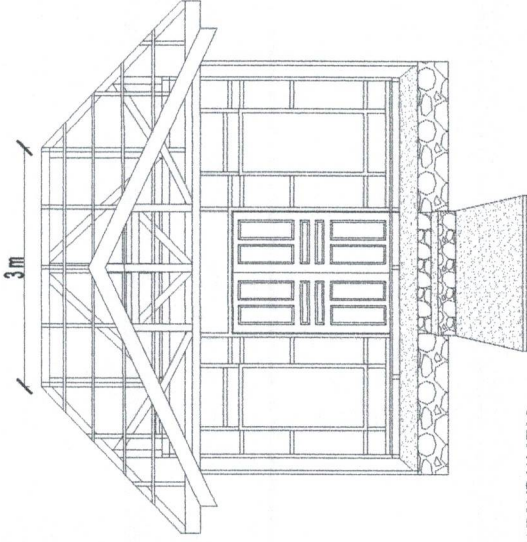
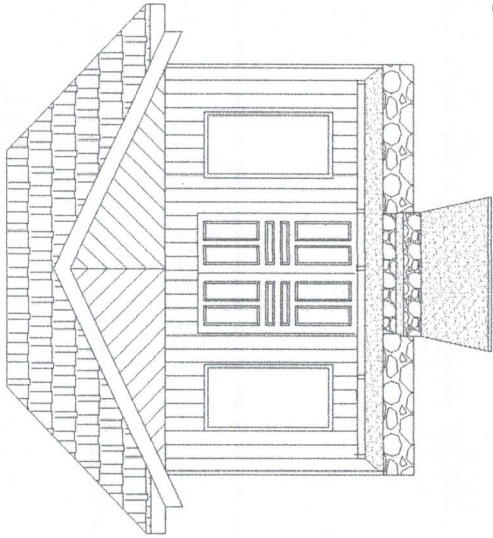

3m

BANGUNAN TAMPAK DALAM

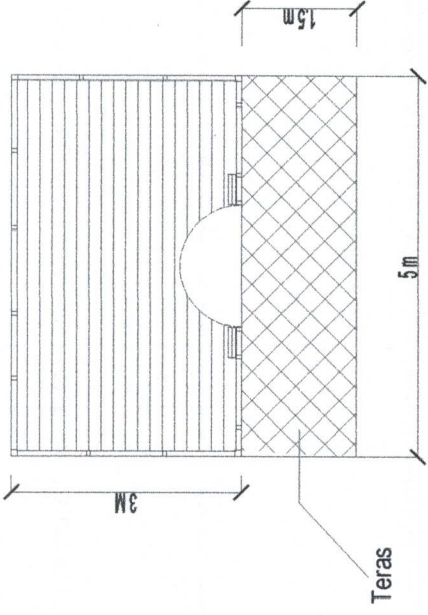

3m

Teras

5m

1.5m

BANGUNAN TAMPAK ATAS

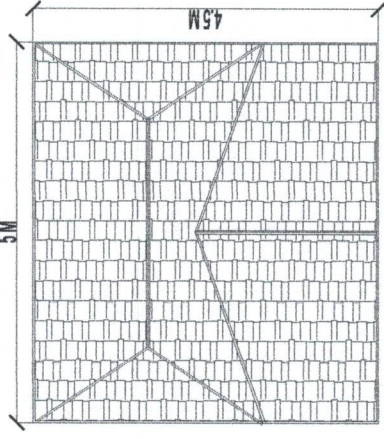

5m

4.5m

BANGUNAN TAMPAK SAMPING

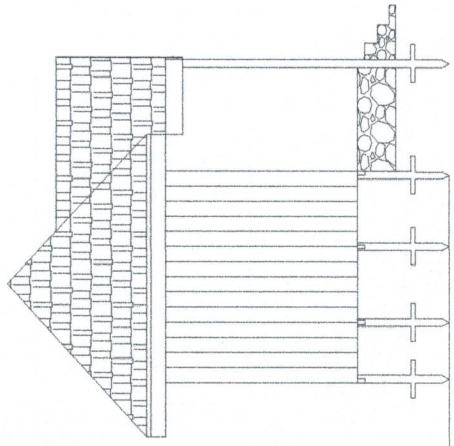

Kusen pintu & Jendela

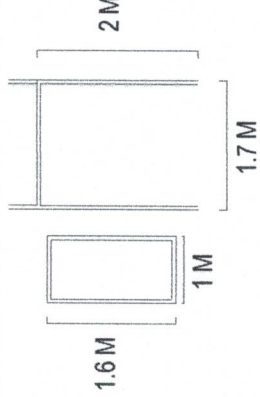

1.6 M

1 M

2 M

1.7 M

Balok kuda kuda meranti 4/8 x 4m

Balok Meranti 4/8 x 4 m

Papan lissplang

Papan dinding meranti

Balok Gelagar Ulin 5/10 x 4m

Balok Ulin 4/8 x 4m

Tiang sudut Ulin 8/8 x 4m - 3m

Pas. Batu padas & cor semen

sepatu tiang pancang 4/8 x 4 m - 0.4

Tiang Pancang Ulin 10/10 x 4m - 3m

Tanah Dasar



POKMAS KELEDANG MAKMUR

KEGIATAN

PEMBERDAYAAN KELURAHAN

SUB KEGIATAN

PEMBANGUNAN SARANA DAN PRASARANA KELURAHAN

PEKERJAAN

PEMBANGUNAN BALAI RT 5 M x 3 M

LOKASI

PERUM KELEDANG MAS RT. 21

MENGETAHUI / MENYETUJUI

LURAH SUNGAI KELEDANG

RAHMADI, S.P.

NIP 19820831 200502 1 004

TENAGA PENDAMPING

(Signature)

NOOR QALBI

KETUA POKMAS



MUCHLIS

KETERANGAN

**RENCANA ANGGARAN BELANJA
BIDANG INFRASTRUKTUR**

Kota : Samarinda
Kel : Samarinda seberang
Kec : Sungai Keledang

Kegiatan : Semenisasi Beton K 225

Volume : 10 x 2.5 x 0.20

5 M3

Lokasi RT : 21, Perum Keledang Mas

NO	URAIAN PEKERJAAAN	SAT	VOL	HARGA SATUAN		TOTAL HARGA
1	Upah					
	1. Tukang	HOK	10,00	Rp	150.000	Rp 1.500.000
	3. Pekerja	HOK	20,00	Rp	110.000	Rp 2.200.000
	Sub Total Upah (1)					Rp 3.700.000
2	Bahan					
	1. Batu Pecah 1 - 2 cm	M3	4,00	Rp	367.500	Rp 1.470.000
	2. Semen 50 kg	Zak	40,00	Rp	65.000	Rp 2.600.000
	3. Pasir Mahakam	M3	6,00	Rp	198.000	Rp 1.188.000
	4. Plywod 9 mm	Lembar	9,00		126.500	1.138.500
	5. Paku 2.3 inc	kg	4,79		26.000	124.500
	6. Betonmix (cairan cor)	kg	5,00		45.000	225.000
	6. Balok 5/7 x 4m	Batang	10,00		45.000	450.000
	Sub Total Bahan (2)					Rp 7.196.000
3	Alat Bantu			Rp		Rp
	1. Sewa Molen	Jam	8,86	Rp	367.500	Rp 3.255.000
	Sub Total Alat bantu (3)					Rp 3.255.000
	Jumlah Total biaya (1 + 2 + 3)					Rp 14.151.000
	Pembulatan					Rp 14.151.000

Menyetujui
Lurah Sungai Keledang

RAHMADI
NIP.19820831 200502 1 004

Pendamping



NOOR QALBI

Pokmas Keledang Makmur
Ketua



MUCHLIS



POKMAS KELEDANG MAKMUR

KEGIATAN

PEMBERDAYAAN KELURAHAN

SUB KEGIATAN

PEMBANGUNAN SARANA DAN PRASARANA KELURAHAN

PEKERJAAN

SEMENISASI

10 x 2.5 x 0.20

LOKASI

PERUM. KELEDANG MAS

RT. 21

MENGETAHUI / MENYETUJUI

LURAH SUNGAI KELEDANG

RAHMADI, S.P.

NIP 19820831 200502 1 004

TENAGA PENDAMPING

NOOR QALBI

KETUA POKMAS



MUCHLIS

KETERANGAN

KEJAKSAAN TINGGI KALIMANTAN TIMUR

PERUM KELEDANG MAS

LAP. BOLA PERUM KELEDANG MAS

1800 m

JALAN BUNG TOMO

JALAN BUNG TOMO

LOKASI PEKERJAAN
SEMENISASI 10 x 2.5 x 0.20

SEMENISASI RT 21



POKMAS KELEDANG MAKMUR

KEGIATAN

PEMBERDAYAAN KELURAHAN

SUB KEGIATAN

PEMBANGUNAN SARANA DAN PRASARANA KELURAHAN

PEKERJAAN

SEMENISASI

10 m x 2.5 m x 0.20 m

LOKASI

PERUM KELEDANG MAS RT. 21

MENGETAHUI / MENYETUJUI

LURAH SUNGAI KELEDANG

RAHMADI, S.P.

NIP. 19820831 200502 1 004

TENAGA PENDAMPING

NOOR QALBI

KETUA POKMAS



KETERANGAN

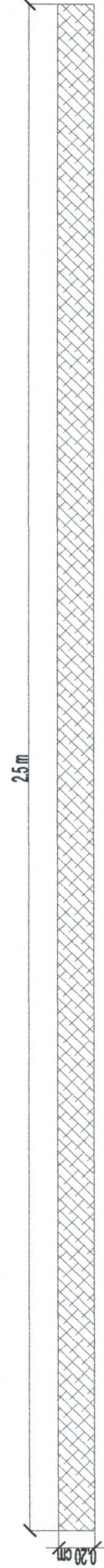
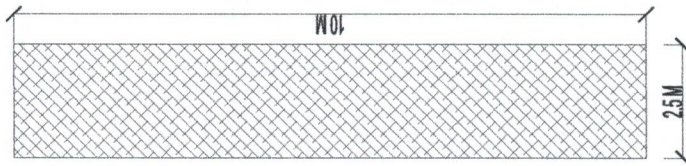

**RENCANA ANGGARAN BELANJA
BIDANG INFRASTRUKTUR**

Kota : Samarinda
Kel : Samarinda seberang
Kec : Sungai Keledang

Kegiatan : POSYANDU TAHAP 1
Volume : 5 x 6 x 3
: 90 M3

Lokasi RT : RT 22 Perum Kledang Mas baru

NO	URAIAN PEKERJAAAN	SAT	VOL	HARGA		TOTAL HARGA
	Posyandu RT 22					
1	Pekerjaan Pondasi					
	1. Pancang Ulin 10/10 x 2 m	M3	9,00	Rp	132.000	Rp 1.188.000
	2. Pasangan Batu 1 : 4					
	a. Pasir Mahakam	M3	4,35	Rp	198.000	Rp 861.300
	b. Semen Tonasa	Zak	27,00	Rp	65.000	Rp 1.755.000
	c. Batu Padas	M3	11,00	Rp	315.700	Rp 3.472.700
	Sub Total (1)					7.277.000
2	Pekerjaan Dinding					-
	1. Tiang Utama Baja Ringan 10/10	Batang	9,00	Rp	280.000	Rp 2.520.000
	2. Rangka besi baja Ringan Memanjang	Batang	21,00	Rp	280.000	Rp 5.880.000
	3. Rangka baja Ringan Kanal Memanjang	Batang	17,00	Rp	280.000	Rp 4.760.000
	4. Ringbalk Baja Ringan (kotak 10/10 x 4 m)	Batang	3,00	Rp	50.000	Rp 150.000
	5. Paku Dril	Kotak	10,00	Rp	40.000	Rp 400.000
	Sub Total (2)					Rp 13.710.000
3	Pekerjaan Atap & Rangka					-
	1. Rangka Atap baja Ringan	M2	36,00	Rp	157.500	Rp 5.670.000
	6. Atap Seng BJLS 30 (66.4 M) (4.5 x 2 x 8)	Lbr	32,00	Rp	77.700	Rp 2.486.400
	8. Papan Lis Plank	M3	15,00	Rp	198.500	Rp 2.977.500
	9. Paku Atap	Kotak	3,00	Rp	30.000	Rp 90.000
	10. Paku Rangka Drill	Kotak	2,00	Rp	50.000	Rp 100.000
	Sub Total (3)					Rp 11.323.900
4	Pasangan Pintu + Jendela					-
	1. Kusen Jendela	M3	23,77	Rp	75.000	Rp 1.782.750
	2. Kusen Pintu	M3	10,40	Rp	75.000	Rp 780.000
	Sub Total (4)					Rp 2.562.750
5	Upah					-
	1. Tukang		35,00	Rp	150.000	Rp 5.250.000
	2. Pekerja		30,00	Rp	110.000	Rp 3.300.000
	Sub Total (5)					Rp 8.550.000
	Jumlah Total Biaya (1 + 2 + 3 + 4 + 5)					Rp 43.423.650
	Pembulatan					Rp 43.424.000

Menyetujui
Lurah Sungai Keledang

RAHMADI
NIP.19820831 200502 1 004

PENDAMPING



NOOR QALBI





POKMAS KELEDANG MUKMUR

KEGIATAN

PEMBERDAYAAN KELURAHAN

SUB KEGIATAN

PEMBANGUNAN SARANA DAN PRASARANA KELURAHAN

PEKERJAAN

POSYANDU TAHAP 1

6 m x 5 m

LOKASI

PERUM KELEDANG MAS

RT. 22

MENGETAHUI / MENYETUJUI

LURAH SUNGAI KELEDANG

RAHMADI, S.P.

NIP. 19820831 200502 1 004

TENAGA PENDAMPING

NOOR CALBI

KETUA POKMAS

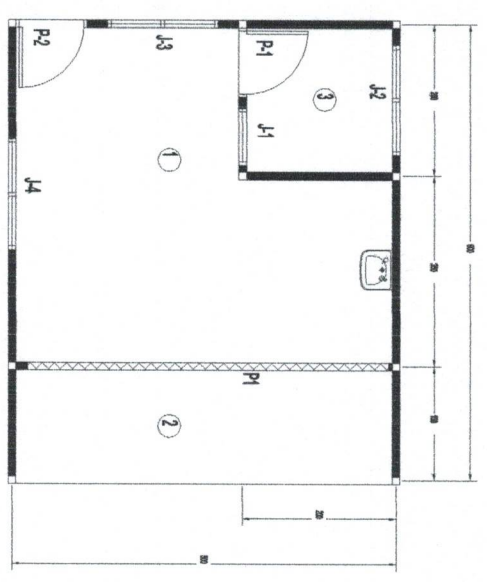

GEJUNG SERBA GUNA RT 22

Keterangan Simbol :

- 1. Ruang Utama
 - Tempat Rezek
 - Tempat Tidur Tamu/Keluarga
 - Tempat Meja Beserta
- 2. Toilet
 - Tempat Kegiatan Posyandu
 - Tempat Beristirahat Anak-Anak
- 3. Ruang Penyimpanan
 - Tempat Penyimpanan Alat-Alat Berang
 - Tempat Penyimpanan Dokumen
- 4. P = Pintu, P1 s.d P2
 - J = Jendela, J1 s.d J4
 - P1 = Pintu, Rolling Door

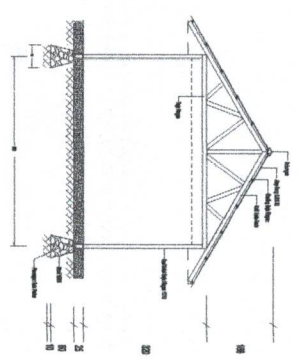
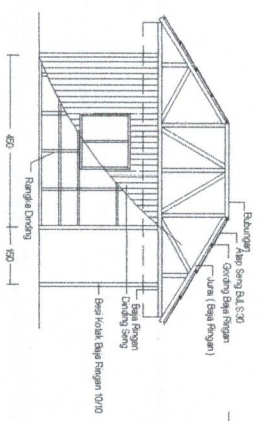
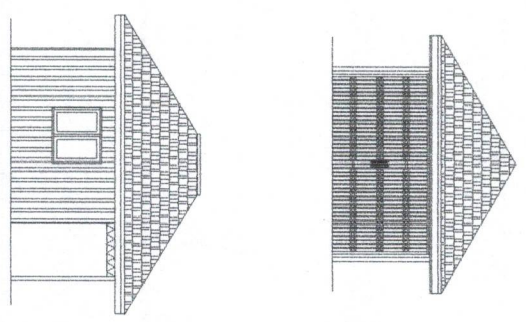
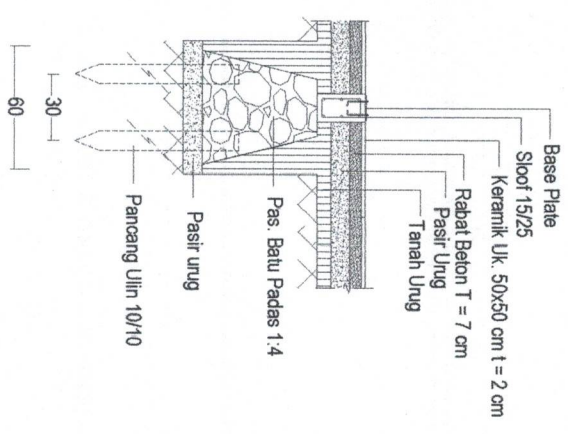

MAJELIS TALIM
RAUDHATUSSALAM

GANG SURYA INDAH

MESS PT NASS

185.47 m

LOKASI PEKERJAAN POSYANDU
6 m x 5 m x 3 m



POKMAS KELEDANG MAKMUR

KEGIATAN

PEMEBERDAYAAN KELURAHAN

SUB KEGIATAN

PEMBANGUNAN SARANA DAN
PRASARANA KELURAHAN

PEKERJAAN

POSYANDU TAHAP 1
6 m x 5 m

LOKASI

PERUM. KELEDANG MAS
RT. 22

MENGETAHUI / MENYETUJUI

LURAH SUNGAI KELEDANG

RAHMADI, S.P.

NIP. 19820831 200502 1 004

TENAGA PENDAMPING

NOOR GALBI

KETUA POKMAS



MUGHILIS

KETERANGAN



**RENCANA ANGGARAN BELANJA
BIDANG INFRASTRUKTUR**

Kota : Samarinda
Kel : Samarinda seberang
Kec : Sungai Keledang

Kegiatan : Semenisasi
Volume : 40 x 2.5 x 0.25

25 M3

Lokasi RT : 23, Jl. B. Tomo

NO	URAIAN PEKERJAAAN	SAT	VOL	HARGA SATUAN		TOTAL HARGA
1	Bahan					-
	1. Batu Pecah 1 , 2 cm	M3	19,00	Rp	367.500	Rp 6.982.500
	2. Semen 50 kg	Zak	186,00	Rp	65.000	Rp 12.090.000
	3. Pasir Tenggarong	M3	13,00	Rp	251.300	Rp 3.266.900
	4. Kawat Bendrat	kg	3,00	Rp	27.500	Rp 82.500
	5. Plywod 9 mm	Lembar	20,00	Rp	126.500	Rp 2.530.000
	6. Kayu 5/7 x 4 m	Batang	30,00	Rp	45.000	Rp 1.350.000
	7. Plastik Cor	M3	100,00	Rp	2.750	Rp 275.000
	8. BBM solar (mesin Molen)	Liter	80,00	Rp	6.800	Rp 544.000
	9. Paku 2, 3 "	Kg	6,26	Rp	26.000	Rp 162.850
Sub Total Bahan (1)						Rp 27.283.750
2	Upah Tukang					
	1. Tukang (2 orang)	OH	20,00	Rp	150.000	Rp 3.000.000
	3. Pekerja (2 orang)	OH	45,00	Rp	110.000	Rp 4.950.000
Sub Total Upah (2)						Rp 7.950.000
3	Alat					
	1. Gerobak / Artco	Buah	4,00	Rp	600.000	Rp 2.400.000
	2. Sewa Molen	Jam	19,50	Rp	367.500	Rp 7.166.250
	4. Timba Cor	buah	4,00	Rp	7.500	Rp 30.000
	5. Sekop	buah	2,00	Rp	100.000	Rp 200.000
	6. Cangkul + Gagang	buah	2,00	Rp	120.000	Rp 240.000
	7. Drum Plastik	Buah	1,00	Rp	250.000	Rp 250.000
	8. Gergaji gorok	nuah	3,00	Rp	141.000	Rp 423.000
Sub Total Sewa Alat (3)						Rp 10.709.250
Jumlah Total biaya (1 + 2 + 3)						Rp 45.943.000
Pembulatan						Rp 45.943.000
Menyetujui Lurah Sungai Keledang		Pendamping		Pokmas Keledang Makmur Ketua		
RAHMADI NIP.19820831 200502 1 004		 NOOR QALBI		 MUCHLIS		
						

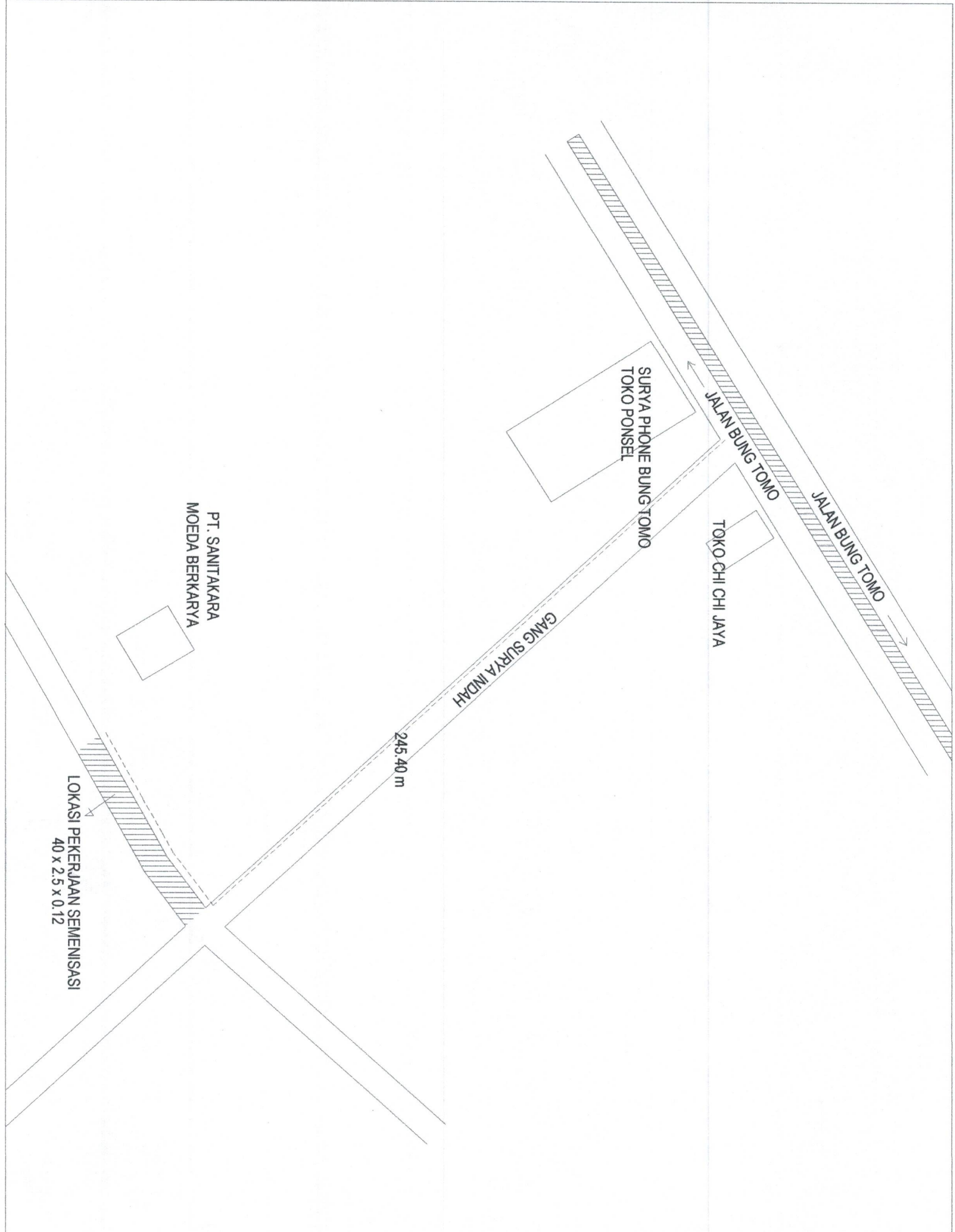

POKMAS KELEDANG MAKMUR

KEGIATAN

PEMBERDAYAAN KELURAHAN

SUB KEGIATAN

PEMBANGUNAN SARANA DAN PRASARANA KELURAHAN

PEKERJAAN

SEMENISASI
40 x 2.5 x 0.25

LOKASI

JL. BUNG TOMO GG. SURYA INDAH
RT. 23

MENGETAHUI / MENYETUJUI

LURAH SUNGAI KELEDANG

RAHMADI, S.P.
NIP 19820831 200502 1 004

TENAGA PENDAMPING

(Signature)

NOOR QALBI

KETUA POKMAS

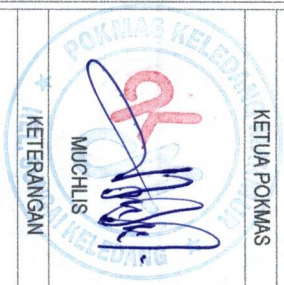

MUCHLIS
KETERANGAN

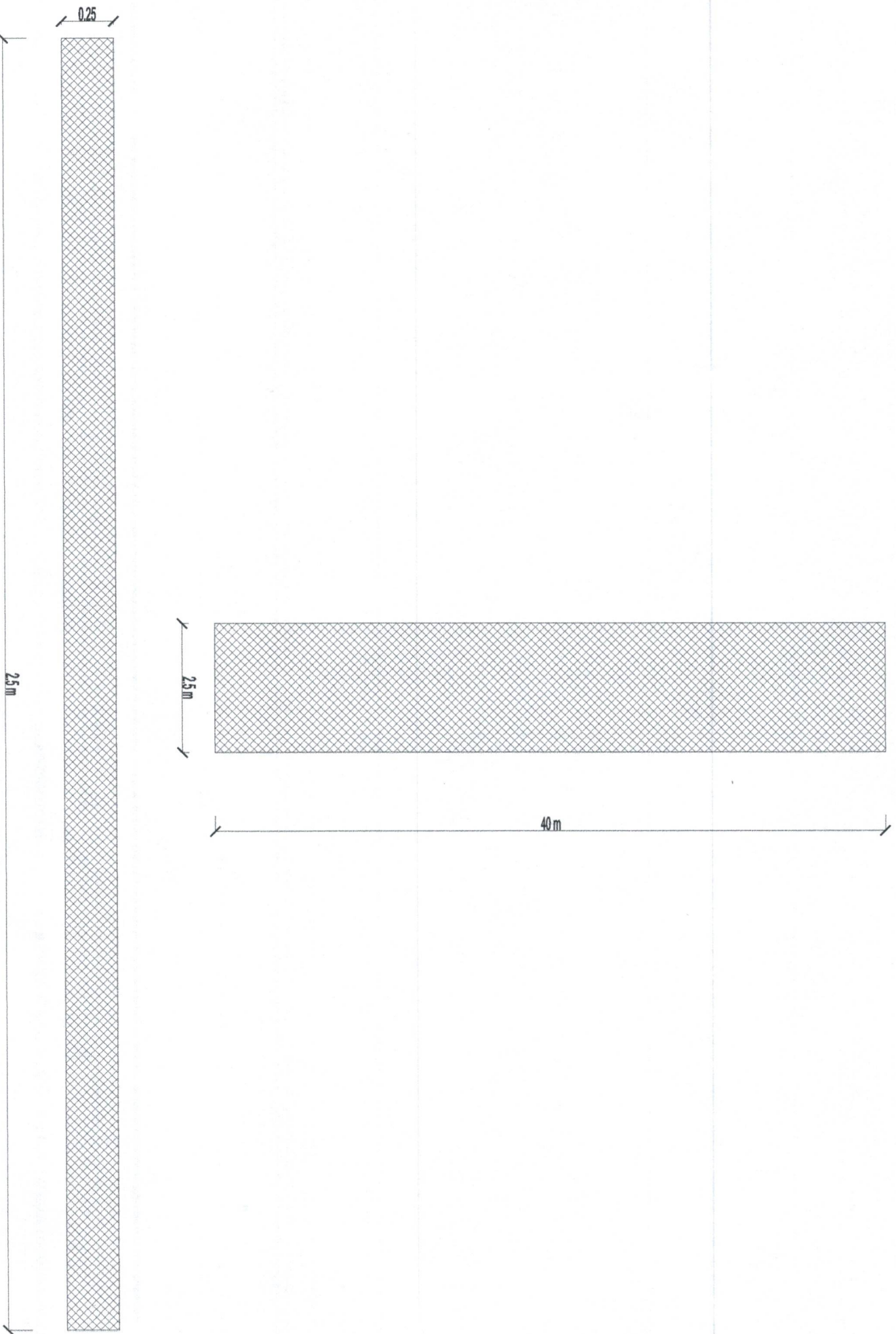

POKMAS KELEDANG MAKMUR

KEGIATAN

PEMBERDAYAAN KELURAHAN

SUB KEGIATAN

PEMBANGUNAN SARANA DAN PRASARANA KELURAHAN

PEKERJAAN

SEMENISASI
40 x 2.5 x 0.25

LOKASI

JL. BUNG TOMO GG. SURYA INDAH
RT. 23

MENGETAHUI / MENYETUJUI
LURAH SUNGAI KELEDANG

RAHMADI, S.P.
NIP. 19820831 200502 1 004
TENAGA PENDAMPING

NOOR QALBI

KETUA POKMAS



**RENCANA ANGGARAN BELANJA
BIDANG INFRASTRUKTUR**

Kota : Samarinda
Kel : Samarinda seberang
Kec : Sungai Keledang

Kegiatan : Posyandu
Volume : 3.5 x 5.5 x 3

Lokasi RT : 24, Jl. Rell Keledang

NO	URAIAN PEKERJAAAN	SAT	VOL	HARGA SATUAN		TOTAL HARGA
1	Upah					
	1. Tukang (2 orang)	OH	45,00		150.000	6.750.000
	2. Pekerja (2 orang)	OH	45,00		110.000	4.950.000
	Total Upah (1)					11.700.000
2	Bahan					
	1. Balok ulin 10/10 x 4 m - 2 m	Batang	25,00	Rp	264.000	Rp 6.600.000
	2. Batu Padas	M3	4,00	Rp	315.700	Rp 1.262.800
	3. Pasir Mahakam	M3	4,00	Rp	198.000	Rp 792.000
	4. Batu Pecah 1 , 2 cm	M3	1,00	Rp	367.500	Rp 367.500
	5. Semen 50 kg	Zak	25,00	Rp	65.000	Rp 1.625.000
	6. Besi SNI 10 mm	Batang	10,00	Rp	68.300	Rp 683.000
	7. Besi SNI 6 mm	Batang	8,00	Rp	28.000	Rp 224.000
	8. Kawat Bengrat	Kg	3,00	Rp	27.500	Rp 82.500
	9. Plywod 9 mm	Lembar	5,00	Rp	126.500	Rp 632.500
	10. Balok 5/7	M3	0,50	Rp	3.500.000	Rp 1.750.000
	11. Papan bauplank	lemabr	20,00		33.500	670.000
	12. Kayu Perancah	M3	1,00		2.200.000	2.200.000
	13. Paku 1 , 2 , 3	Kg	4,83	Rp	26.000	Rp 125.600
	Sub Total Bahan (2)					Rp 17.014.900
3	DINDING KUSEN PINTU					
	1. Besi SNI 10 mm	Batang	12,00	Rp	68.300	Rp 819.600
	2. Besi SNI 6 mm	Batang	12,00	Rp	28.000	Rp 336.000
	3. Bata merah	Buah	3.000,00	Rp	950	Rp 2.850.000
	4. Semen 50 Kg	Zak	30,00	Rp	65.000	Rp 1.950.000
	5. Pasir Mahakam	M3	12,00	Rp	198.000	Rp 2.376.000
	6. Batu Pecah 1 . 2 cm	M3	1,00	Rp	367.500	Rp 367.500
	7. Kusen pintu jendela	Meter	30,00	Rp	80.000	Rp 2.400.000
	8. Pintu Panel Doble	Buah	2,00	Rp	900.000	Rp 1.800.000
	9. Pintu Wc	Buah	1,00	Rp	700.000	Rp 700.000
	10. Engsel	Set	5,00	Rp	60.000	Rp 300.000
	11. Gerendel 3	Buah	6,00	Rp	37.000	Rp 222.000
	12. Pegangan Pintu WC	Set	1,00	Rp	150.000	Rp 150.000
	13. Kunci Pintu Doble	Set	1,00	Rp	500.000	Rp 500.000
	Sub Total Bahan (2)					Rp 14.771.100
4	ATAP BAJA RINGAN					
	1. Taso Kencana 75/65	Batang	30	Rp	98.000	Rp 2.940.000
	2. Ring 30	Batang	20	Rp	43.000	Rp 860.000
	3. Lisplang Calsiboard	Lbr	10	Rp	40.000	Rp 400.000
	4. Baut Baja Ringan	Kotak	1	Rp	211.000	Rp 211.000
	5. Atap Spandek 6 m	Lbr	8	Rp	270.000	Rp 2.160.000
	Sub Total Bahan (3)					Rp 6.571.000
	Sub Total Biaya (1 + 2 + 3 + 4)					Rp 50.057.000
	Total					Rp 50.057.000

Menyetujui
Lurah Sungai Keledang

RAHMADI
NIP.19820831 200502 1 004

Pendamping

NOOR QALBI

Pokmas Keledang Makmur
Ketua

MUCHLIS

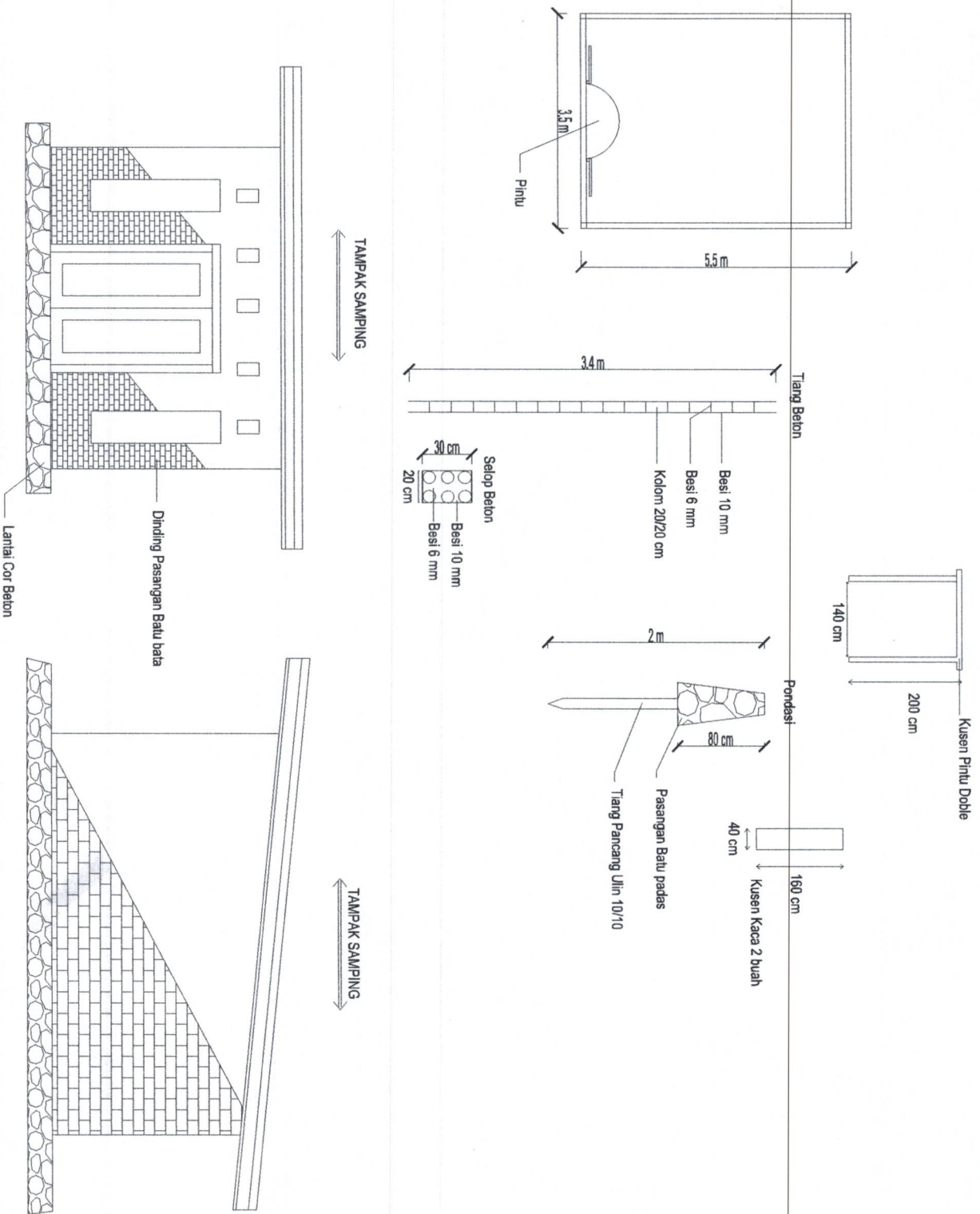

POKMAS KELEDANG MAKKUIR

KEGIATAN

PEMBERDAYAAN KELURAHAN

SUB KEGIATAN

PEMBANGUNAN SARANA DAN PRASARANA KELURAHAN

PEKERJAAN

PEMBANGUNAN POSYANDU
3.5 M x 4.5 M

LOKASI

JL. REEL KELDANG
RT. 24

MENGETAHUI / MENYETUJUI

LURAH SUNGAI KELEDANG

RAHMADI, S.P.
NIP. 19820831 200502 1 004

TEWAGA PENDAMPING

(Signature)

NOOR QALBI

KETUA POKMAS





POKMAS KELEDANG MAKMUR

KEGIATAN

PEMBERDAYAAN KELURAHAN

SUB KEGIATAN

PEMBANGUNAN SARANA DAN PRASARANA KELURAHAN

PEKERJAAN

POSYANDU

3.5 m x 4.5 m

LOKASI

JL. REL KELEDANG
RT. 24

MENGETAHUI / MENYETUJUI
LURAH SUNGAI KELEDANG

RAHMADI, S.P.
NIP 19820831 200502 1 004

TEMAGA PENDAMPING

NOOR QALBI

KETUA POKMAS



KETERANGAN

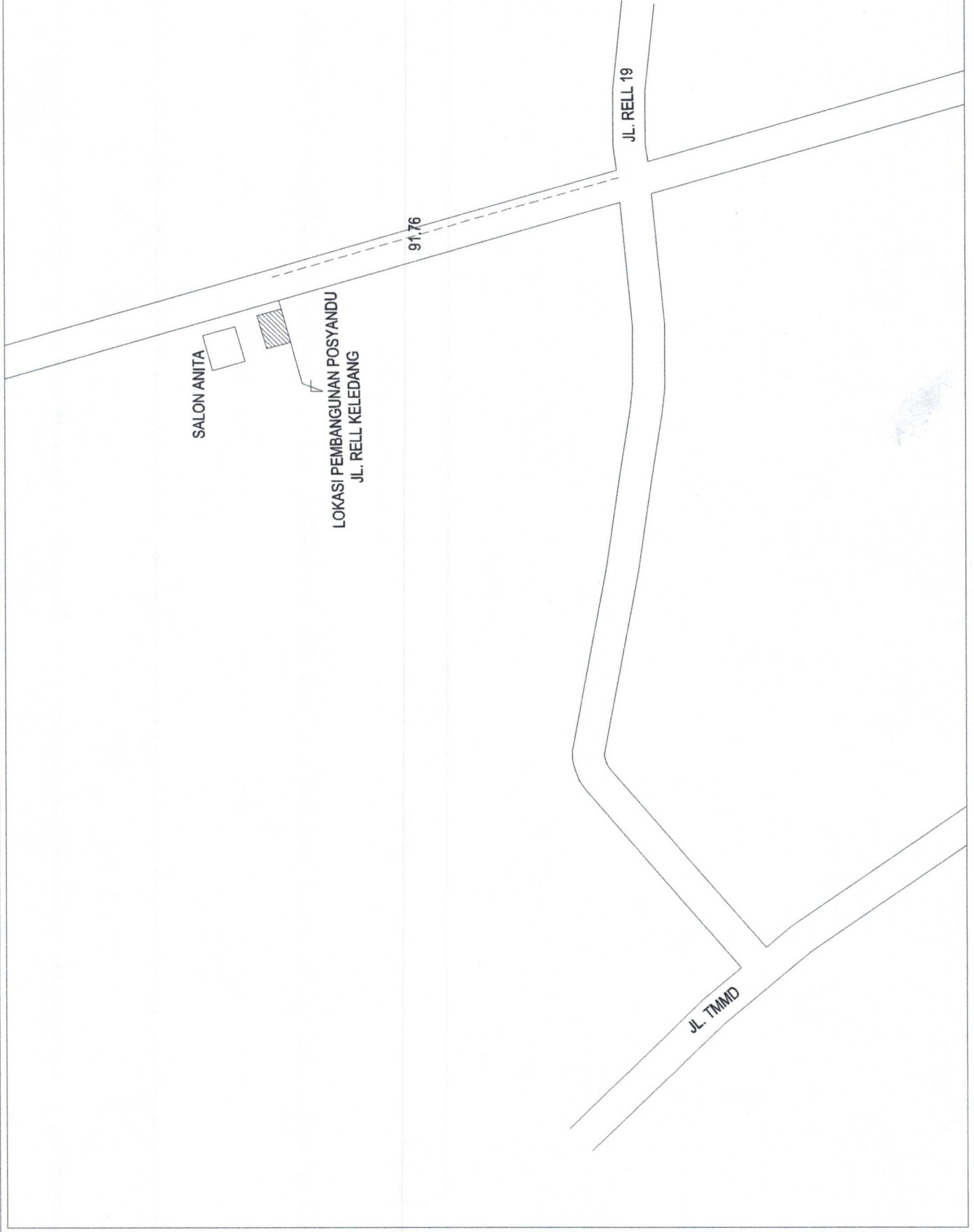

**RENCANA ANGGARAN BELANJA
BIDANG INFRASTRUKTUR**

Kota : Samarinda
Kel : Samarinda seberang
Kec : Sungai Keledang

Kegiatan : Semenisasi
Volume : 60 x 1 x 0.12

7.2 M3

Lokasi RT : 24, Jl. Rell Keledang

NO	URAIAN PEKERJAAAN	SAT	VOL	HARGA SATUAN		TOTAL HARGA
1	Bahan					
	1. Batu Pecah 1-2 cm	M3	4,00	Rp	367.500	Rp 1.470.000
	2. Semen 50 kg	Zak	54,00	Rp	65.000	Rp 3.510.000
	3. Plywod 9 mm	Lembar	5,00	Rp	126.500	Rp 632.500
	4. Paku 2, 3 "	Kg	2,58	Rp	26.000	Rp 67.000
	5. Balok	batang	9,00	Rp	45.000	Rp 405.000
	6. Plastik Cor	M3	50,00	Rp	2.750	Rp 137.500
	7. Pasir	M3	6,00	Rp	198.000	Rp 1.188.000
Sub Total Bahan (1)						Rp 7.410.000
2	Upah Tukang					
	1. Tukang	OH	7,00		150.000	Rp 1.050.000
	2. Pekerja (2 orang)	OH	14,00		110.000	Rp 1.540.000
Sub Total Upah (2)						2.590.000
Jumlah Total biaya (1 + 2)						Rp 10.000.000
Pembulatan						Rp 10.000.000

Menyetujui
Lurah Sungai Keledang

RAHMADI
NIP.19820831 200502 1 004

Pendamping

NOOR QALBI

Pokmas Keledang Makmur
Ketua





POKMAS KELEDANG MAKMUJ

KEGIATAN

PEMBERDAYAAN KELURAHAN

SUB KEGIATAN

PEMBANGUNAN SARANA DAN PRASARANA KELURAHAN

PEKERJAAN

PELEBARAN BADAN JALAN

60 x 1 x 0.12

LOKASI

JL. REL KELEDANG

RT. 24

MENGETAHUI / MENYETUJUI

LURAH SUNGAI KELEDANG

RAHMADI, S.P.

NIP 19820831 200502 1 004

TENAGA PENDAMPING

NOOR QALBI

KETUA POKMAS



MUCHLIS

KETERANGAN

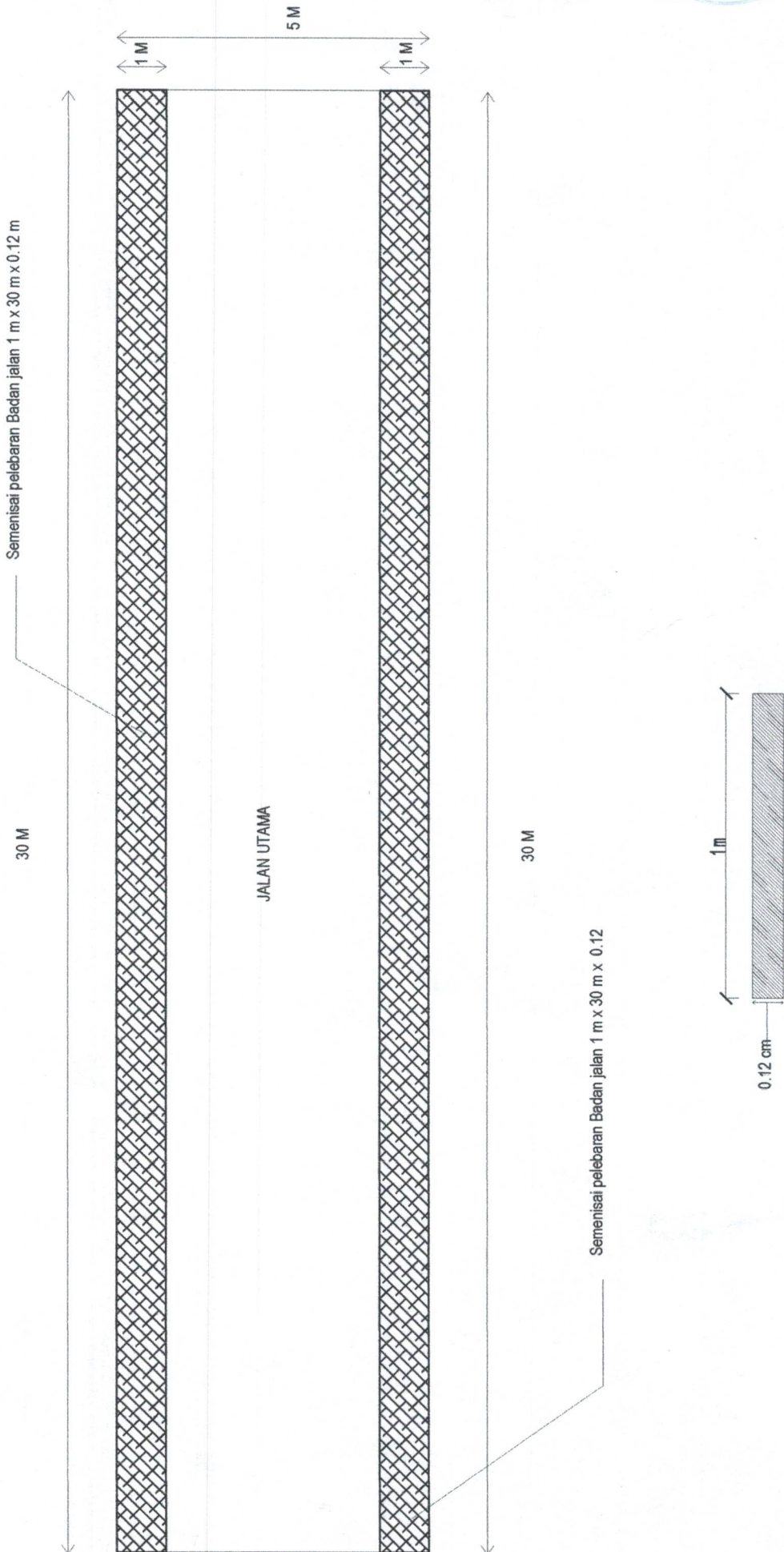

LOKASI PEKERJAAN
Semenisasi RT. 24 (60 x 1 x 0.12)

Gedung Aritengga

89.07 m

Produsen Roti
Bakar & Burger

Jl. Reli 19



POKMAS KELEDANG MAKMUR

KEGIATAN

PEMBERDAYAAN KELURAHAN

SUB KEGIATAN

PEMBANGUNAN SARANA DAN PRASARANA KELURAHAN

PEKERJAAN

PELEBARAN BADAN JALAN
60 x 1 x 0.12

LOKASI

PERUM. KELEDANG MAS
RT. 24

MENGETAHUI / MENYETUJUI

LURAH SUNGAI KELEDANG

RAHMADI, S.P.

NIP. 19820831 200502 1 004

TENAGA PENDAMPING

NOOR QALBI

KETUA POKMAS

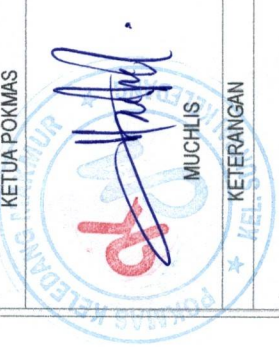

MUCHLIS



KETERANGAN

**RENCANA ANGGARAN BELANJA
BIDANG INFRASTRUKTUR**

Kota : Samarinda
Kec : Samarinda seberang
Kel : Sungai Keledang

Kegiatan : Jembatan Ulin
Volume : 45 x 1.5
Lokasi RT : 01, Jl. Padat Karya

NO	URAIAN	SAT	VOL	HARGA SATUAN	TOTAL HARGA
1	2	3	4	5	6
1	Upah				
	1. Tukang	OH	25.00	Rp 150,000	3,750,000
	3. Pekerja	OH	12.00	Rp 110,000	1,320,000
	Sub Total Upah (1)				5,070,000
2	Bahan				
	1. Papan Ulin panjang 2/16 x 4 m	Lembar	60.00	85,000	5,100,000
	2. Balok ulin 8/8 x 4 m	Batang	100.00	168,000	16,800,000
	3. Balok Ulin 4/8 x 4m	Batang	160.00	84,000	13,440,000
	4. Paku 2 - 3 & 3.5 inc	Kg	9.23	26,000	240,000
	5. Baut 3/8 (10 & 15 cm)	pasang	13.64	33,000	450,000
	Sub Total Bahan (2)				36,030,000
	Jumlah Total biaya (1 + 2 + 3)				41,100,000
	Pembulatan				41,100,000

 <p align="center">Menyetujui Lurah Sungai Keledang</p> <p align="center"><i>[Signature]</i></p> <p align="center">RAHMADI NIP.19820831 200502 1 004</p>	<p align="center">Pendamping</p> <p align="center"><i>[Signature]</i></p> <p align="center">NOOR QALBI</p>	<p align="center">POKMAS KELEDANG JAYA Ketua</p>  <p align="center"><i>[Signature]</i></p> <p align="center">MUSLIM</p>
---------------------------------------------------------------------------------------------------------------------------------------------------------------------------------------------------------------------------------------------------------------------------------	-------------------------------------------------------------------------------------------------------------------	---------------------------------------------------------------------------------------------------------------------------------------------------------------------------------------------------------------------------------------

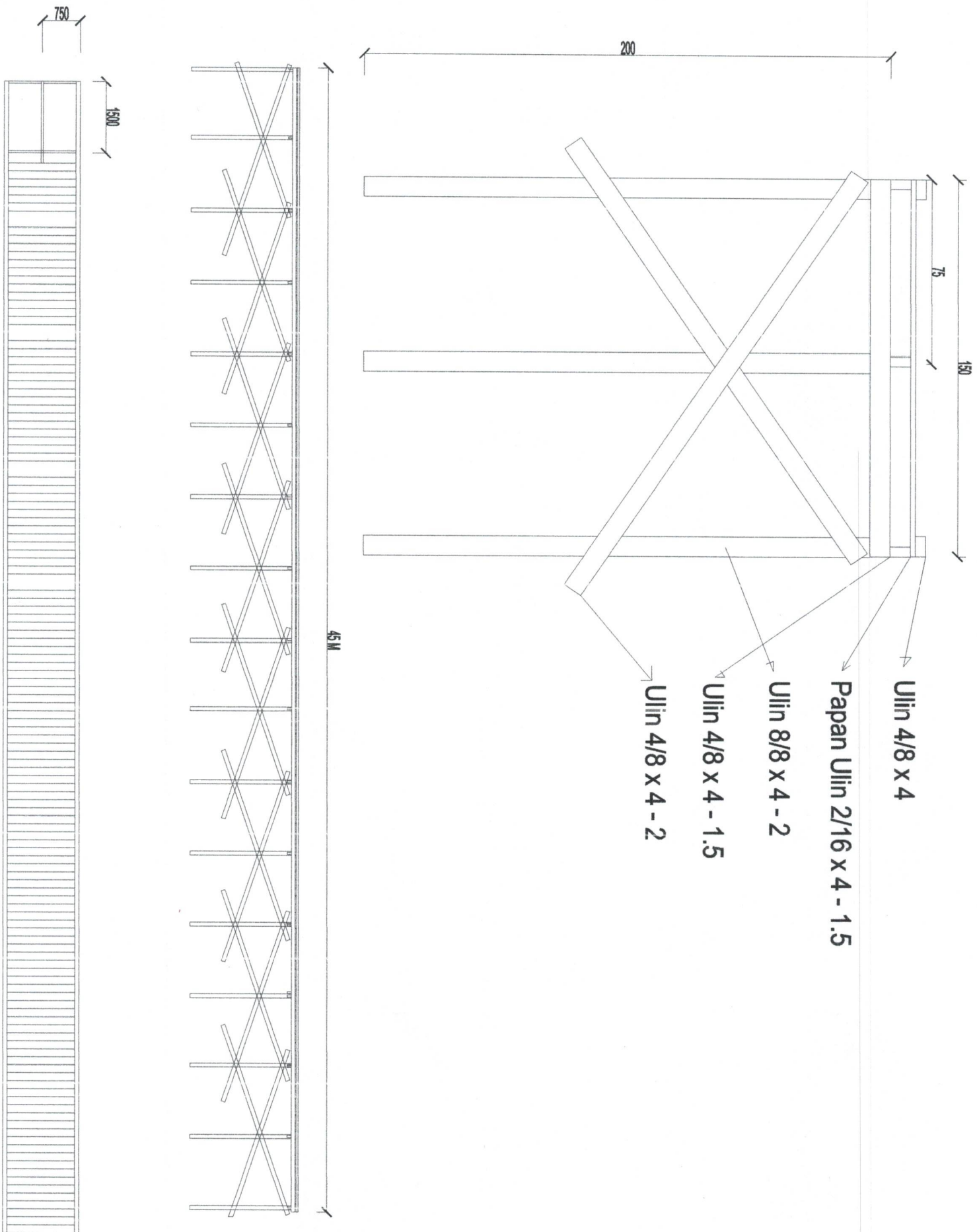

POKMAS KELEDANG JAYA

KEGIATAN

PEMBERDAYAAN KELURAHAN

SUB KEGIATAN

PEMBANGUNAN SARANA DAN PRASARANA KELURAHAN

PEKERJAAN

JEMBATAN ULIN
45 x 1.5 x 2

LOKASI

JL. PADAT KARYA
RT. 01

MENGETAHUI / MENYETUJUI

LURAH SUNGAI KELEDANG

[Signature]

RAHMADI, S.P.

NIP 19820831 200502 1 004

TENAGA PENDAMPING

[Signature]

NOOR QALBI

KETUA POKMAS

[Signature]
MUSLIM

KETERANGAN



Lokasi Pekerjaan Jembatan RT 01

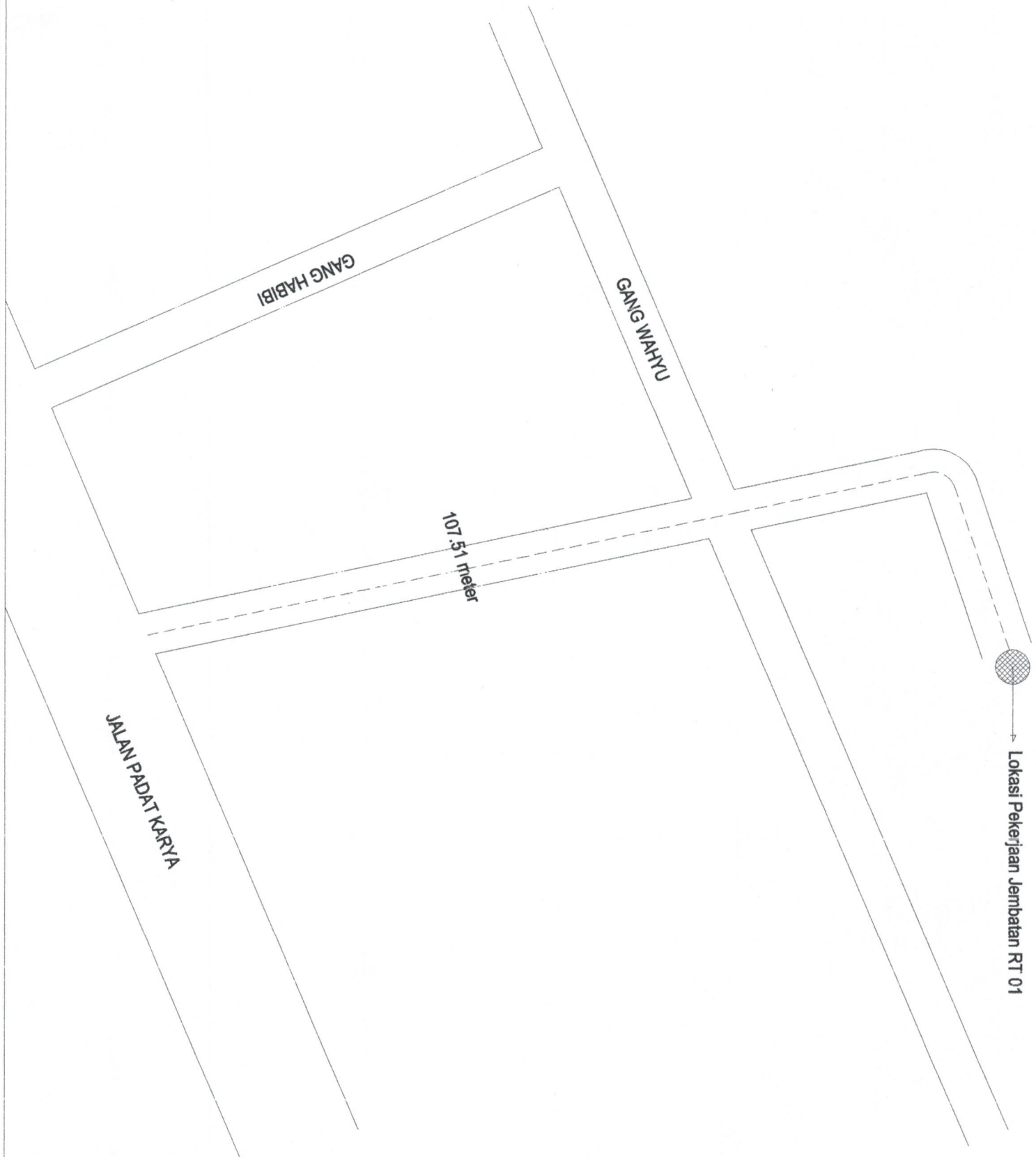

POKMAS KELEDANG JAYA

KEGIATAN

PEMBERDAYAAN KELURAHAN

SUB KEGIATAN

PEMBANGUNAN SARANA DAN PRASARANA KELURAHAN

PEKERJAAN

JEMBATAN UJIN
45 x 1,5 x 2

LOKASI

JL. PADAT KARYA
RT. 01

MENGETAHUI / MENYETUJUI

LURAH SUNGAI KELEDANG

 RAHMADI, S.P.
 NIP. 19820831 200602 1 004

TENAGA PENDAMPING

 NOOR QALBI

KETUA POKMAS

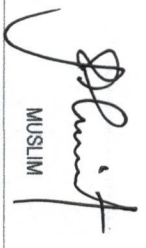
 MUSLIM

KETERANGAN



**RENCANA ANGGARAN BELANJA
BIDANG INFRASTRUKTUR**

Kota : Samarinda
Kec : Samarinda seberang
Kel : Sungai Keledang

Kegiatan : Semenisasi cor Jmbtan
Volume : 60 x 1.3 x 0.12
9.36 M3

Lokasi RT : 02

NO	URAIAN	SAT	VOL	HARGA SATUAN	TOTAL HARGA
1	2	3	4	5	6
1 Upah					
1.	Tukang	HOK	3.00	Rp 150,000	450,000
2.	Pekerja	HOK	16.00	Rp 110,000	1,760,000
Sub Total Upah (1)					2,210,000
2 Bahan					
1.	Semen 50 kg	Zak	76.00	65,000	4,940,000
2.	Plastik Cor	M3	70.00	2,750	192,500
3.	kawat harmonika lobang kecil	Meter	73.00	80,000	5,840,000
4.	Pasir Palu	M3	7.00	575,000	4,025,000
5.	Plywod 9 mm	M3	7.00	126,500	885,500
6.	Paku 2 , 3 inc	kg	3.35	26,000	87,000
7.	Batu Pecah 1 - 2 cm	M3	7.00	367,500	2,572,500
Sub Total Bahan (2)					18,542,500
3 Alat Bantu					
1.	Sewa Molen	Jam	13.00	367,500	4,777,500
2.	Drum Plastik sedang	buah	1.00	250,000	250,000
3.	Timba Cor plastik	Buah	4.00	7,500	30,000
4.	Gerobak / Artco	Buah	1.00	490,000	490,000
Sub Total Sewa Aiat (3)					5,547,500
Jumlah Total biaya (1 + 2 + 3)					26,300,000
Pembulatan					26,300,000

 <p align="center">Menyetujui Lurah Sungai Keledang</p> <p align="center"><i>(Signature)</i> RAHMADI NIP.19820831 200502 1 004</p>	<p align="center">Pendamping</p> <p align="center"><i>(Signature)</i></p> <p align="center">NOOR QALBI</p>	<p align="center">POKMAS KELEDANG JAYA</p> <p align="center">Ketua</p>  <p align="center"><i>(Signature)</i> MUSLIM</p>
-----------------------------------------------------------------------------------------------------------------------------------------------------------------------------------------------------------------------------------------	-------------------------------------------------------------------------------------------------------------------	--------------------------------------------------------------------------------------------------------------------------------------------------------------------------------------------------------------------------------

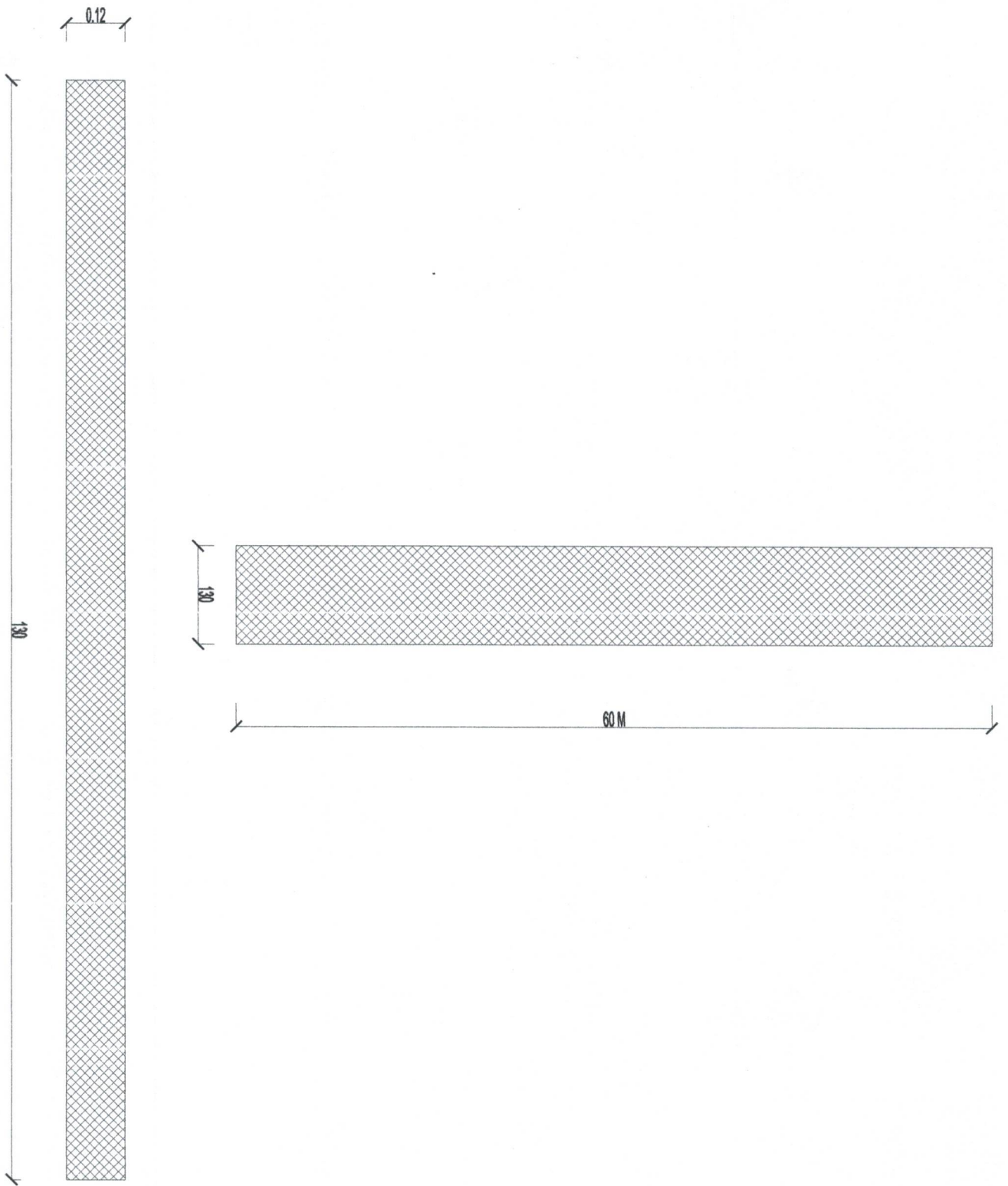

POKMAS KELEDANG JAYA

KEGIATAN

PEMBERDAYAAN KELURAHAN

SUB KEGIATAN

PEMBANGUNAN SARANA DAN PRASARANA KELURAHAN

PEKERJAAN

COR LAPIS JEMBATAN
60 x 1.3 x 0.12

LOKASI

JL. HJ. JAHRAH
RT. 02

MENGETAHUI / MENYETUJUI

LURAH SUNGAI KELEDANG

RAHMADI, S.P.

NIP. 19820831 200502 1 004

TENAGA PENDAMPING

NOOR QALBI

KETUA POKMAS

MUSLIM

KETERANGAN



POKMAS KELEDANG JAWA

KEGIATAN

PEMBERDAYAAN KELURAHAN

SUB KEGIATAN

PEMBANGUNAN SARANA DAN PRASARANA KELURAHAN

PEKERJAAN

COR LAPIS JEMBATAN

60 x 1.3 x 0.12

LOKASI

JL. HJ. JAHRAH
RT. 02

MENGETAHUI / MENSETUJUI

LURAH SUNGAI KELEDANG

R. MAMMADI, S.P.
NIP. 1982031 200502 1 004

TENAGA PENDAMPING



NOOR GALBI

KETUA POKMAS

MUSLIM

KETERANGAN

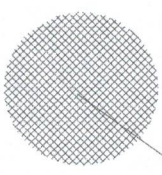
Lokasi Cor Lapis RT 02



JALAN HJ. JAHRAH

GANG IHLAM

**RENCANA ANGGARAN BELANJA
BIDANG INFRASTRUKTUR**



Kota : Samarinda
Kec : Samarinda seberang
Kel : Sungai Keledang

Kegiatan : Gapura
Volume : 0.75 x 5 x 4

15 M3

Lokasi RT : 02, Jl. Hj. Jahrah

NO	URAIAN	SAT	VOL	HARGA SATUAN	TOTAL HARGA
1	2	3	4	5	6
1	Upah				
	1. Tukang	OH	20.00	Rp 150,000	3,000,000
	3. Pekerja	OH	20.00	Rp 110,000	2,200,000
	Sub Total Upah (1)				5,200,000
2	Bahan				
	1. Balok ulin 8/8 x 4 m	Batang	10.00	168,000	1,680,000
	2. Balok Ulin 4/8 x 4m	Batang	16.00	84,000	1,344,000
	3. plywod 9 mm	lembr	4.00	126,500	506,000
	4. Atap Sakura Roof 77 x 80 cm	12	12.00	42,000	504,000
	5. kayu 5/7 x 4 m	Batang	40.00	45,000	1,800,000
	6. Paku - 2 , 3 inc	Kg	8.85	26,000	230,000
	7. Baut 3/8 - 10 cm	pasang	11.02	33,000	363,500
	8. Papan Lisplang	lembr	4.00	185,000	740,000
	Sub Total Bahan (2)				7,167,500
3	Pondasi				
	1. Semen 50 kg	zak	6.00	65,000	390,000
	2. Pasir Palu	M3	1.00	575,000	575,000
	3. Batu Pecah	M3	1.00	367,500	367,500
	Sub Total Bahan (2)				1,332,500
	Jumlah Total biaya (1 + 2 + 3)				13,700,000
	Pembulatan				13,700,000

 <p align="center">Menyetujui Lurah Sungai Keledang</p> <p align="center"><i>(Signature)</i> RAHMADI NIP.19820831 200502 1 004</p>	<p align="center">Pendamping</p> <p align="center"><i>(Signature)</i></p> <p align="center">NOOR QALBI</p>	<p align="center">POKMAS KELEDANG JAYA Ketua</p>  <p align="center"><i>(Signature)</i> MUSLIM</p>
------------------------------------------------------------------------------------------------------------------------------------------------------------------------------------------------------------------------------------------	-------------------------------------------------------------------------------------------------------------------	--------------------------------------------------------------------------------------------------------------------------------------------------------------------------------------------------------------

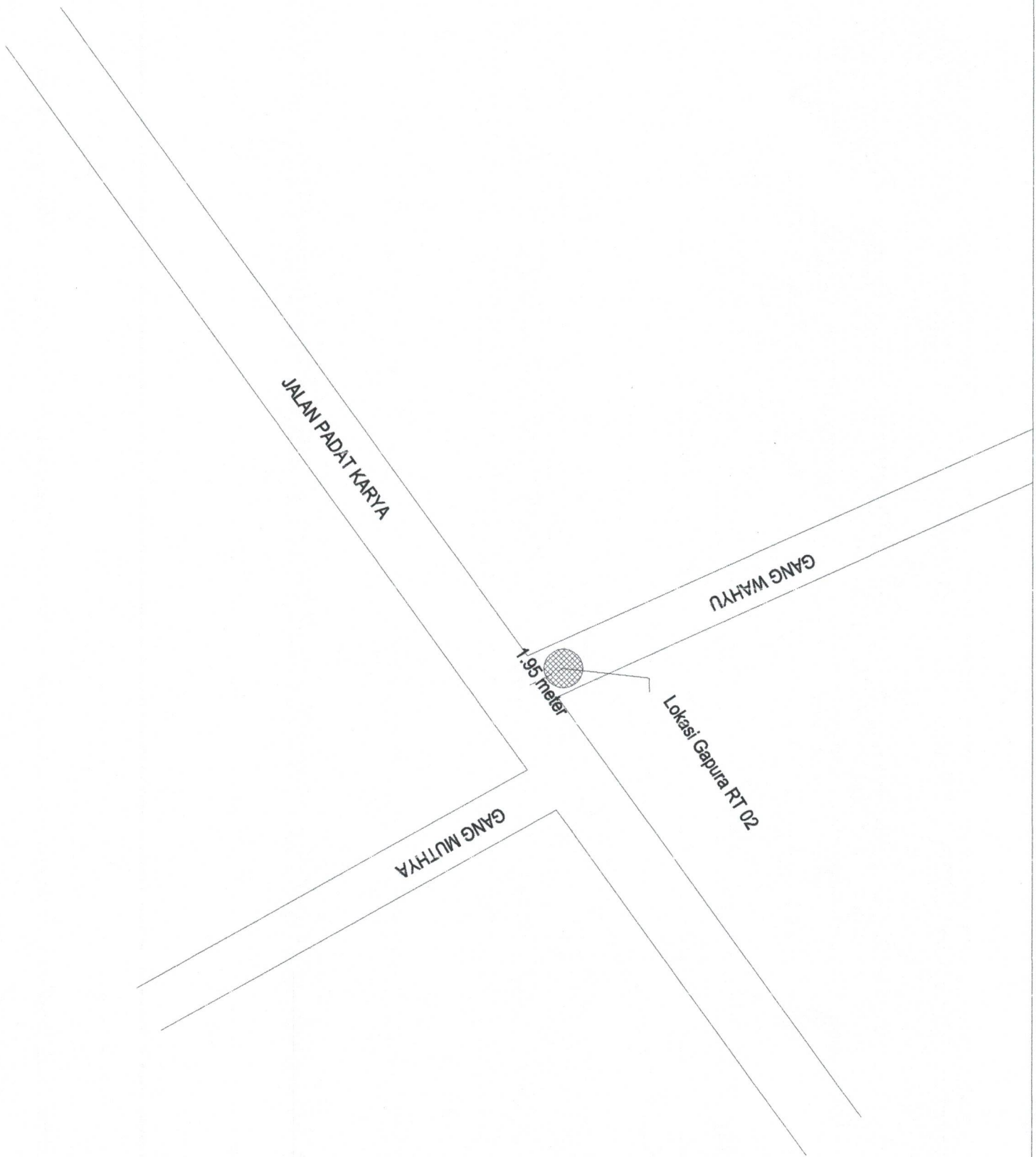

POKMAS KELEDANG JAYA

KEGIATAN

PEMBERDAYAAN KELURAHAN

SUB KEGIATAN

PEMBANGUNAN SARANA DAN PRASARANA KELURAHAN

PEKERJAAN

GAPURA ULIN
0.75 x 5 x 4

LOKASI

JL. HJ. JAHRAH
RT. 02

MENGETAHUI / MENYETUJUI

LURAH SUNGAI KELEDANG

[Signature]
RAMMADI, S.P.
NIP. 19820831 200502 1 004

TENAGA PENDAMPING

[Signature]

NOOR GALBI

KETUA POKMAS

[Signature]
MUSLIM





KETERANGAN

**RENCANA ANGGARAN BELANJA
BIDANG INFRASTRUKTUR**

Kota : Samarinda
Kec : Samarinda seberang
Kel : Sungai Keledang

Kegiatan : Semenisasi
Volume : 50 x 2 x 0.20
20 M3

Lokasi RT : 04, Jl. Dato Iba Gg. Hj Norsehan

NO	URAIAN	SAT	VOL	HARGA SATUAN	TOTAL HARGA
1	2	3	4	5	6
1	Upah				
	1. Tukang	HOK	7.00	Rp 150,000	1,050,000
	2. Pekerja	HOK	35.00	Rp 110,000	3,850,000
	Sub Total Upah (1)				4,900,000
2	Bahan				
	1. Semen 50 kg	Zak	150.00	65,000	9,750,000
	2. Plywod 9 mm	Lembar	15.00	126,500	1,897,500
	3. Balok 5/7 x 4m	Potong	21.00	45,000	945,000
	4. Pasir Palu	M2	10.00	575,000	5,750,000
	5. Paku 2, 3 "	Kg	6.15	26,000	160,000
	6. BBM jenis Bio Solar	Liter	77.67	5,150	400,000
	7. Plastik Cor	M2	120.00	2,750	330,000
	8. BetonMix (cairan Cor)	kg	7.00	45,000	315,000
	9. Batu Pecah 1 - 2 cm	M2	15.00	367,500	5,512,500
	Sub Total Bahan (2)				25,060,000
3	Alat Bantu				
	1. Gerobak / Artco	Buah	2.00	490,000	490,000
	2. Drum Plastik Sedang	Buah	1.00	250,000	250,000
	3. Sewa Alat Molen	Jam	12.00	367,500	4,410,000
	Sub Total Sewa Alat (3)				4,900,000
	Jumlah Total biaya (1 + 2 + 3)				34,860,000
	Pembulatan				34,860,000
 Menyetujui Lurah Sungai Keledang  RAHMADI NIP.19820831 200502 1 004		Pendamping  NOOR QALBI		POKMAS KELEDANG JAYA Ketua   MUSLIM	

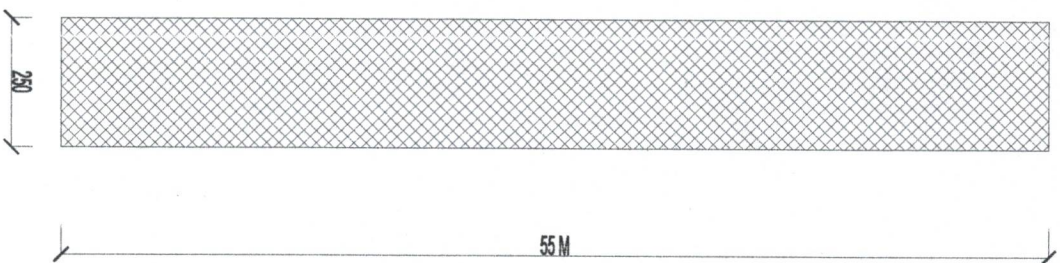
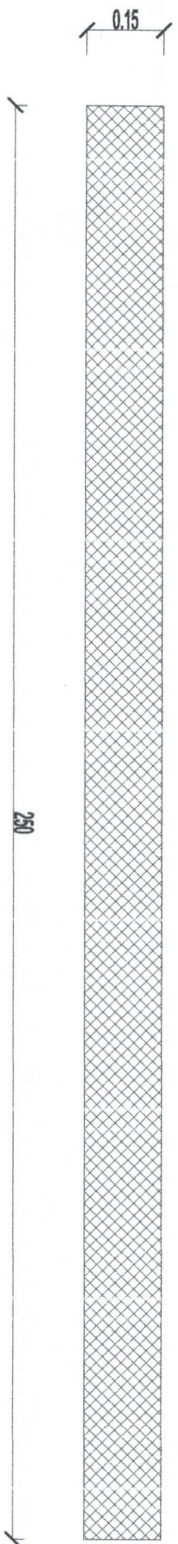

POKMAS KELEDANG JAYA

KEGIATAN

PEMBERDAYAAN KELURAHAN

SUB KEGIATAN

PEMBANGUNAN SARANA DAN PRASARANA KELURAHAN

PEKERJAAN

SEMENISASI
55 x 2 x 0,15

LOKASI

JL. DATO IBA GG. HJ. NOORSEHAN
RT. 04

MENGETAHUI / MENYETUJUI

LURAH SUNGAI KELEDANG

RAHMADI, S.P.

NIP. 19820831 200502 1 004

TENAGA PENDAMPING



NOOR QALBI

KETUA POKMAS

MUSLIM

KETERANGAN

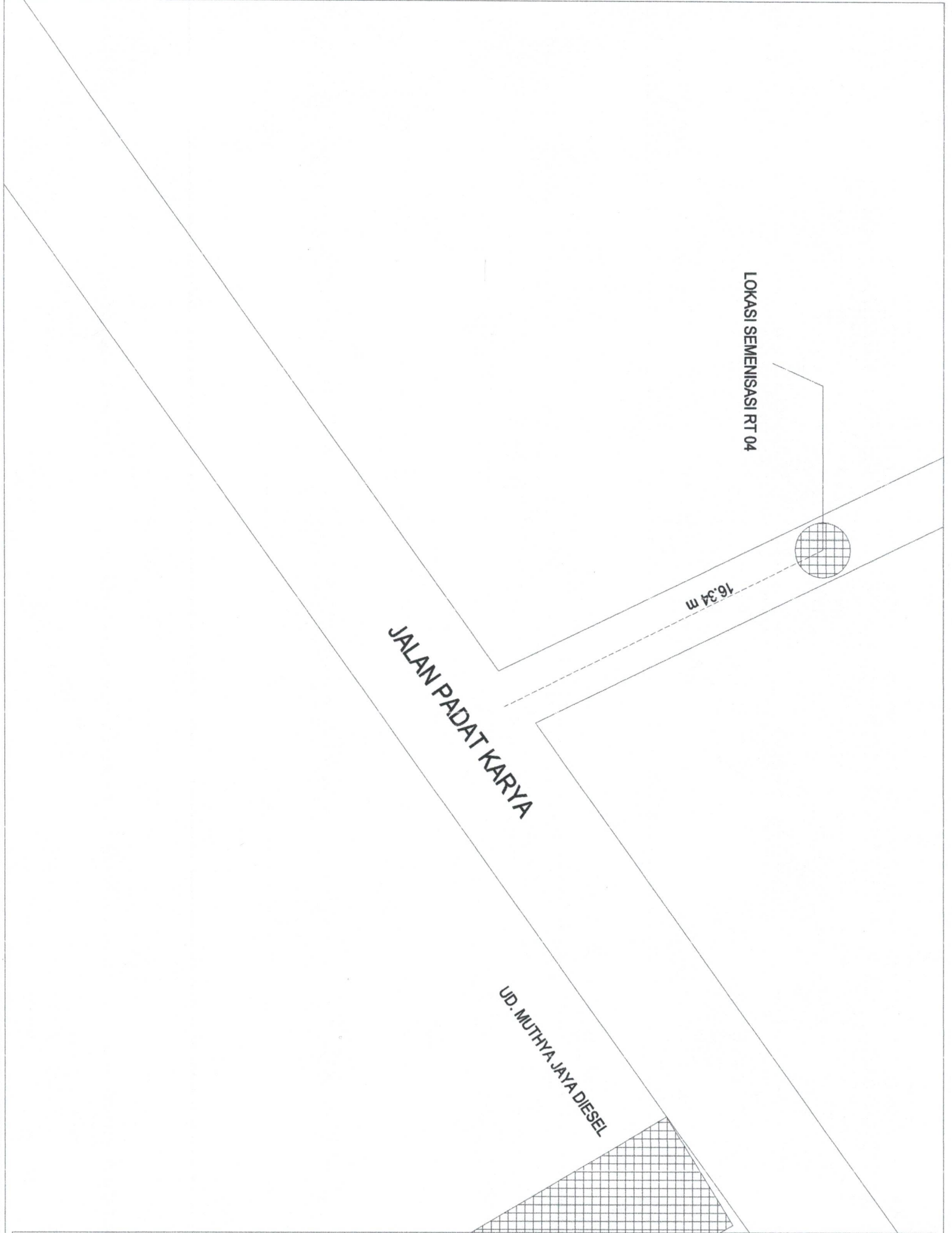

POKMAS KELEDANG JAYA

KEGIATAN

PEMBERDAYAAN KELURAHAN

SUB KEGIATAN

PEMBANGUNAN SARANA DAN PRASARANA KELURAHAN

PEKERJAAN

SEMENISASI
55 x 2 x 0.15

LOKASI

JL. DATO IBA GG. HJ. NOORSEHAN
RT. 04

MENGETAHUI / MENVERIFIKASI

LURAH SUNGAI KELEDANG

RAHMADI, S.P.
NIP. 19820831 200502 1 004

TENAGA PENDAMPING

NOOR QALBI

KETUA POKMAS

MUSLIM

KETERANGAN

**RENCANA ANGGARAN BELANJA
BIDANG INFRASTRUKTUR**

Kota : Samarinda
Kec : Samarinda seberang
Kel : Sungai Keledang

Kegiatan : Semenisasi
Volume : 50 x 2.15 x 0.15
16.125 M3

Lokasi RT : 05, Jl. Dato Iba

NO	URAIAN	SAT	VOL	HARGA SATUAN	TOTAL HARGA
1	2	3	4	5	6
1	Upah				
	1. Tukang	HOK	20.00	Rp 150,000	3,000,000
	2. Pekerja	HOK	20.00	Rp 110,000	2,200,000
	Sub Total Upah (1)				5,200,000
2	Bahan				
	1. Semen 50 kg	zak	120.00	65,000	7,800,000
	2. Plywod 9 mm	Lembar	18.00	126,500	2,277,000
	3. Balok 5/7 x 4m	Batang	31.00	45,000	1,395,000
	4. Batu Pecah 1-2	M3	15.00	367,500	5,512,500
	5. Pasir Palu	M3	13.00	575,000	7,475,000
	6. Plastik Cor	M3	110.00	2,750	302,500
	7. Kawat Harmonika Lobang Besar	M3	99.00	25,000	2,475,000
	8. BetonMix (cairan Beton)	kg	10.00	45,000	450,000
	9. Paku 2, 3 "	Kg	3.73	26,000	97,000
	Sub Total Bahan (2)				27,784,000
3	Alat Bantu				
	1. Drum Plastik Sedang	Buah	1.00	250,000	250,000
	2. Sewa Molen	Jam	10.00	367,500	3,675,000
	3. Gerobak / Artco	Buah	4.00	490,000	1,960,000
	Sub Total Alat (3)				5,885,000
	Jumlah Total biaya (1 + 2 + 3)				38,869,000
	Pembulatan				38,869,000

 Menyetujui
 Lurah Sungai Keledang

RAHMADI
 NIP.19820831 200502 1 004

Pendamping



NOOR QALBI

POKMAS KELEDANG JAYA

Ketua

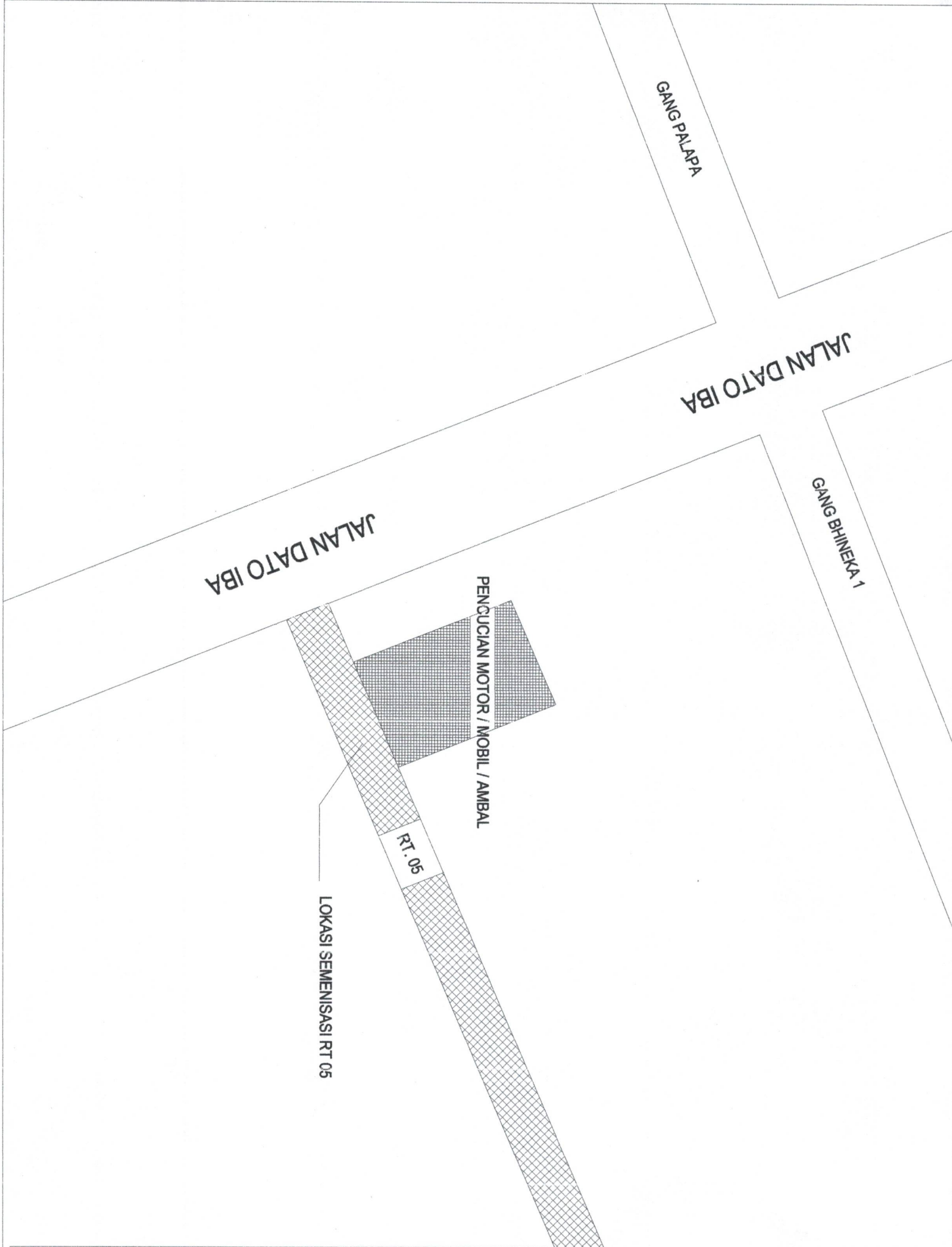

MUSLIM



POKMAS KELEDANG JAYA

KEGIATAN

PEMBERDAYAAN KELURAHAN

SUB KEGIATAN

PEMBANGUNAN SARANA DAN PRASARANA KELURAHAN

PEKERJAAN

GAPURA
3.5 x 3.5

LOKASI

JL. DATO IBA
RT. 05

MENGETAHUI / MENSETUJUI

LURAH SUNGAI KELEDANG

[Signature]
RAHMADI, S.P.

NIP. 19820831 200502 1 004

TENAGA PENDAMPING

[Signature]

NOOR QALBI

KETUA POKMAS

[Signature]
MUSLIM
KETERANGAN

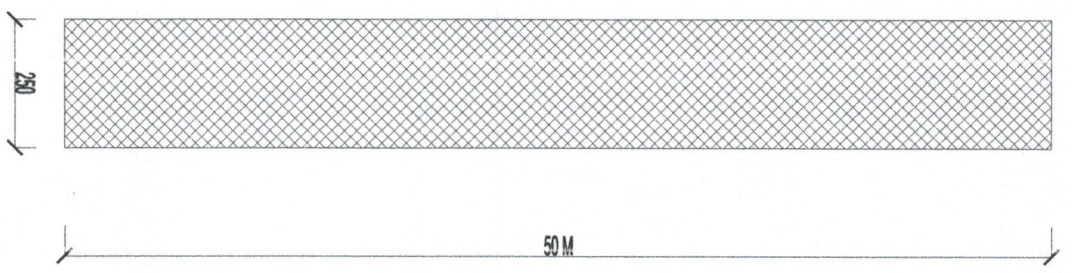
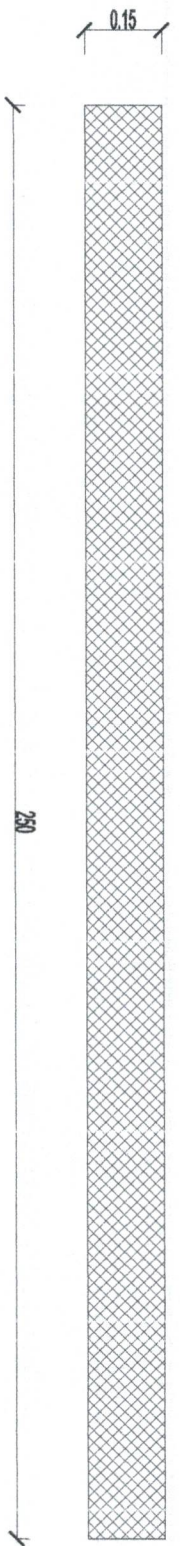

POKMAS KELEDANG JAYA

KEGIATAN

PEMBERDAYAAN KELURAHAN

SUB KEGIATAN

PEMBANGUNAN SARANA DAN PRASARANA KELURAHAN

PEKERJAAN

SEMINISASI COR READYMIX
50 x 2.5 x 0.15

LOKASI

JL. DATO IBA
RT. 05

MENGETAHUI / MENYETUJUI

LURAH SUNGAI KELEDANG

[Signature]
RANMADI, S.P.
NIP. 19820831 200502 1 004

TENAGA PENDAMPING

[Signature]

NOOR QALBI

KETUA POKMAS

[Signature]
MUSLIM
KETERANGAN





**RENCANA ANGGARAN BELANJA
BIDANG INFRASTRUKTUR**

Kota : Samarinda
Kec : Samarinda seberang
Kel : Sungai Keledang

Kegiatan : Gapura
Volume : 3.5 x 3.5

80 M3

Lokasi RT : 05, Jl. Dato Iba

NO	URAIAN	SAT	VOL	HARGA SATUAN	TOTAL HARG
1	2	3	4	5	6
1	Upah				
	1. Tukang	OH	22.00	Rp 150,000	3,300,0
	2. Pekerja	OH	16.00	Rp 110,000	1,760,0
	Sub Total Upah (1)				5,060,0
2	Bahan				
	1. Pipa Stainless 304 tebal 1.5mm - 1 inch	M2	31.00	Rp 60,000	1,860,0
	2. Pipa stainless 304 2" inch x 6 m tebal 1,5 mm	M2	30.00	Rp 70,000	2,100,0
	3. Plat stainless 1 mm x 1220 mm x 2440 mm / sus 304	Lembar	1.00	Rp 1,800,000	1,800,0
	4. Semen 50 kg	Zak	4.00	65,000	260,0
	5. Pasir Palu	m3	1.00	575,000	575,0
	6. Batu Pecah	m3	1.00	367,500	367,5
	7. Paku 2. 3 inc	Kg	5.98	26,000	155,5
	8. Plywod 9mm	Lembar	2.00	126,500	253,0
	9. Kayu Perancah	m3	0.50	2,200,000	1,100,0
	Sub Total Bahan (2)				8,471,0
					13,531,0
	Pembulatan				13,531,0
	 Menyetujui Lurah Sungai Keledang  RAHMADI NIP.19820831 200502 1 004	Pendamping  NOOR QALBI	POKMAS KELEDANG JAYA Ketua   MUSLIM		

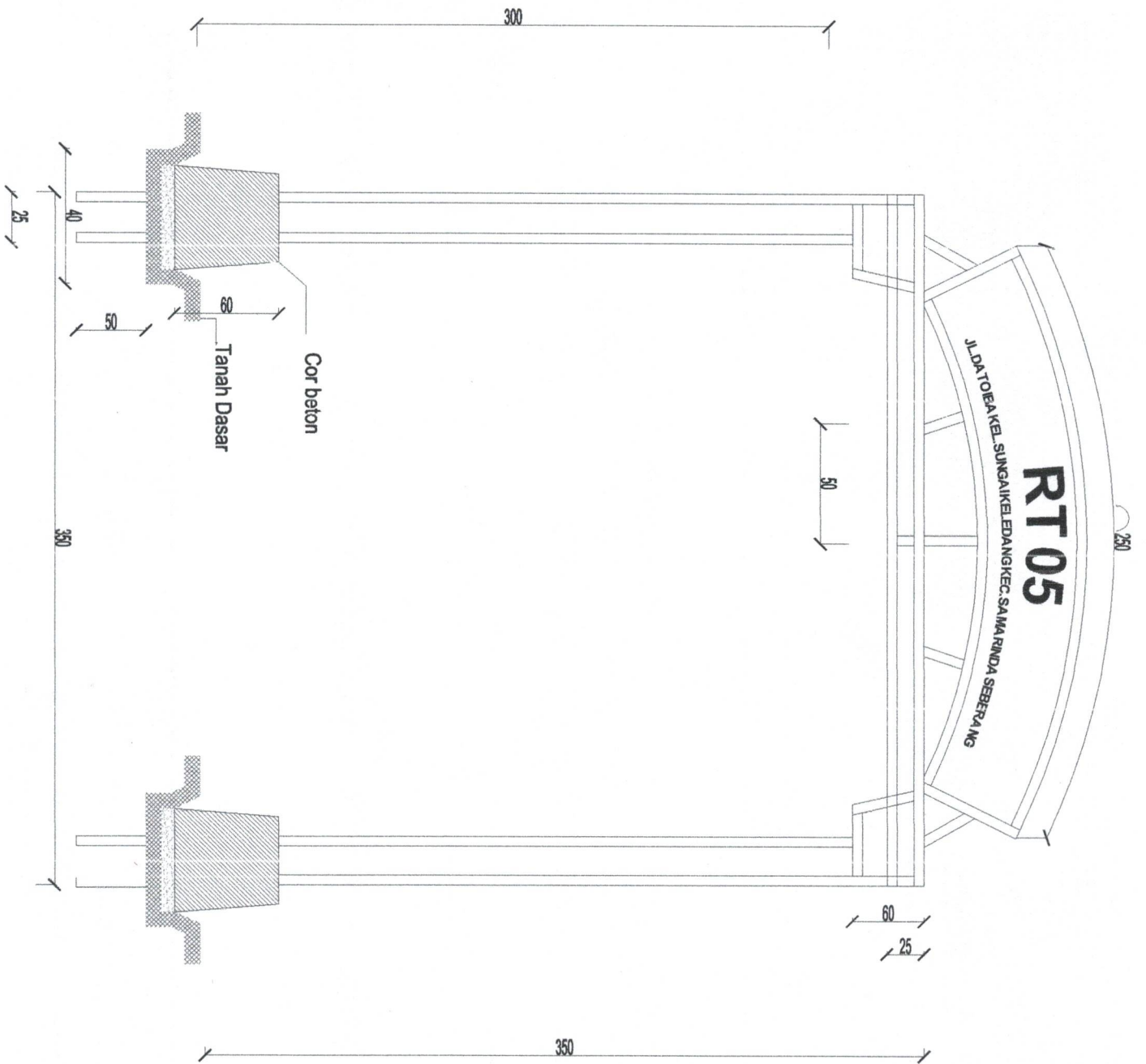

POKMAS KELEDANG JAYA

KEGIATAN

PEMBERDAYAAN KELURAHAN

SUB KEGIATAN

PEMBANGUNAN SARANA DAN PRASARANA KELURAHAN

PEKERJAAN

GAPURA

3.5 x 3.5

LOKASI

JL. DATO IBA
RT. 05

MENGETAHUI / MENYETUJUI

LURAH SUNGAI KELEDANG

RAMADI, S.P.

NIP. 19820831 200502 1 004

TENAGA PENDAMPING

NOOR QALBI

KETUA POKMAS

MUSLIM

KETERANGAN

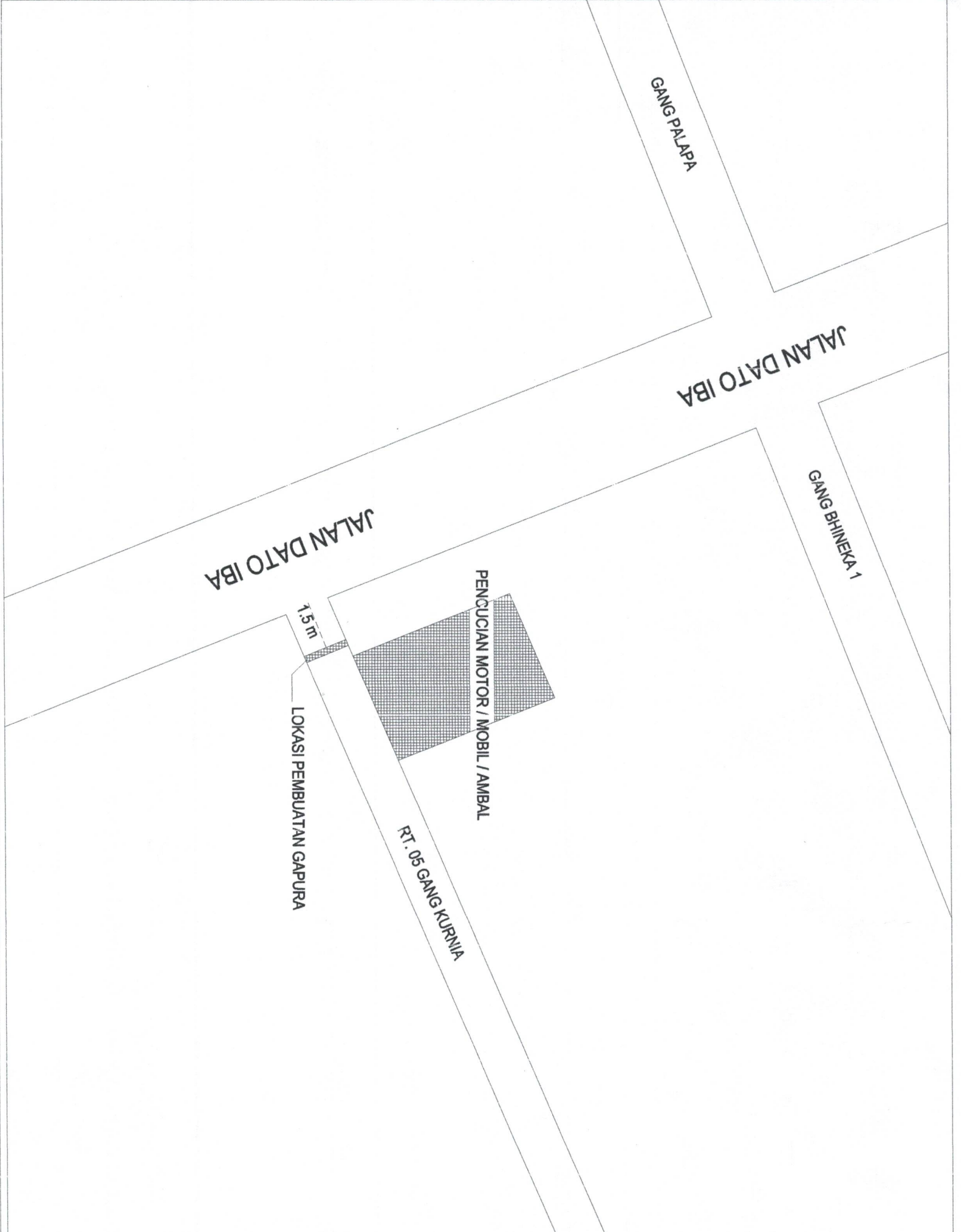

POKMAS KELEDANG JAYA

KEGIATAN

PEMBERDAYAAN KELURAHAN

SUB KEGIATAN

PEMBANGUNAN SARANA DAN PRASARANA KELURAHAN

PEKERJAAN

GAPURA

3.5 x 3.5

LOKASI

JL. DATO IBA
RT. 05

MENGETAHUI / MENSETUJUI

LURAH SUNGAI KELEDANG

[Signature]
RAHMADI, S.P.
NIP. 19820331 200502 1 004

TENAGA PENDAMPING

[Signature]
NOOR QALBI

KETUA POKMAS

[Signature]
MUSLIM
KETERANGAN



**RENCANA ANGGARAN BELANJA
BIDANG INFRASTRUKTUR**

Kota : Samarinda
Kec : Samarinda seberang
Kel : Sungai Keledang

Kegiatan : Semenisasi
Volume : 60 x 3 x 0.12
21.6 M3

Lokasi RT : 06, Jl. Padat Karya Gg. Bineka 1

NO	URAIAN	SAT	VOL	HARGA SATUAN	TOTAL HARGA
1	2	3	4	5	6
1	Upah				
	1. Tukang	HOK	6.00	Rp 150,000	900,000
	2. Pekerja	HOK	36.00	Rp 110,000	3,960,000
	Sub Total Upah (1)				4,860,000
2	Bahan				
	1. Cor Ready Mix	M	23.00	1,430,000	32,890,000
	2. Plywod 9 mm	Lembar	12.00	126,500	1,518,000
	3. Balok 5/7 x 4m	Potong	19.00	45,000	855,000
	4. Paku 2, 3 "	Kg	1.81	26,000	47,000
	5. Plastik Cor	M3	120.00	2,750	330,000
	Sub Total Sewa Alat (2)				35,640,000
	Jumlah Total biaya (1 + 2)				40,500,000
	Pembulatan				40,500,000

 <p align="center">Menyetujui Lurah Sungai Keledang</p> <p align="center"><i>[Signature]</i> RAHMADI NIP.19820831 200502 1 004</p>	<p align="center">Pendamping</p> <p align="center"><i>[Signature]</i></p> <p align="center">NOOR QALBI</p>	<p align="center">POKMAS KELEDANG JAYA Ketua</p>  <p align="center"><i>[Signature]</i> MUSLIM</p>
-----------------------------------------------------------------------------------------------------------------------------------------------------------------------------------------------------------------------------------------	-------------------------------------------------------------------------------------------------------------------	--------------------------------------------------------------------------------------------------------------------------------------------------------------------------------------------------------------

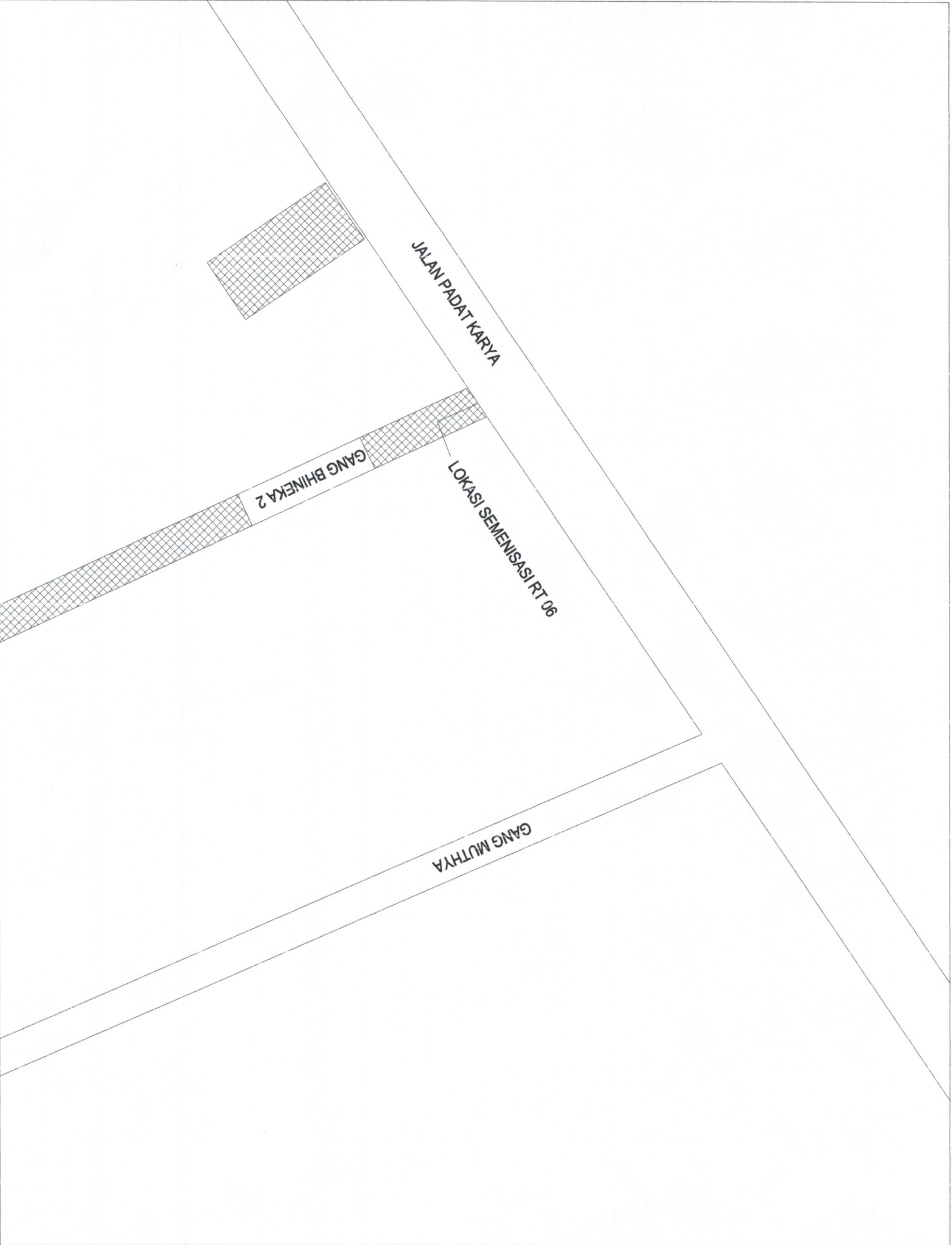

POKMAS KELEDANG JAYA

KEGIATAN

PEMBERDAYAAN KELURAHAN

SUB KEGIATAN

PEMBANGUNAN SARANA DAN PRASARANA KELURAHAN

PEKERJAAN

SEMENISASI
60 x 3 x 0.12

LOKASI

JL. PADAT KARYA GG. BHIWEKA 2
RT. 06

MENGETAHUI / MENYETUJUI

LURAH SUNGAI KELEDANG

(Signature)
RAHMADI, S.P.

NIP 19820831 200502 1 004

TENAGA PENDAMPING

(Signature)

NOOR QALBI

KETUA POKMAS

(Signature)
MUSLIM

KETERANGAN

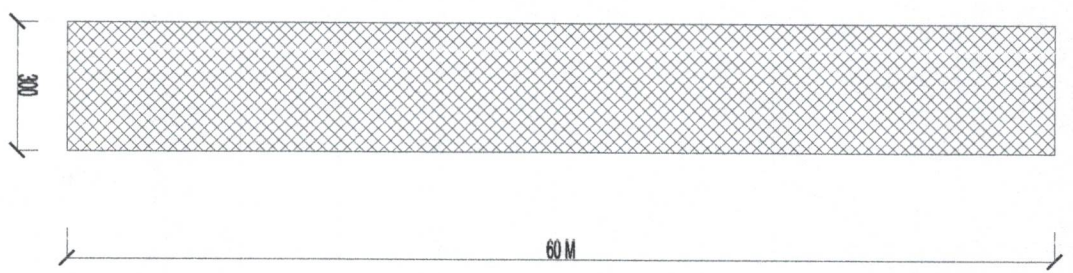
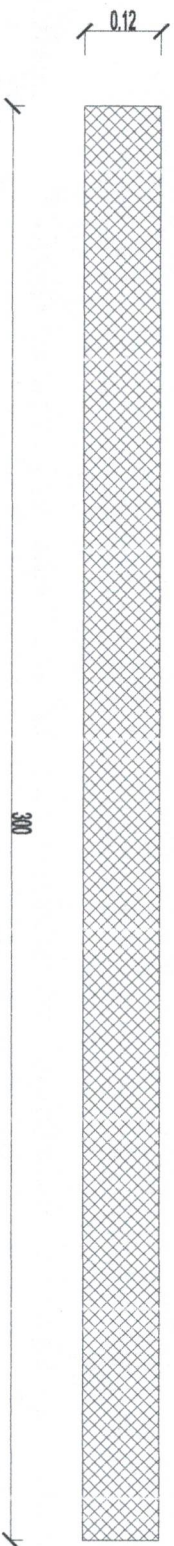

POKMAS KELEDANG JAYA

KEGIATAN

PEMBERDAYAAN KELURAHAN

SUB KEGIATAN

PEMBANGUNAN SARANA DAN PRASARANA KELURAHAN

PEKERJAAN

SEMENISASI

60 x 3 x 0.12

LOKASI

JL. PADAT KARYA GG. BHINEKA 2
RT. 06

MENGETAHUI / MENYETUJUI

LURAH SUNGAI KELEDANG

RAHMADI, S.P.

NIP. 19820831 200502 1 004

TENAGA PENDAMPING

NOOR QALBI

KETUA POKMAS





MUSLIM

KETERANGAN

**RENCANA ANGGARAN BELANJA
BIDANG INFRASTRUKTUR**

Kota : Samarinda
Kec : Samarinda seberang
Kel : Sungai Keledang

Kegiatan : Drainase + Tutup Drainase
Volume : $30 \times (0.6 + 0.6 + 0.5) \times 0.2$
10,2 M3
Lokasi RT : 08, Jl. B. Tomo Gg. H. Syahrhan

NO	URAIAN	SAT	VOL	HARGA SATUAN	TOTAL HARGA
1	2	3	4	5	6
1	Upah				
	1. Tukang	HOK	50.00	Rp 150,000	7,500,000
	3. Pekerja (2 orang)	HOK	50.00	Rp 110,000	5,500,000
	Sub Total Upah (1)				13,000,000
2	Bahan				
	1. Semen 50 kg	Zak	80.00	65,000	5,200,000
	2. Besi Beton Polos Full @ 8 (7,0) x 11,0 m	batang	60.00	32,250	1,935,000
	3. Besi Beton @ 10 x 12.0 m	M3	60.00	68,200	4,092,000
	4. Plywod 9 mm	Lembar	12.00	80,000	960,000
	5. Kawat bendrat	kg	3.00	27,500	82,500
	6. Kayu 5/7 x 4	M2	5.00	45,000	225,000
	7. BBM jenis BIO solar	Liter	80.00	5,150	412,000
	8. Pasir Palu	M3	7.00	557,000	3,899,000
	9. Betonmix (Obat cair cor)	kg	20.00	45,000	900,000
	10. Plastik Cor	m	60.00	2,750	165,000
	11. Kawat Las	set	3.00	1,300,000	3,900,000
	12. Batu Gunung	M3	2.00	750,000	1,500,000
	13. Paku 2,3 Inc	kg	0.96	26,000	25,000
	14. Batu pecah 1-2 cm	M3	9.00	367,500	3,307,500
	Sub Total Bahan (2)				26,603,000
3	Penutup Drainase				
	1. Baja Siku L 30x30x3 - 6m ^{****}	kg	300	20,223	6,066,900
4	Alat Bantu				
	1. Mesin Las	Jam	60.90	55,178	3,360,100
	2. Sewa Molen	Jam	28.00	367,500	10,290,000
	3. Gerobak / Artco	Buah	2.00	490,000	980,000
	Total Sewa Alat (3)				14,630,100
	Jumlah Total biaya (1 + 2 + 3)				60,300,000
	Pembulatan				60,300,000
 Menyetujui Lurah Sungai Keledang  RAHMADI NIP.19820831 200502 1 004		Pendamping  NOOR QALBI		 Ketua  MUSLIM	

TUTUP DRAINASE

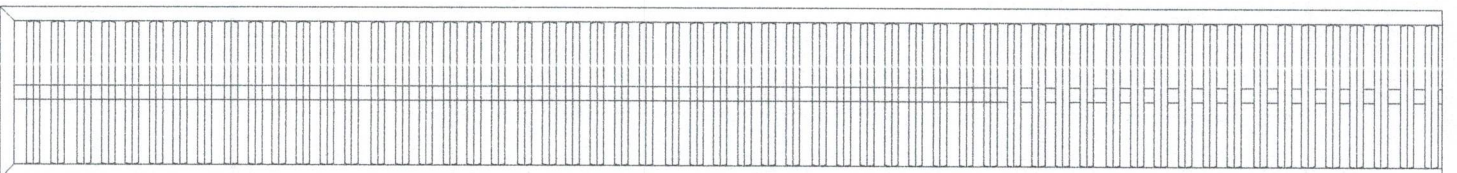
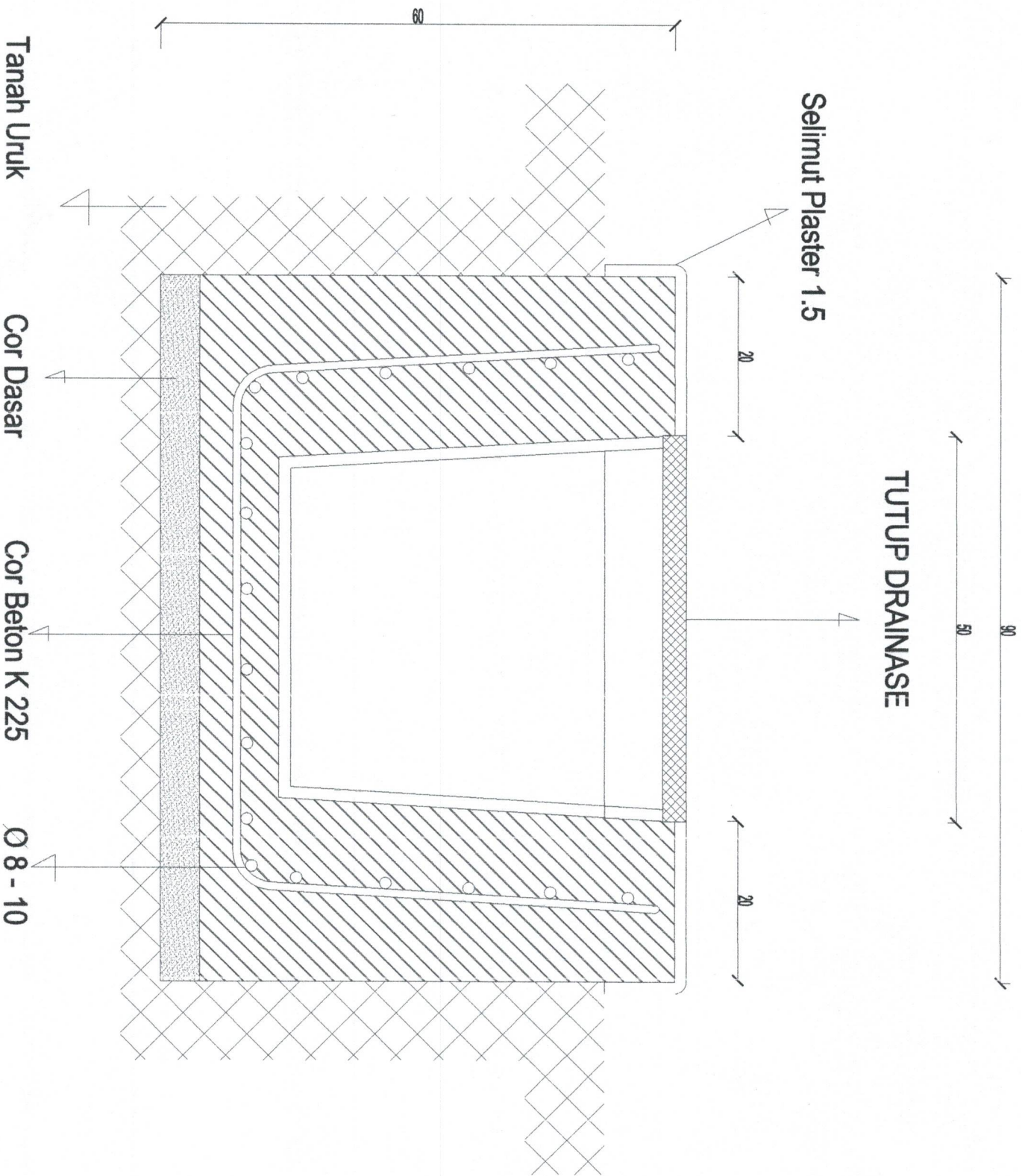

POKMAS KELEDANG JAYA

KEGIATAN

PEMBERDAYAAN KELURAHAN

SUB KEGIATAN

PEMBANGUNAN SARANA DAN PRASARANA KELURAHAN

PEKERJAAN

DRAINASE & TUTUP DRAINASE

0.5 x 0.6 x 30

LOKASI

JL. BUNG TOMO GG. H. SAHRAN RT. 08

MENGETAHUI / MENYETUJUI

LURAH SUNGAI KELEDANG

KAHMADI, S.P.
NIP. 1982031 200502 1 004

TENAGA PENDAMPING

NOOR GALBI

KETUA POKMAS

Muslim
MUSLIM
KETERANGAN

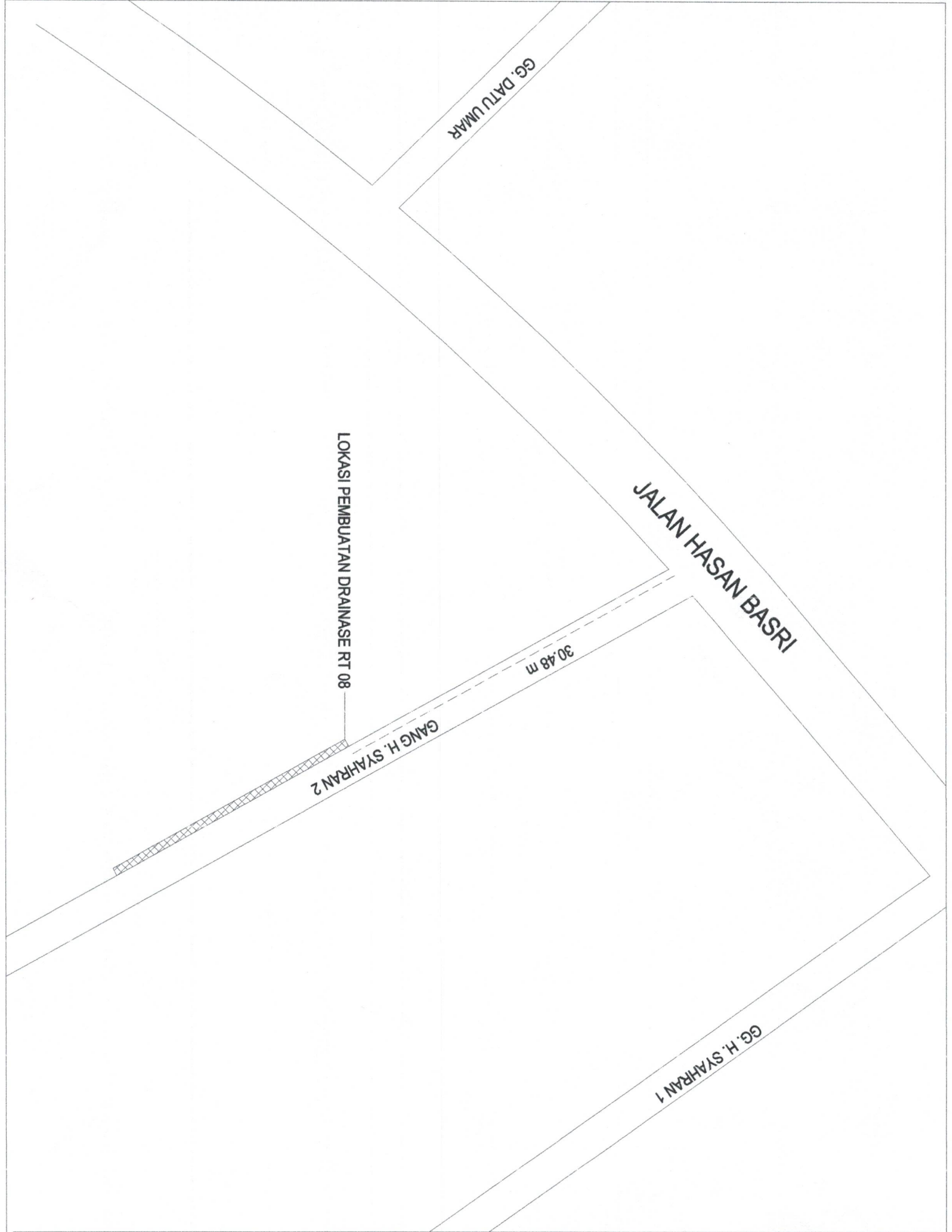

POKMAS KELEDANG JAYA

KEGIATAN

PEMBERDAYAAN KELURAHAN

SUB KEGIATAN

PEMBANGUNAN SARANA DAN PRASARANA KELURAHAN

PEKERJAAN

DRAINASE & TUTUP DRAINASE
0.5 x 0.6 x 30

LOKASI

JL. BUNG TOMO GG. H. SAHRAN
RT. 08

MENGETAHUI / MENYETUJUI

LURAH SUNGAI KELEDANG

(Signature)
RAMMADI, S.P.

NIP. 19820831 200502 1 004

TENAGA PENDAMPING

(Signature)

NOOR QALBI

KETUA POKMAS

(Signature)
MUSLIM
KETERANGAN

**RENCANA ANGGARAN BELANJA
BIDANG INFRASTRUKTUR**



Kota : Samarinda
Kec : Samarinda seberang
Kel : Sungai Keledang

Kegiatan : Jembatan
Volume : 3 x 1 x 1

3 M3

Lokasi RT : 09, Jl. Hasan Basri

NO	URAIAN	SAT	VOL	HARGA SATUAN	TOTAL HARGA
1	2	3	4	5	6
1	Upah				
	1. Tukang	OH	1.00	Rp 150,000	150,000
	3. Pekerja	OH	1.00	Rp 110,000	110,000
	Sub Total Upah (1)				260,000
2	Bahan				
	1. Papan Ulin panjang 2/16 x 4 m	Lembar	5.00	85,000	425,000
	2. Balok ulin 4/8 x 4 m	Batang	2.00	84,000	168,000
	4. Paku 2. 3 inc	Kg	3.08	26,000	80,000
	5. Baut 3/8 - 10cm	pasang	2.03	33,000	67,000
	Sub Total Bahan (2)				740,000
	Jumlah Total biaya (1 + 2)				1,000,000
	Pembulatan				1,000,000

 <p align="center">Menyetujui Lurah Sungai Keledang</p> <p align="center"><i>[Signature]</i> RAHMADI NIP.19820831 200502 1 004</p>	<p align="center">Pendamping</p> <p align="center"><i>[Signature]</i></p> <p align="center">NOOR QALBI</p>	 <p align="center">POKMAS KELEDANG JAYA Ketua</p> <p align="center"><i>[Signature]</i> MUSLIM</p>
------------------------------------------------------------------------------------------------------------------------------------------------------------------------------------------------------------------------------------------	-------------------------------------------------------------------------------------------------------------------	-------------------------------------------------------------------------------------------------------------------------------------------------------------------------------------------------------

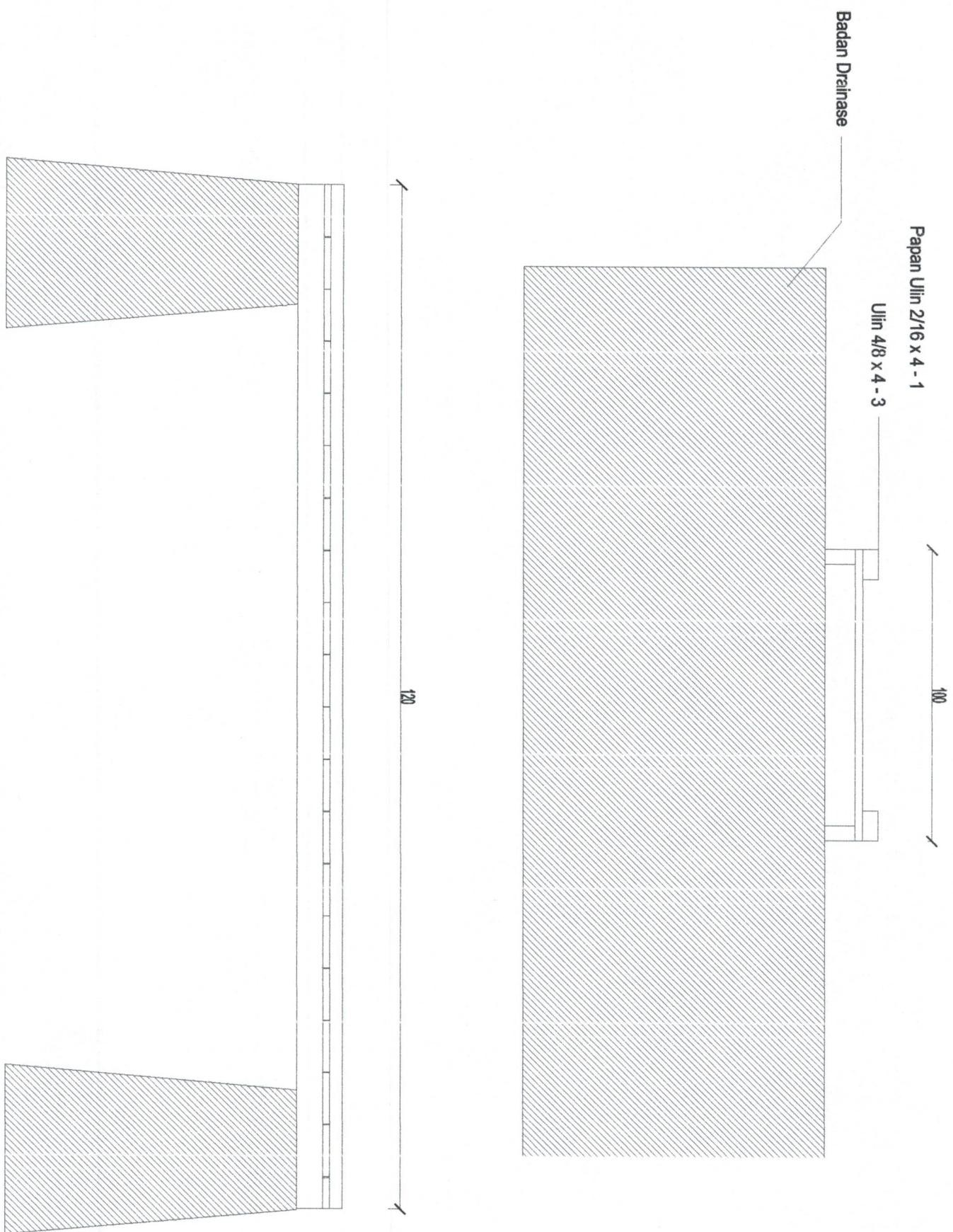

POKMAS KELEDANG JAYA

KEGIATAN

PEMBERDAYAAN KELURAHAN

SUB KEGIATAN

PEMBANGUNAN SARANA DAN PRASARANA KELURAHAN

PEKERJAAN

JEMBATAN KAYU
1 x 12

LOKASI

JL. HASAN BASRI
RT. 09

MENGETAHUI / MENYETUJUI

LURAH SUNGAI KELEDANG

[Signature]
RAHMADI, S.P.

NIP. 19820831 200502 1 004

TENAGA PENDAMPING

[Signature]

NOOR QALBI

KETUA POKMAS

[Signature]

MUSLIM

KETERANGAN

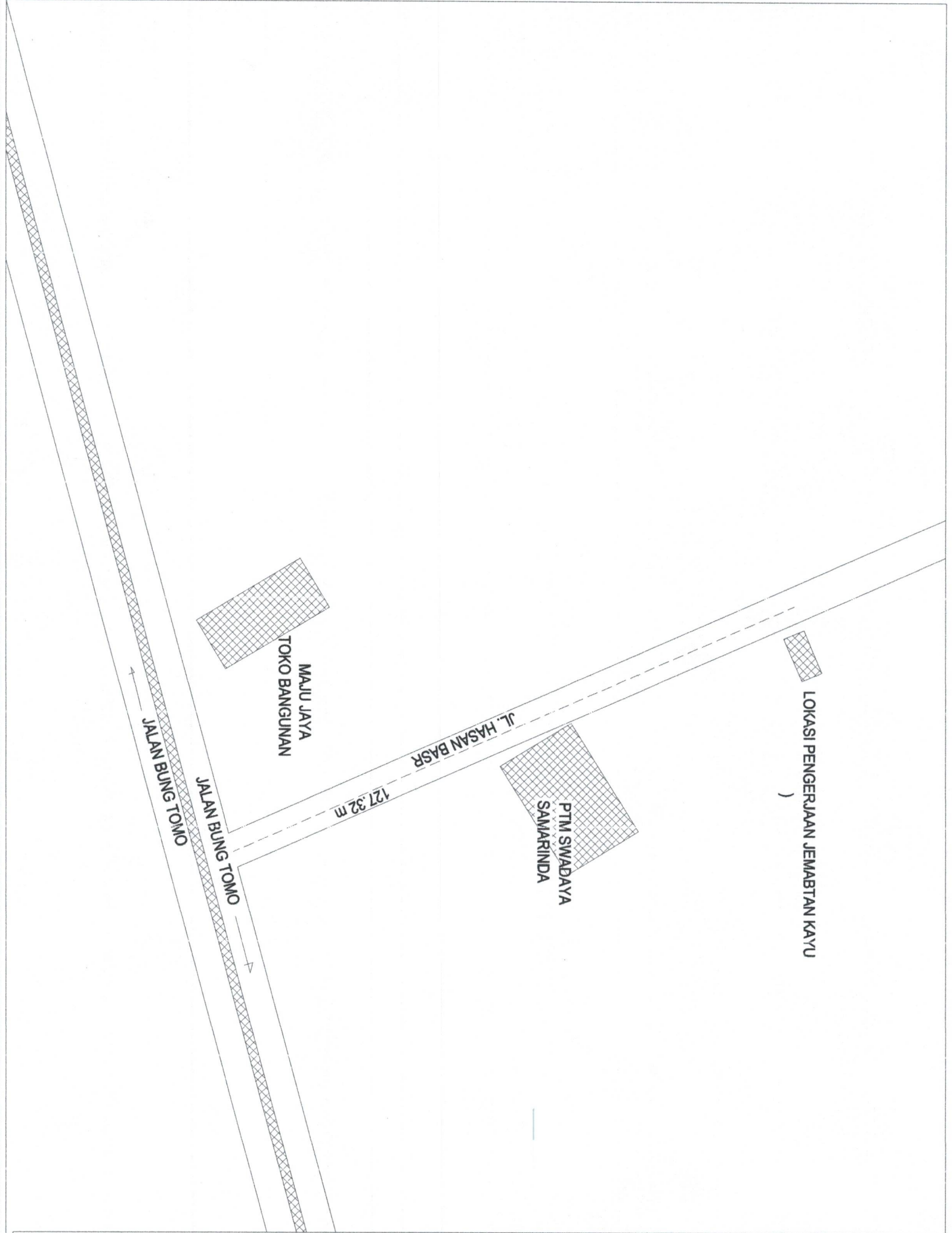

POKMAS KELEDANG JAYA

KEGIATAN

PEMBERDAYAAN KELURAHAN

SUB KEGIATAN

PEMBANGUNAN SARANA DAN PRASARANA KELURAHAN

PEKERJAAN

JEMBATAN KAYU
1 x 12

LOKASI

JL. HASAN BASRI
RT. 09

MENGETAHUI / MENYETUJUI

LURAH SUNGAI KELEDANG

[Signature]
RAHMADI, S.P.

NIP. 19820831 200502 1 004

TENAGA PENDAMPING

[Signature]
NOOR QALBI

KETUA POKMAS

[Signature]
MUSLIM

KETERANGAN





**RENCANA ANGGARAN BELANJA
BIDANG INFRASTRUKTUR**

Kota : Samarinda
Kel : Samarinda seberang
Kec : Sungai Keledang

Kegiatan : Posyandu Lemon (tahap 2)
Volume : 3 x 5 x 6

90 M3

Lokasi RT: 09, Jln. H. Hasan Basri

NO	URAIAN PEKERJAAAN	SAT	VOL	HARGA SATUAN		TOTAL HARGA
1	Upah					
	1. Tukang (2 orang)	OH	60,00		150.000	9.000.000
	2. Pekerja (2 orang)	OH	60,00		110.000	6.600.000
	Total Upah (1)					15.600.000
2	Bahan					
	1. Pasir Mahakam	M3	30,00	Rp	198.000	Rp 5.940.000
	2. Semen 50 kg	Zak	107,00	Rp	65.000	Rp 6.955.000
	3. Bata merah	Buah	7.875,00	Rp	950	Rp 7.481.250
	4. Kawat Bengrat	Kg	4,00	Rp	27.500	Rp 110.000
	4. Plywod 9 mm	Lembar	8,00	Rp	126.500	Rp 1.012.000
	5. Kayu Perancah	M3	1,50		2.200.000	3.300.000
	6. Paku 1 , 2 , 3	Kg	6,42	Rp	26.000	Rp 167.000
	7. Besi Beton Polos Full @ 8 (8,0) x 12,0 m	Batang	8,00	Rp	35.700	Rp 285.600
	8. Besi Beton Polos Full @ 6 (5,0) x 11,0 m	Batang	8,00	Rp	18.375	Rp 147.000
	9. Keramik 30 x 30 cm (Motif)	Kotak	35,00	Rp	85.000	Rp 2.975.000
	10. Mowilex 5 ltr	Kaleng	4,00	Rp	250.000	Rp 1.000.000
	11. Kuas Rol	Buah	3,00	Rp	35.000	Rp 105.000
	12. Batu Pecah 1 - 2 cm	M3	8,00	Rp	367.500	Rp 2.940.000
	13. Kusen pintu jendela	Meter	30,00	Rp	80.000	Rp 2.400.000
	14. Pintu Panel Doble	Buah	2,00	Rp	900.000	Rp 1.800.000
	15. Engsel	Set	5,00	Rp	60.000	Rp 300.000
	16. Gerendel 3	Buah	6,00	Rp	37.000	Rp 222.000
	17. Pintu Wc	Buah	1,00		700.000	700.000
	18. Closed Duduk	Buah	1,00		250.000	250.000
	19. Kunci Pintu Doble	Set	1,00	Rp	500.000	Rp 500.000
	Sub Total Bahan (2)					Rp 38.589.850
3	ATAP BAJA RINGAN					
	1. Taso Kencana 75/65	Batang	8,00	Rp	98.000	Rp 784.000
	2. Ring 30	Batang	8,00	Rp	43.000	Rp 344.000
	3. Lisplang Calsiboard	Lbr	10,00	Rp	40.000	Rp 400.000
	4. Baut Baja Ringan	Kotak	2,00	Rp	211.000	Rp 422.000
	5. BJLS 0.20 mm x 1,8 m x 80 cm	Lbr	7,00	Rp	51.450	Rp 360.150
	Sub Total Atap (3)					Rp 2.310.150
	Sub Total Biaya (1 + 2 + 3)					Rp 56.500.000
	Pembulatan					Rp 56.500.000
	 Menyetujui Lurah Sungai Keledang RAHMADI, SP NIP. 19820831 200502 1 004		Pendamping  NOOR QALBI		Pokmas Keledang Jaya Ketua   MUSLIM	

RUANG ATAS

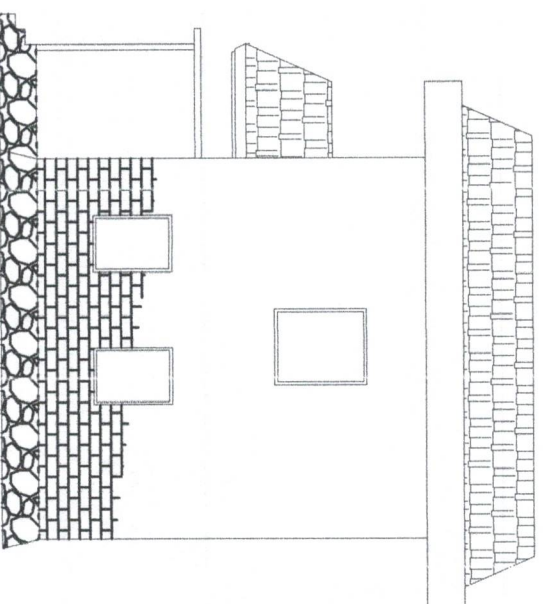
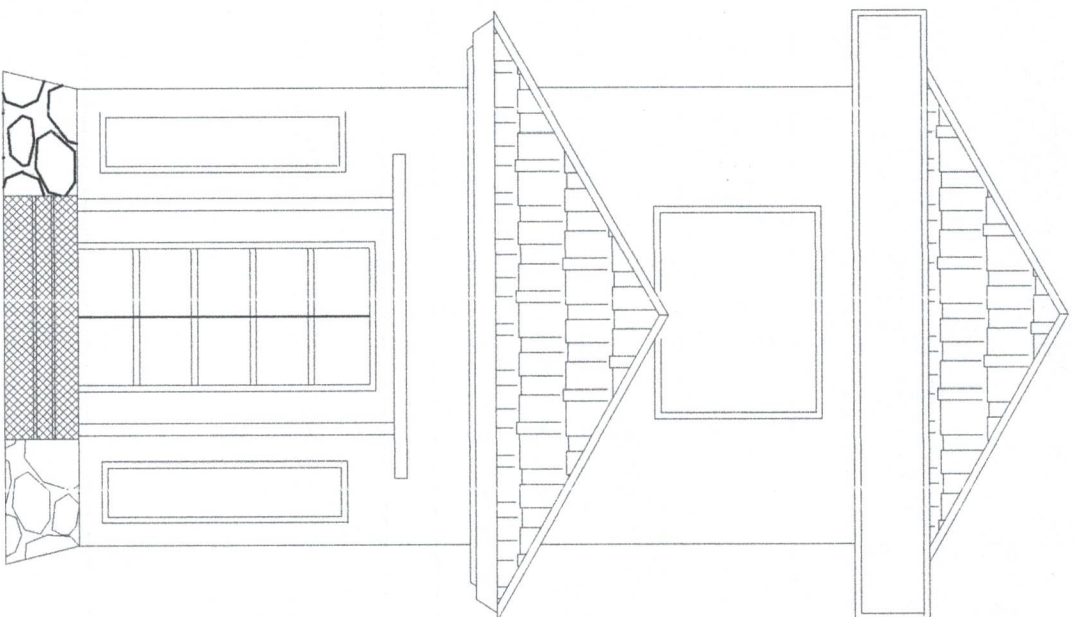
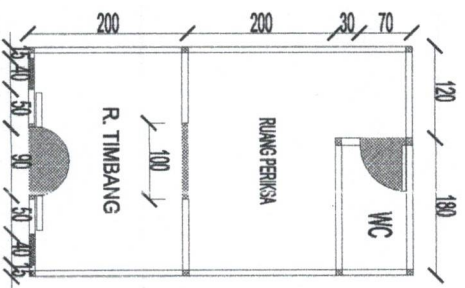
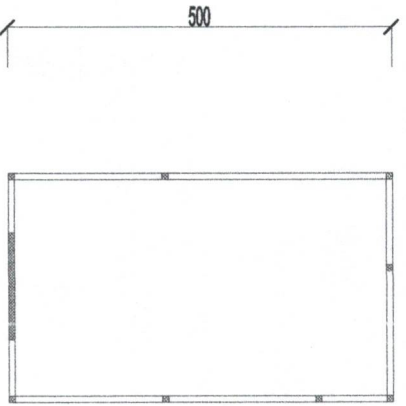

POKMAS KELEDANG JAYA

KEGIATAN

PEMBERDAYAAN KELURAHAN

SUB KEGIATAN

PEMBANGUNAN SARANA DAN PRASARANA KELURAHAN

PEKERJAAN

POSYANDU (TAHAP 2)

3 x 5

LOKASI

JL. HASAN BASRI
RT. 09

MENGETAHUI / MENYETUJUI

LURAH SUNGAI KELEDANG

RAHMADI, S.P.

NIP. 1982081 200502 1 004

TENAGA PENDAMPING

NOOR QALBI

KETUA POKMAS

MUSLIM

KETERANGAN

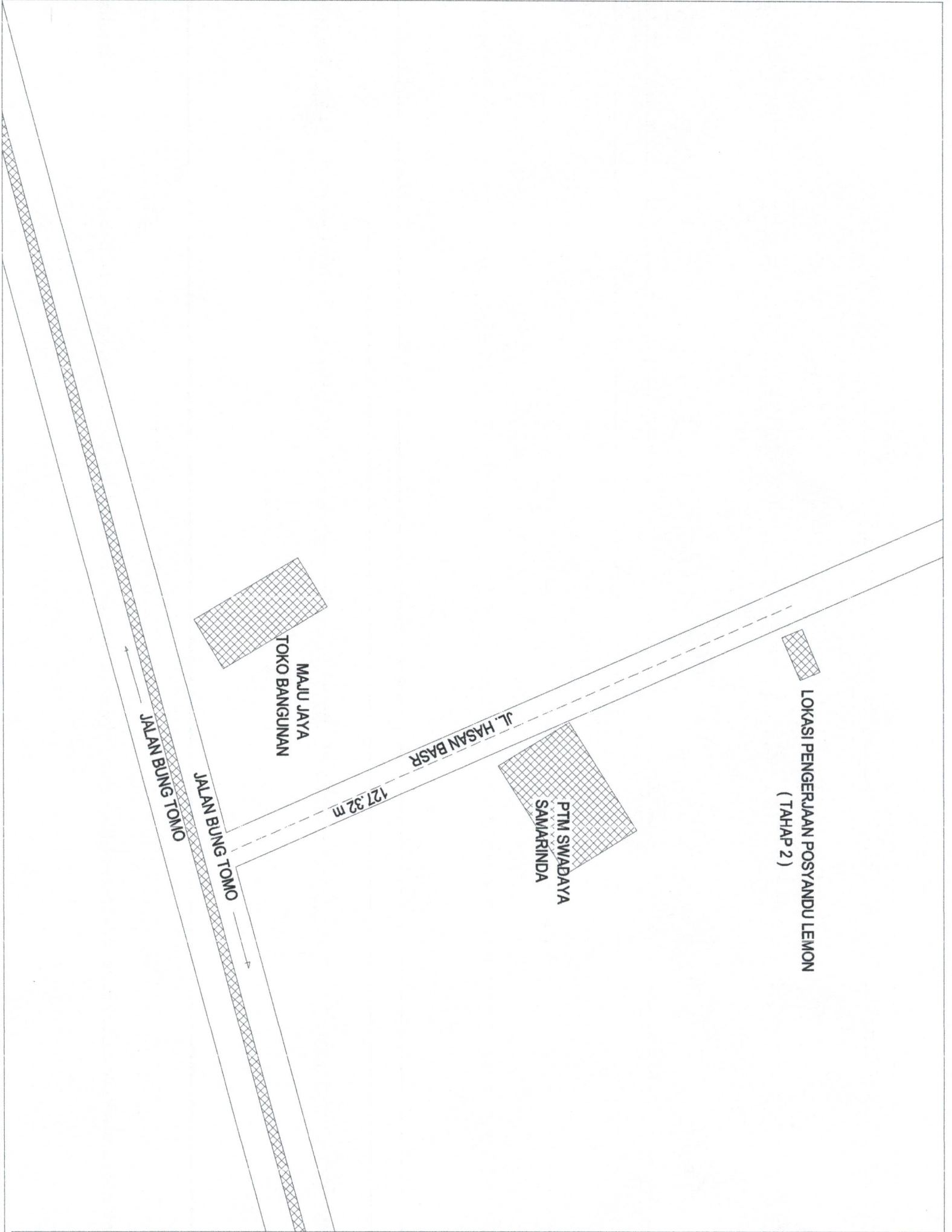

**LOKASI Pengerjaan POSYANDU LEMON
(TAHAP 2)**



POKMAS KELEDANG JAYA

KEGIATAN

PEMBERDAYAAN KELURAHAN

SUB KEGIATAN

PEMBANGUNAN SARANA DAN PRASARANA KELURAHAN

PEKERJAAN

**POSYANDU (TAHAP 2)
3 x 5**

LOKASI

**JL. HASAN BASRI
RT. 09**

MENGETAHUI / MENYETUJUI

LURAH SUNGAI KELEDANG

RAHMADI, S.P.

NIP 19820831 200502 1 004

TENAGA PENDAMPING

NOOR QALBI

KETUA POKMAS





MUSLIM

KETERANGAN

**RENCANA ANGGARAN BELANJA
BIDANG INFRASTRUKTUR**

Kota : Samarinda
Kec : Samarinda seberang
Kel : Sungai Keledang

Kegiatan : Jembatan
Volume : 20 x 2 x 2
80 M3
Lokasi RT : 10, Jl. Hj. Jahrah

NO	URAIAN	SAT	VOL	HARGA SATUAN	TOTAL HARGA
1	2	3	4	5	6
1	Upah				
	1. Tukang	OH	22.00	Rp 150,000	3,300,000
	3. Pekerja	OH	29.00	Rp 110,000	3,190,000
	Sub Total Upah (1)				6,490,000
2	Bahan				
	1. Kayu Perancah	Batang	19.39	Rp 49,000	950,000
	2. Papan Bauwplank	Lembar	25.00	Rp 27,000	675,000
	3. Papan Ulin panjang 2/16 x 4 m	Lembar	78.00	85,000	6,630,000
	4. Balok ulin 4/8 x 4 m	Batang	90.00	84,000	7,560,000
	5. Balok Ulin 8/8 x 4 m	Batang	55.00	168,000	9,240,000
	6. Paku 2. 3. 4 inc	Kg	8.35	26,000	217,000
	7. Baut 3/8 - 10cm	pasang	10.36	33,000	342,000
	Sub Total Bahan (2)				25,614,000
	Jumlah Total biaya (1 + 2 + 3)				32,104,000
	Pembulatan				32,104,000
 Menyetujui Lurah Sungai Keledang  RAHMADI NIP.19820831 200502 1 004		Pendamping  NOOR QALBI		POKMAS KELEDANG JAYA Ketua   MUSLIM	

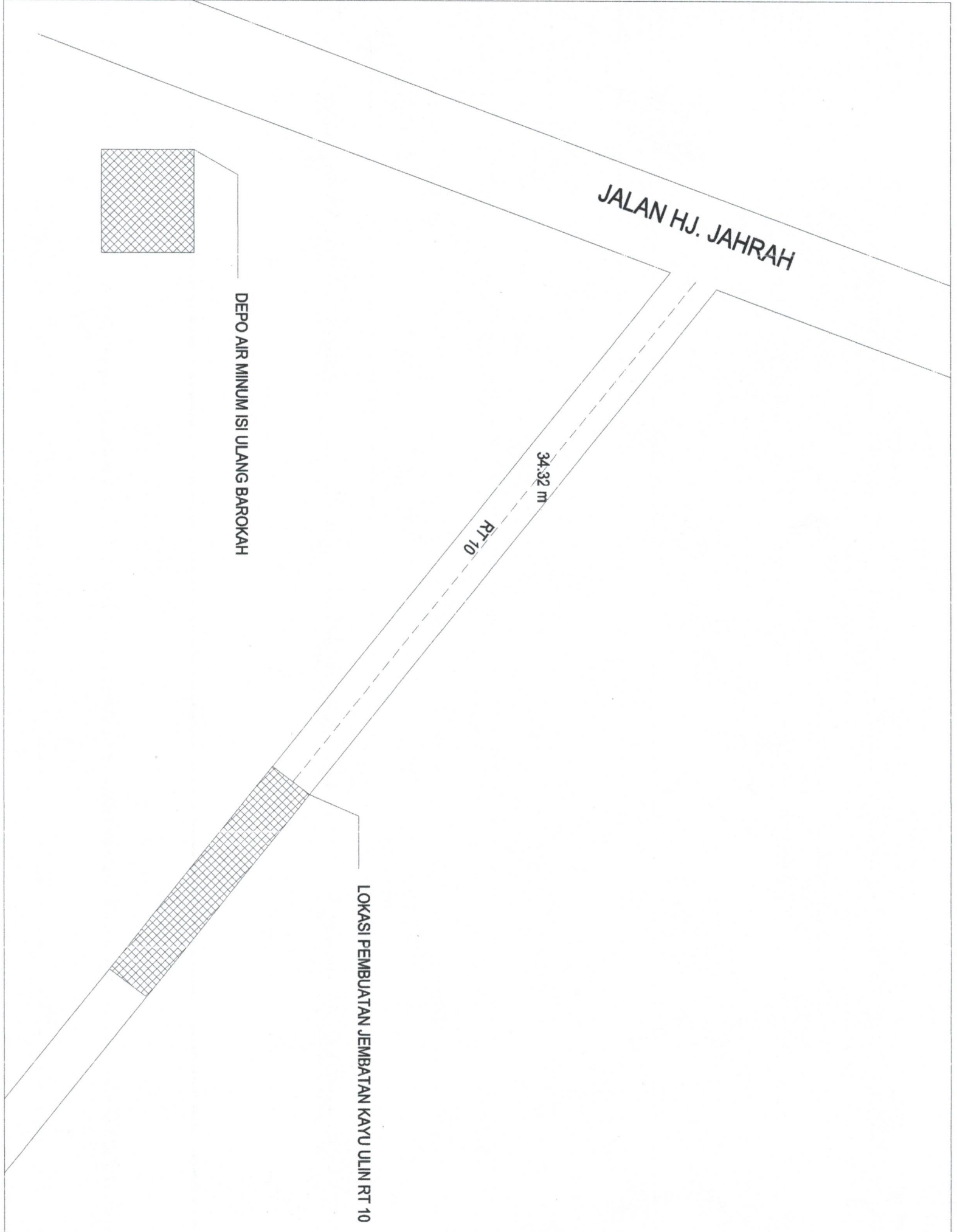

POKMAS KELEDANG JAYA

KEGIATAN

PEMEBERDAYAAN KELURAHAN

SUB KEGIATAN

PEMBANGUNAN SARANA DAN PRASARANA KELURAHAN

PEKERJAAN

JEMBATAN ULIN
20 x 2 x 2

LOKASI

JL. HJ. JAHRAH
RT. 02

MENGETAHUI / MENYETUJUI

LURAH SUNGAI KELEDANG

[Signature]
RAHMADI, S.P.

NIP. 19820131 200502 1 004

TENAGA PENDAMPING

[Signature]

NOOR QALBI

KETUA POKMAS

[Signature]
MUSLIM
KETERANGAN

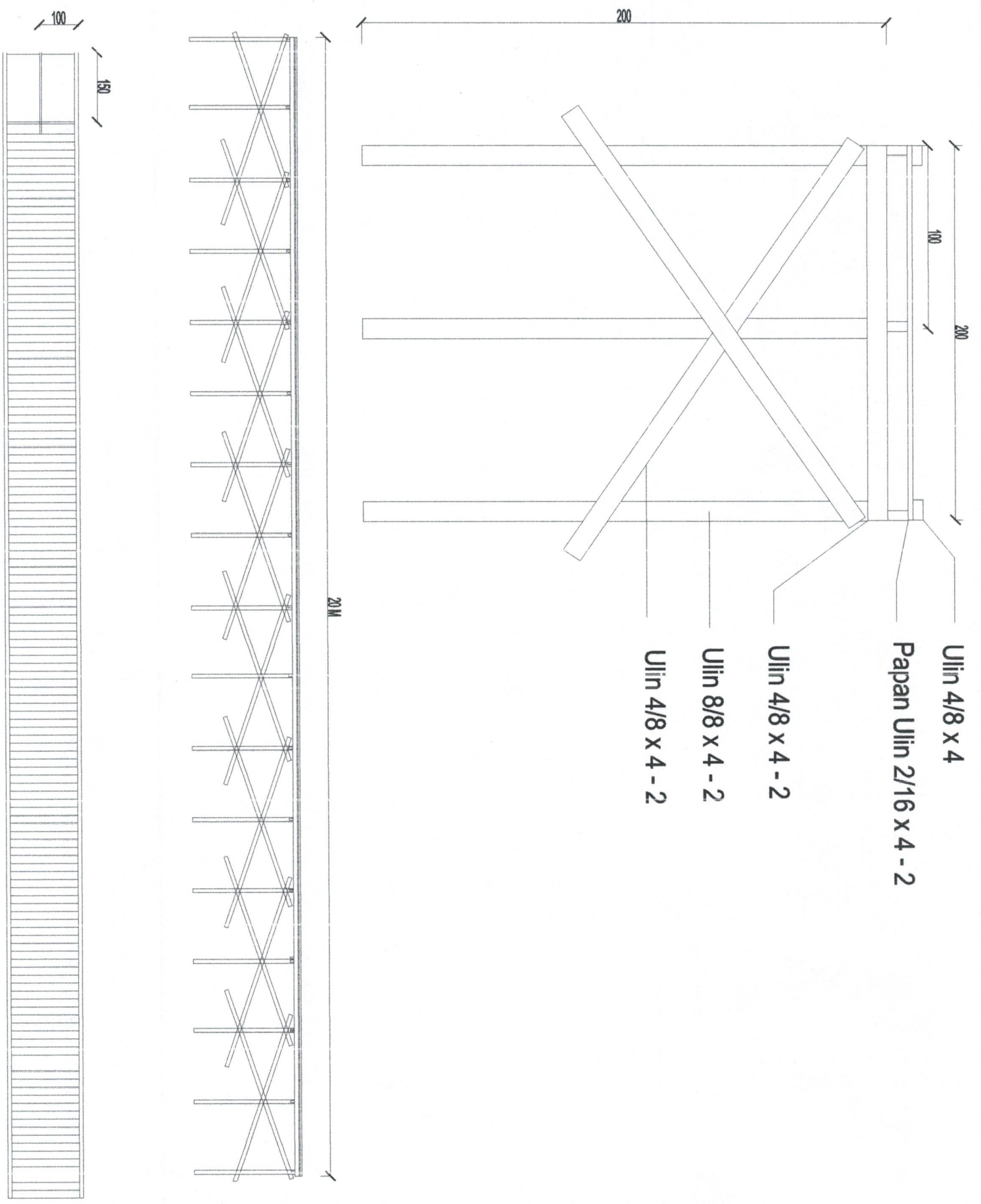

POKMAS KELEDANG JAYA

KEGIATAN

PEMBERDAYAAN KELURAHAN

SUB KEGIATAN

PEMBANGUNAN SARANA DAN PRASARANA KELURAHAN

PEKERJAAN

JEMBATAN ULIN
20 x 2 x 2

LOKASI

JL. HJ. JAHRAH
RT. 02

MENGETAHUI / MENYETUJI

LURAH SUNGAI KELEDANG

[Signature]
RAHMADI, S.P.
NIP 19820831 200502 1 004

TENAGA PENDAMPING

[Signature]
NOOR QALBI





KETUA POKMAS

[Signature]
MUSLIM
KETERANGAN

**RENCANA ANGGARAN BELANJA
BIDANG INFRASTRUKTUR**

Kota : Samarinda
Kec : Samarinda seberang
Kel : Sungai Keledang

Kegiatan : Pagar Ulin siring & Cor halaman
Volume : 12 x 2 & 1.5 x 4 x 0.12
24 & 0.72 M3
Lokasi RT : 10, Jl. Hj. Jahrah

NO	URAIAN	SAT	VOL	HARGA SATUAN	TOTAL HARGA
1	2	3	4	5	6
1	Upah				
	1. Tukang	OH	20.00	Rp 150,000	3,000,000
	2. Pekerja	OH	20.00	Rp 110,000	2,200,000
	Sub Total Upah (1)				5,200,000
2	Bahan Pagar				
	1. Papan Ulin Siring Pagar	Lembar	81.00	31,250	2,531,250
	2. Balok ulin 4/8 x 4 m	Batang	22.00	84,000	1,848,000
	3. Semen 50 kg	Zak	6.00	65,000	390,000
	4. Pasir Palu	M3	2.00	575,000	1,150,000
	5. Batu koral Palu	M3	1.00	367,500	367,500
	6. Paku 2. 3 inc	Kg	8.88	26,000	230,750
	Sub Total Bahan (2)				6,517,500
4	Bahan Cor Halaman Posyandu				
	1. Semen 50 kg	Zak	10.00	65,000	650,000
	2. Batu Pecah 1 - 2 cm	M3	1.00	367,500	367,500
	3. Betonmix (Cairan Cor)	kg	5.00	45,000	225,000
	4. Pasir Palu	M3	1.00	575,000	575,000
	Sub Total Bahan (3 , 4)				1,817,500
	Jumlah Total biaya (1 + 2 + 3 + 4)				13,535,000
	Pembulatan				13,535,000
	 Menyetujui Lurah Sungai Keledang  RANMADI NIP.19820831 200502 1 004	Pendamping  NOOR QALBI	POKMAS KELEDANG JAYA Ketua   MUSLIM		

LOKASI PEMBANGUNAN PAGAR POSYANDU

JALAN HJ. JAHRAH

1,5 m

GANG DAMAI



POKMAS KELEDANG JAYA

KEGIATAN

PEMBERDAYAAN KELURAHAN

SUB KEGIATAN

PEMBANGUNAN SARANA DAN PRASARANA KELURAHAN

PEKERJAAN

PAGAR POSYANDU

2 x 12

LOKASI

JL. HJ. JAHRAH
RT. 10

MENGETAHUI / MENYETUJUI

LURAH SUNGAI KELEDANG

R. H. M. D., S.P.

NIP. 19820831 200502 1 004

TENAGA PENDAMPING

NOOR QALBI

KETUA POKMAS

MUSLIM

KETERANGAN



POKMAS KELEDANG JAYA

KEGIATAN

PEMBERDAYAAN KELURAHAN

SUB KEGIATAN

PEMBANGUNAN SARANA DAN PRASARANA KELURAHAN

PEKERJAAN

PAGAR POSYANDU
2 x 12

LOKASI

JL. HJ. JAHRAH
RT. 10

MENGETAHUI / MENYETUJUI

LURAH SUNGAI KELEDANG

RAHMADI, S.P.

NIP. 19820831 200502 1 004

TENAGA PENDAMPING

NOOR QALBI

KETUA POKMAS

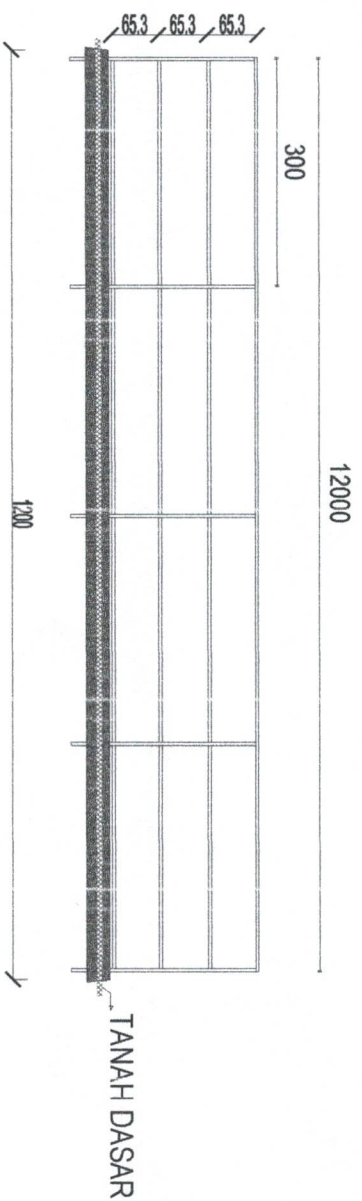





MUSLIM

KETERANGAN

**RENCANA ANGGARAN BELANJA
BIDANG INFRASTRUKTUR**

Kota : Samarinda
Kec : Samarinda seberang
Kel : Sungai Keledang

Kegiatan : Pondasi Tandon
Volume : 2 x 2 x 1.5
6 M3
Lokasi RT : 10, Jl. Hj. Jahrah

NO	URAIAN	SAT	VOL	HARGA SATUAN	TOTAL HARGA
1	2	3	4	5	6
1	Upah				
	1. Tukang	OH	5.00	Rp 150,000	750,000
	2. Pekerja	OH	5.00	Rp 110,000	550,000
	Sub Total Upah (1)				1,300,000
2	Bahan				
	3. Papan Ulin panjang 2/16 x 4 m	Lembar	8.00	85,000	680,000
	4. Balok ulin 4/8 x 4 m	Batang	6.00	84,000	504,000
	5. Balok Ulin 8/8 x 4 m	Batang	3.00	168,000	504,000
	6. Paku 2. 3 inc	Kg	2.19	26,000	57,000
	7. Baut 3/8 - 10cm	pasang	2.00	33,000	66,000
	Sub Total Bahan (2)				1,811,000
	Jumlah Total biaya (1 + 2 + 3)				3,111,000
	Pembulatan				3,111,000
 Menyetujui Lurah Sungai Keledang  RAHMADI NIP.19820831 200502 1 004		Pendamping  NOOR QALBI		POKMAS KELEDANG JAYA Ketua   MUSLIM	

PONDASI TANDON

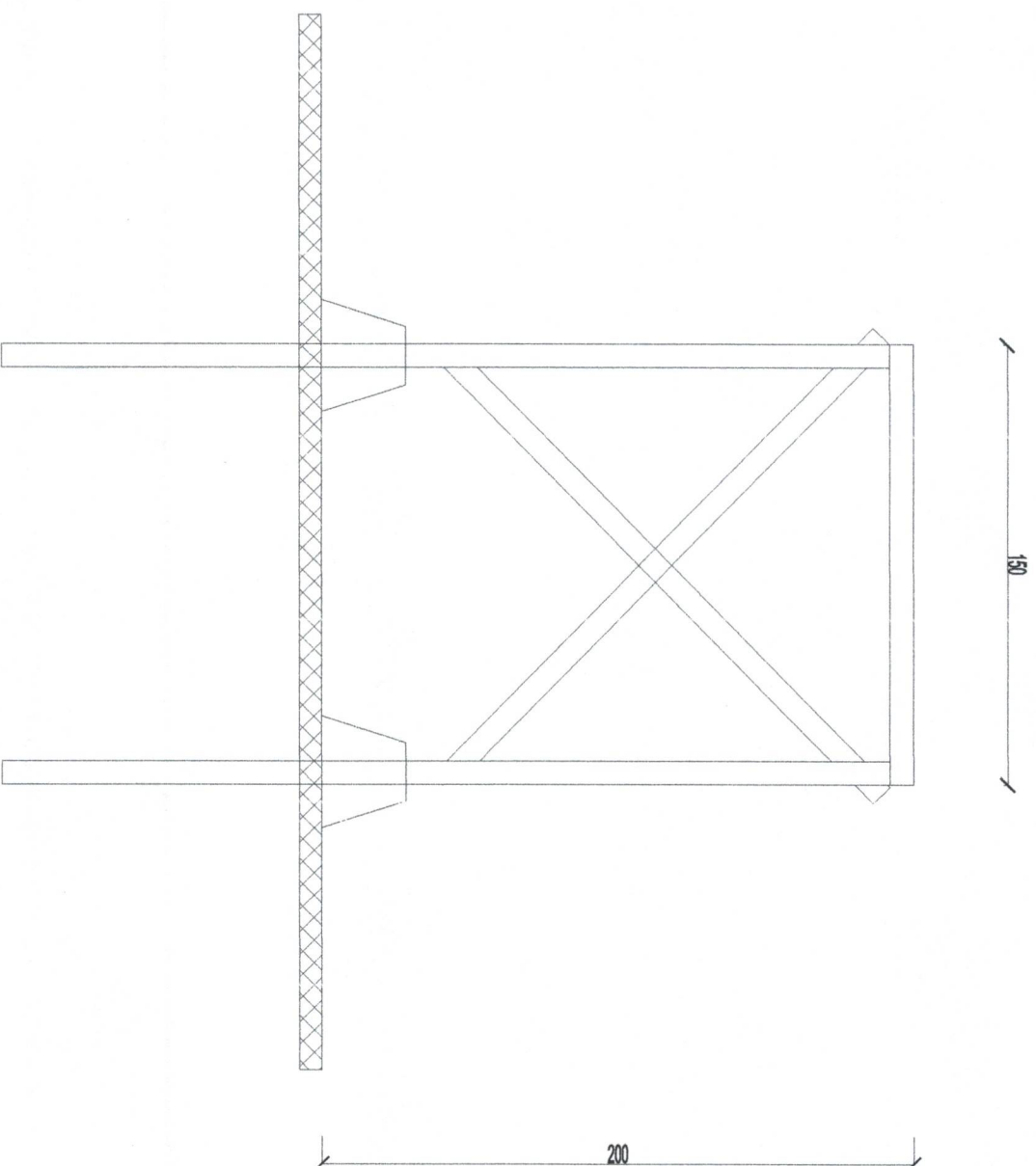

POKMAS KELEDANG JAYA

KEGIATAN

PEMBERDAYAAN KELURAHAN

SUB KEGIATAN

PEMBANGUNAN SARANA DAN PRASARANA KELURAHAN

PEKERJAAN

PONDASI TANDON POSYANDU
1,5 x 2

LOKASI

JL. HU JAHRAH
RT. 10

MENGETAHUI / MENSETUJUI

LURAH SUNGAI KELEDANG

RAKHMADI, S.P.

NIP. 19820831 200502 1 004

TENAGA PENDAMPING

NOOR QALBI

KETUA POKMAS

MUSLIM

KETERANGAN

**RENCANA ANGGARAN BELANJA
BIDANG INFRASTRUKTUR**

Kota : Samarinda
Kec : Samarinda seberang
Kel : Sungai Keledang

Kegiatan : Semenisasi
Volume : 41 x 1.5 x 0.15
9.225 M3

Lokasi RT : 11, Jl. Hj. Jahrah Gg. Ash Shabirin

NO	URAIAN	SAT	VOL	HARGA SATUAN	TOTAL HARGA
1	2	3	4	5	6
1	Upah				
	1. Tukang	HOK	15.00	Rp 150,000	2,250,000
	2. Pekerja	HOK	30.00	Rp 110,000	3,300,000
	Sub Total Upah (1)				5,550,000
2	Bahan				
	1. Semen 50 kg	Zak	75.00	65,000	4,875,000
	2. Plywod 9 mm	Lembar	12.00	126,500	1,518,000
	3. Balok 5/7 x 4m	Potong	23.00	45,000	1,035,000
	4. Pasir Palu	M2	12.00	575,000	6,900,000
	5. Paku 2, 3 "	Kg	3.73	26,000	97,000
	6. Plastik Cor	M3	98.00	2,750	269,500
	7. BBM jenis Bio Solar	Liter	120.00	5,150	618,000
	8. Kawat Harmonika Lobang Besar	M3	50.00	25,000	1,250,000
	9. Betonmix (cairan beton)	kg	15.00	45,000	675,000
	10. Batu Pecah 1 - 2 cm	M2	9.00	367,500	3,307,500
	Sub Total Bahan (2)				20,545,000
3	Alat Bantu				
	1. Drum Plastik Sedang	buah	1.00	250,000	250,000
	2. Gerobak / Artco	Buah	4.00	490,000	1,960,000
	3. Sewa Alat Molen	Jam	14.00	367,500	5,145,000
	Sub Total Sewa Alat (3)				7,105,000
	Jumlah Total biaya (1 + 2 + 3)				33,200,000
	Pembulatan				32,200,000

 Menyetujui
 Lurah Sungai Keledang

RAHMADI
 NIP.19820831 200502 1 004

Pendamping



NOOR QALBI

POKMAS KELEDANG JAYA

 Ketua

MUSLIM



POKMAS KELEDANG JAYA

KEGIATAN

PEMBERDAYAAN KELURAHAN

SUB KEGIATAN

PEMBANGUNAN SARANA DAN
PRASARANA KELURAHAN

PEKERJAAN

SEMENISASI
41 x 1,5 x 0,15

LOKASI

JL. HJ. JAHRAH GG. ASH SHABIRIN
RT. 11

MENGETAHUI / MENYETUJUI

LURAH SUNGAI KELEDANG



KAHMADI, S.P.
NIP. 19820831 200502 1 004

TENAGA PENDAMPING

NOOR QALBI

KETUA POKMAS

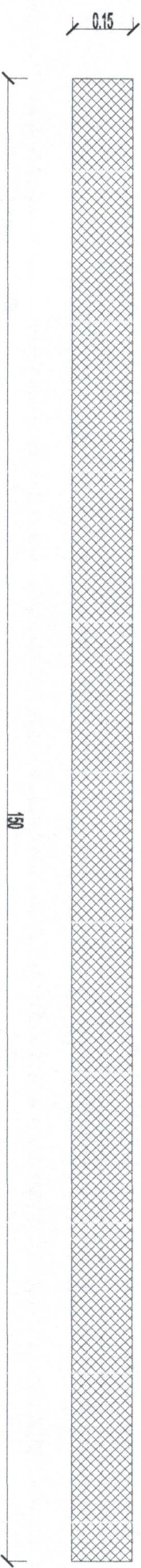
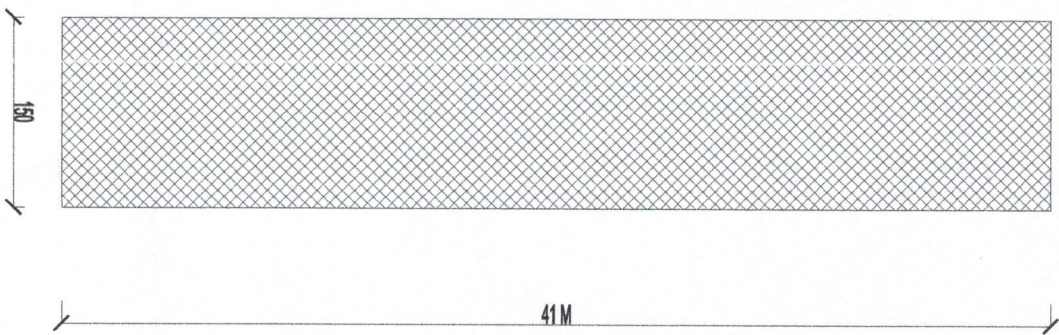
MUSLIM
KETERANGAN



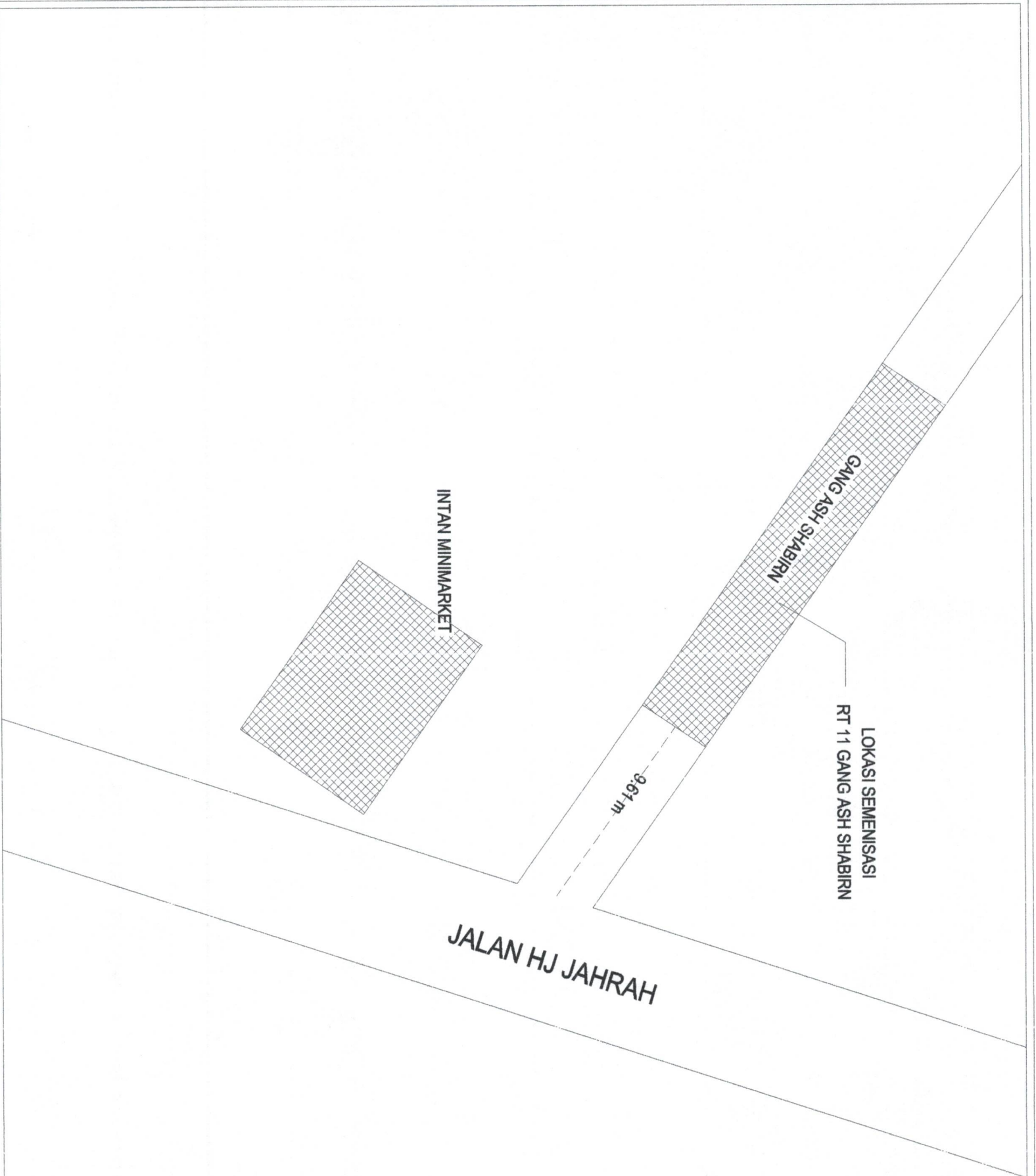

POKMAS KELEDANG JAYA

KEGIATAN

PEMBERDAYAAN KELURAHAN

SUB KEGIATAN

PEMBANGUNAN SARANA DAN PRASARANA KELURAHAN

PEKERJAAN

SEMENISASI

41 x 1.5 x 0.15

LOKASI

JL. HJ. JAHRAH GG. ASH SHABIRIN
RT. 11

MENGETAHUI / MENSETUJUI

LURAH SUNGAI KELEDANG

[Signature]
RATMADI, S.P.
NIP. 198208312005021004

TENAGA PENDAMPING

[Signature]
NOOR QALBI

KETUA POKMAS

[Signature]
MUSLIM
KETERANGAN

**RENCANA ANGGARAN BELANJA
BIDANG INFRASTRUKTUR**

Kota : Samarinda
Kec : Samarinda seberang
Kel : Sungai Keledang

Kegiatan : Gapura
Volume : 3.5 x 3.5
80 M3
Lokasi RT : 11 Jl. Hj. Jaharah Gg. Uli

NO	URAIAN	SAT	VOL	HARGA SATUAN	TOTAL HARG
1	2	3	4	5	6
1 Upah					
	1. Tukang	OH	25.00	Rp 150,000	3,750,0
	2. Pekerja	OH	19.00	Rp 110,000	2,090,0
	Sub Total Upah (1)				5,840,0
2 Bahan					
	1. Pipa Stainless 304 tebal 1.5mm - 1 inch	M2	35.00	Rp 60,000	2,100,0
	2. Pipa stainless 304 2" inch x 6 m tebal 1,5 mm	M2	35.00	Rp 70,000	2,450,0
	3. Plat stainless 1 mm x 1220 mm x 2440 mm / sus 304	Lembar	1.00	Rp 1,800,000	1,800,0
	4. Semen 50 kg	1	4.00	65,000	260,0
	5. Pasir Palu	m3	1.00	575,000	575,0
	6. Batu Pecah	m3	1.00	367,500	367,5
	7. Paku 2. 3 inc	Kg	5.06	26,000	131,5
	8. Plywod 9mm	Lembar	2.00	126,500	253,0
	9. Kayu Perancah	m3	0.33	2,200,000	723,0
	Sub Total Bahan (2)				8,660,0
					14,500,0
	Pembulatan				14,500,0

Menyetujui
Lurah Sungai Keledang



RAHMADI
NIP.19820831 200502 1 004

Pendamping



NOOR QALBI

POKMAS KELEDANG JAYA

Ketua

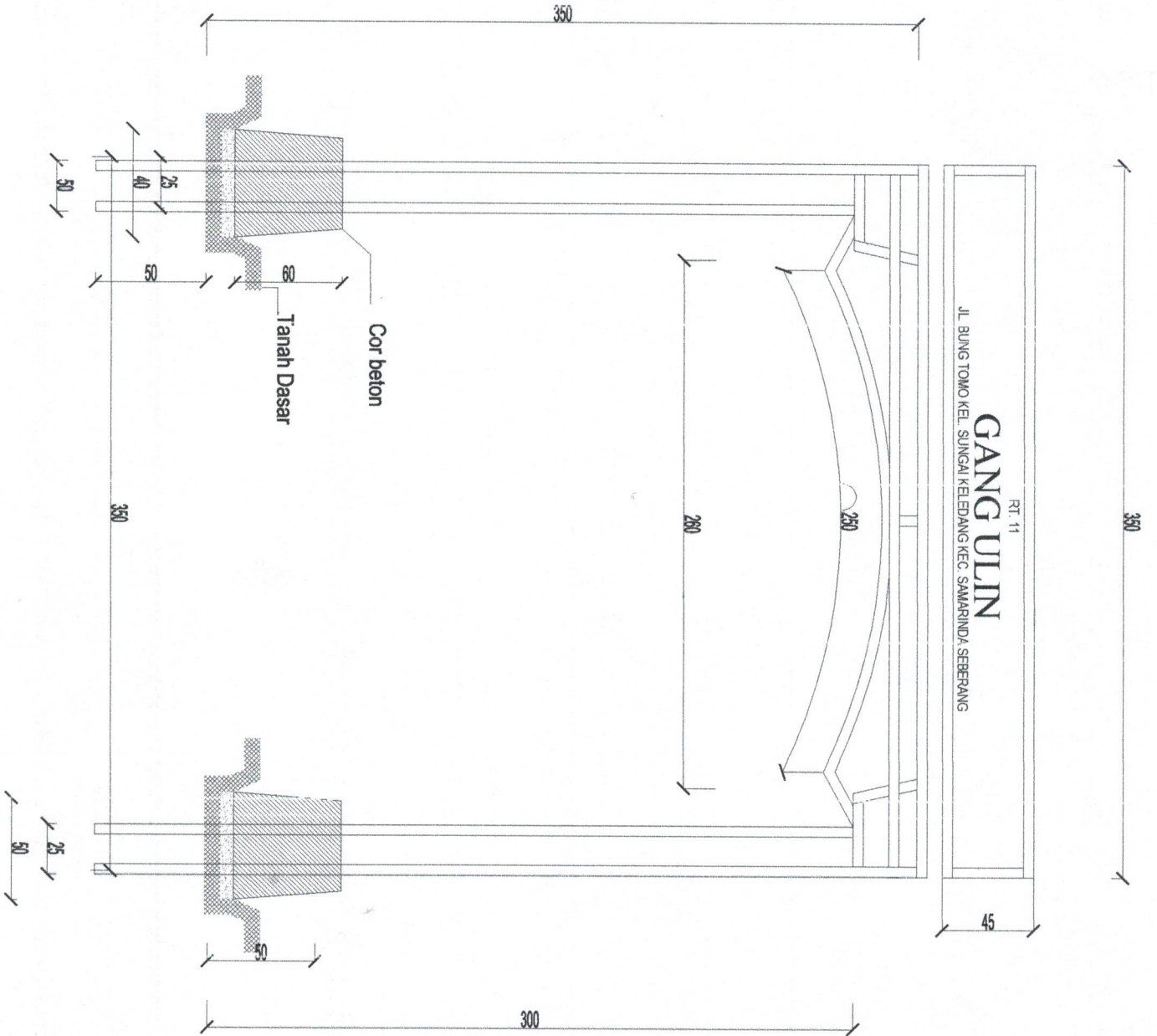

MUSLIM



POKMAS KELEDANG JAYA

KEGIATAN

PEMBERDAYAAN KELURAHAN

SUB KEGIATAN

PEMBANGUNAN SARANA DAN PRASARANA KELURAHAN

PEKERJAAN

GAPURA
3,5 x 3,5

LOKASI

JL. HJ. JAHRAH GG. ULIN
RT. 11

MENGETAHUI / MENYETUJUI

LURAH SUNGAI KELEDANG

RAHMADI, S.P.

NIP. 19820831 200502 1 004

TENAGA PENDAMPING

NOOR QALBI

KETUA POKMAS

[Signature]
MUSLIM
KETERANGAN

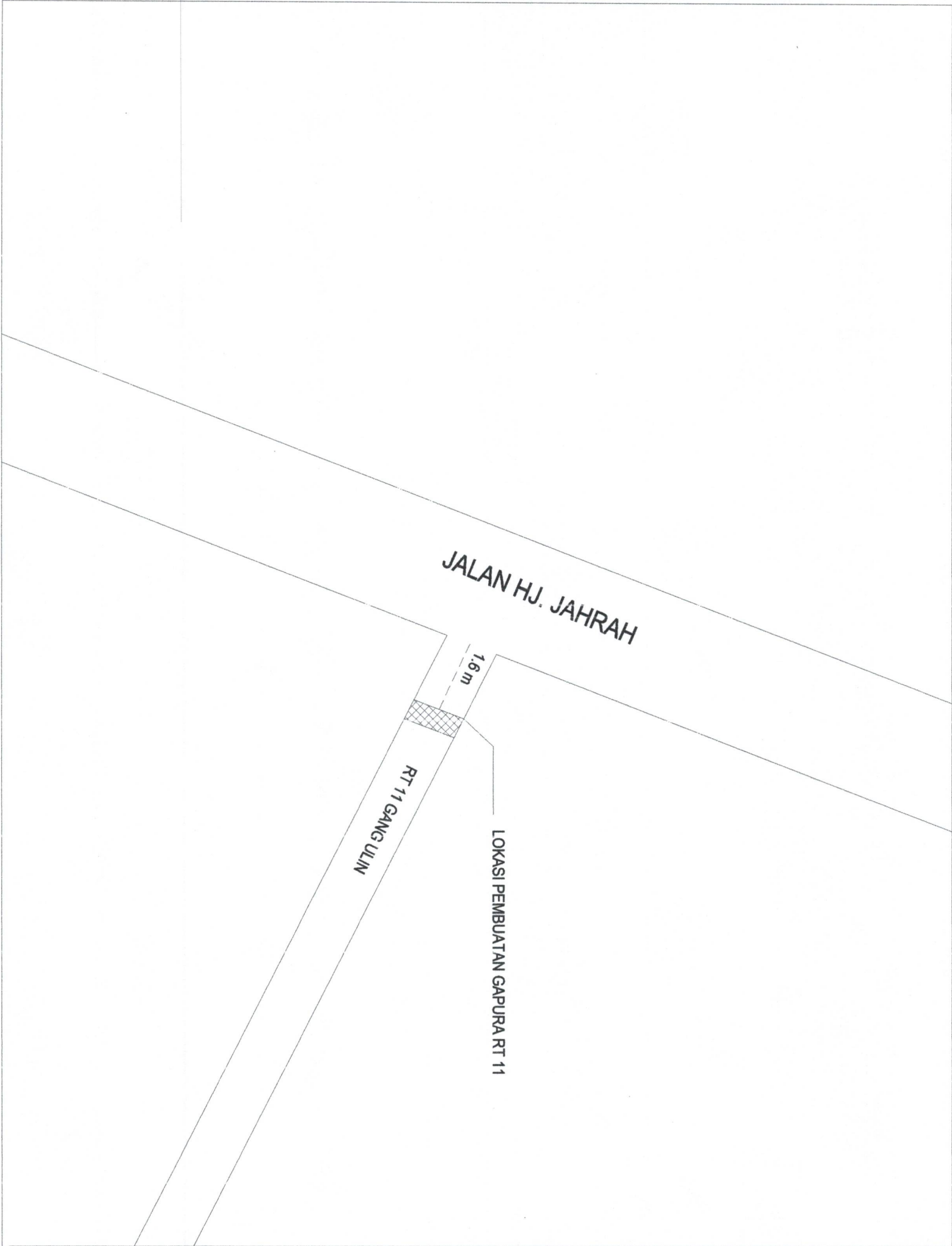

POKMAS KELEDANG JAYA

KEGIATAN

PEMBERDAYAAN KELURAHAN

SUB KEGIATAN

PEMBANGUNAN SARANA DAN PRASARANA KELURAHAN

PEKERJAAN

GAPURA

3.5 x 3.5

LOKASI

JL. HJ. JAHRAH GG. ULIN

RT. 11

MENGETAHUI / MENSETUJUI

LURAH SUNGAI KELEDANG

[Signature]

RAHMADI, S.P.

NIP. 19820881 200502 1 004

TENAGA PENDAMPING

[Signature]

NOOR QALBI

KETUA POKMAS

[Signature]

MUSLIM

KETERANGAN





**RENCANA ANGGARAN BELANJA
BIDANG INFRASTRUKTUR**

Kota : Samarinda
Kec : Samarinda seberang
Kel : Sungai Keledang

Kegiatan : Semenisasi
Volume : 25 x 2 x 0.15

8 M3

Lokasi RT : 12, Jl. Hj. Jahrah

NO	URAIAN	SAT	VOL	HARGA SATUAN	TOTAL HARGA
1	2	3	4	5	6
1	Upah				
	1. Tukang	OH	10.00	Rp 150,000	1,500,000
	3. Pekerja	OH	20.00	Rp 110,000	2,200,000
	Sub Total Upah (1)				3,700,000
2	Bahan Semenisasi				
	1. Semen 50 kg	Kg	54.00	65,000	3,510,000
	2. Batu Pecah	M3	6.00	367,500	2,205,000
	3. Pasir Palu	M3	7.00	575,000	4,025,000
	4. Plywod 9mm	Lembar	4.00	126,500	506,000
	5. Balok Kayu 5/7 x 4 m	M3	8.00	45,000	360,000
	6. Paku 2, 3 inc	kg	3.54	26,000	92,100
	7. Betonmix (Cairan Cor)	kg	8.00	45,000	360,000
	7. Plastik Cor	Meter	60.00	2,750	165,000
					11,223,100
3	Alat Bantu				
	2. Gerobak Arco	buah	2.00	490,000	980,000
	3. Drum Plastik	buah	1.00	250,000	250,000
	Sub Total Bahan (2)				1,230,000
	Jumlah Total biaya (1 + 2 + 3)				16,153,100
	Pembulatan				16,154,000
 Menyetujui Lurah Sungai Keledang  RAHMADI NIP.19820831 200502 1 004		Pendamping  NOOR QALBI		POKMAS KELEDANG JAYA Ketua   MUSLIM	

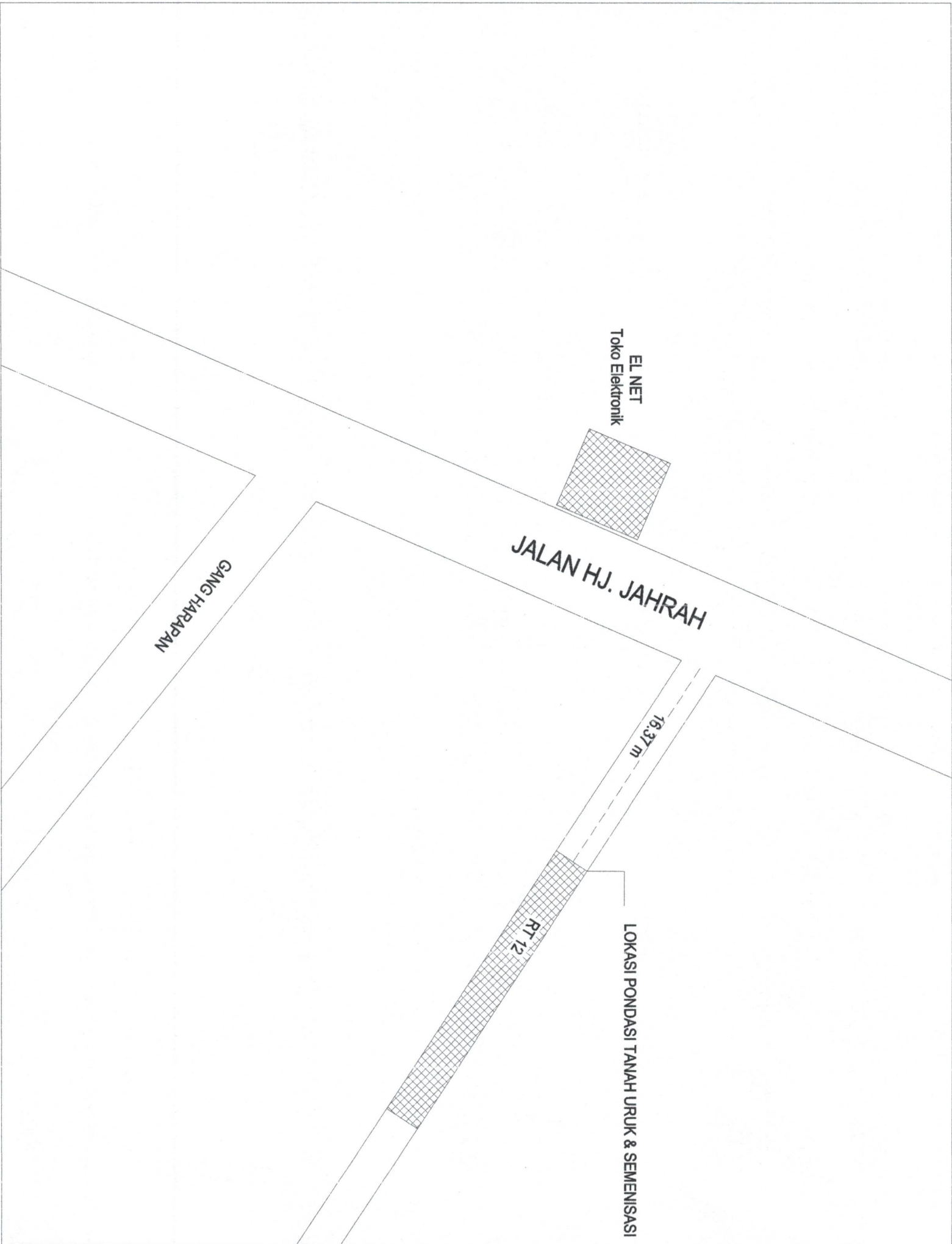

POKMAS KELEDANG JAYA

KEGIATAN

PEMBERDAYAAN KELURAHAN

SUB KEGIATAN

PEMBANGUNAN SARANA DAN PRASARANA KELURAHAN

PEKERJAAN

PARIT
PONDASI URUKAN & SEMENISASI
25 x 2 x 0.7

LOKASI

JL. HJ. JAHRAH

RT. 12

MENGETAHUI / MENYETUJUI

LURAH SUNGAI KELEDANG

[Signature]
RAHMADI, S.P.

NIP. 19820831 200502 1 004

TENAGA PENDAMPING

[Signature]

NOOR QALBI





KETUA POKMAS

[Signature]
MUSLIM
KETERANGAN

**RENCANA ANGGARAN BELANJA
 BIDANG INFRASTRUKTUR**

Kota : Samarinda
 Kec : Samarinda seberang
 Kel : Sungai Keledang

Kegiatan : Turap Urukun
 Volume : 25 x 2 x 0.70
 35 M3
 Lokasi RT : 12, Jl. Hj. Jahrah

NO	URAIAN	SAT	VOL	HARGA SATUAN	TOTAL HARGA
1	2	3	4	5	6
1	Upah				
	1. Tukang	OH	15.00	Rp 150,000	2,250,000
	3. Pekerja	OH	25.00	Rp 110,000	2,750,000
	Sub Total Upah (1)				5,000,000
2	Bahan Urukun				
	1. Semen 50 kg	zak	120.00	Rp 65,000	7,800,000
	2. Batu Padas	m3	18.00	Rp 315,700	5,682,600
	3. Pasir Mahakam	m3	13.00	198,000	2,574,000
	4. Tanah Urug	M3	36.00	150,000	5,400,000
	5. Balok Ulin 8/8 x 4 m	Batang	30.00	168,000	5,040,000
	6. Paku 2, 3 inc	Kg	13.44	26,000	349,400
	Sub Total Bahan (2)				26,846,000
	Sub Total (1 + 2)				31,846,000
	Pembulatan				31,846,000
 Menyetujui Lurah Sungai Keledang  RAHMADI NIP.19820831 200502 1 004		Pendamping  NOOR QALBI		POKMAS KELEDANG JAYA Ketua   MUSLIM	

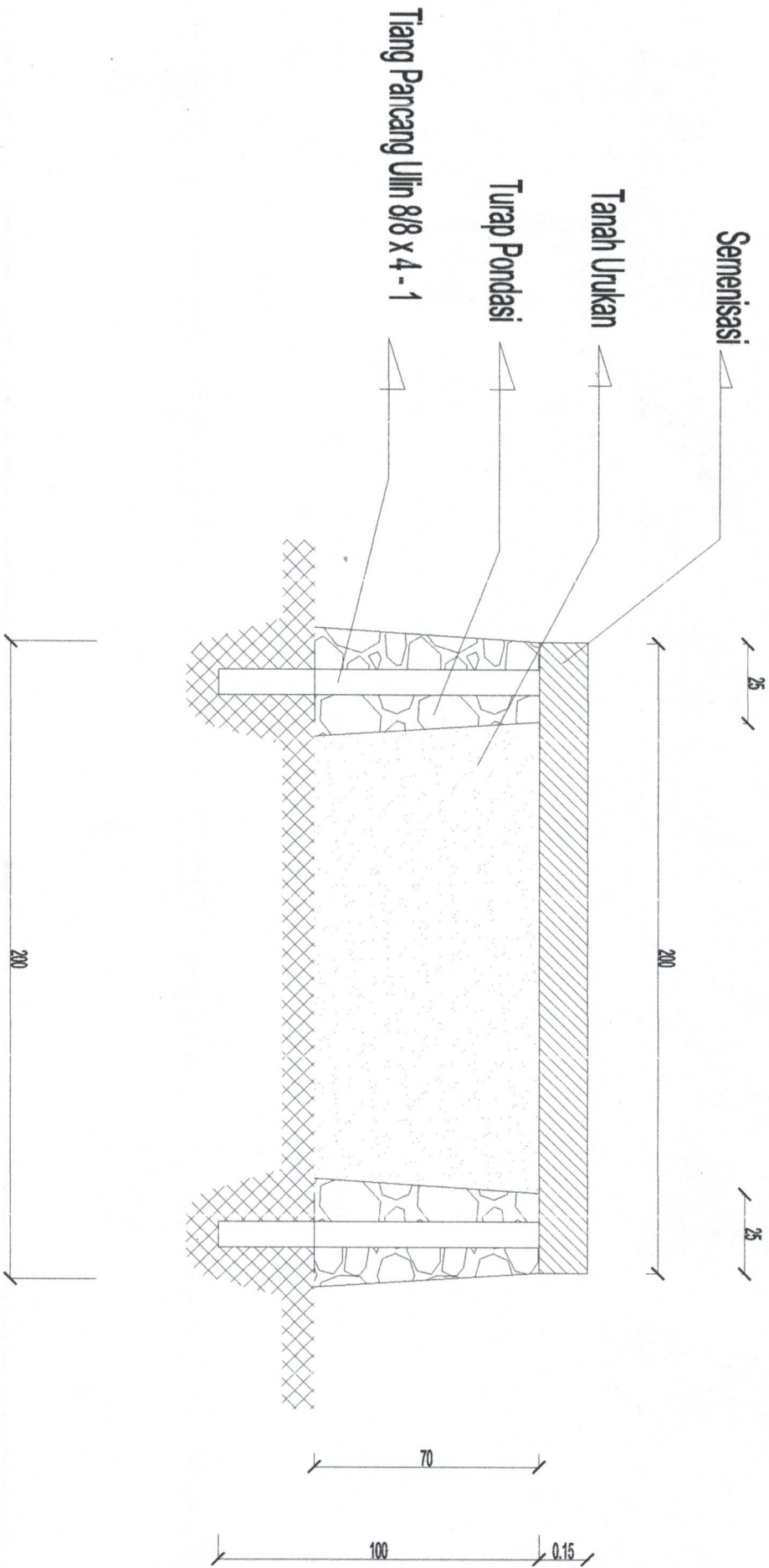

POKMAS KELEDANG JAYA

KEGIATAN

PEMBERDAYAAN KELURAHAN

SUB KEGIATAN

PEMBANGUNAN SARANA DAN PRASARANA KELURAHAN

PEKERJAAN

PARIT
PONDASI URUKAN & SEMENISASI
25 x 2 x 0.7

LOKASI

JL. HJ. JAHRAH
RT. 12

MENGETAHUI / MENYETUJUI

LURAH SUNGAI KELEDANG

[Signature]

RAHMADI, S.P.
NIP. 19820831 200502 1 004

TENAGA PENDAMPING

[Signature]

NOOR QALBI

KETUA POKMAS

[Signature]
MUSLIM
KETERANGAN